

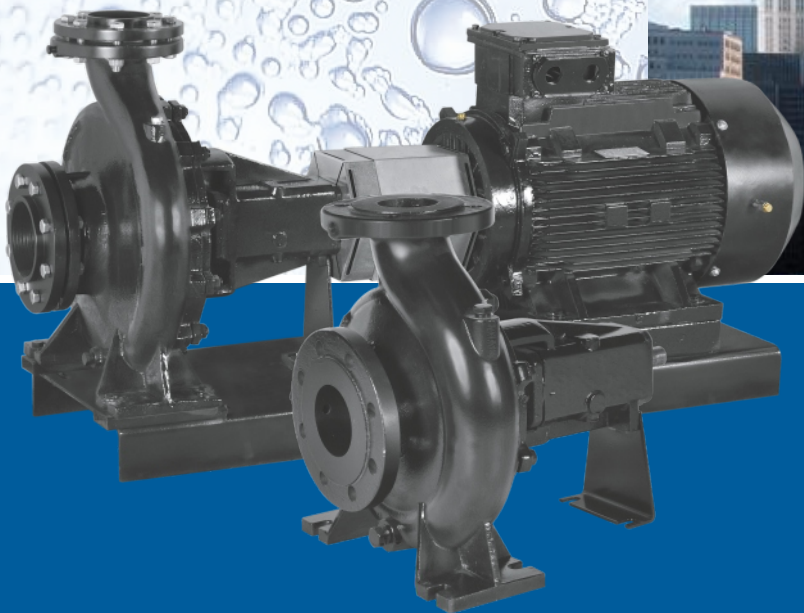

GENERAL PUMPS

**Bombas centrifugas
de eje libre Horizontales
60 Hz**

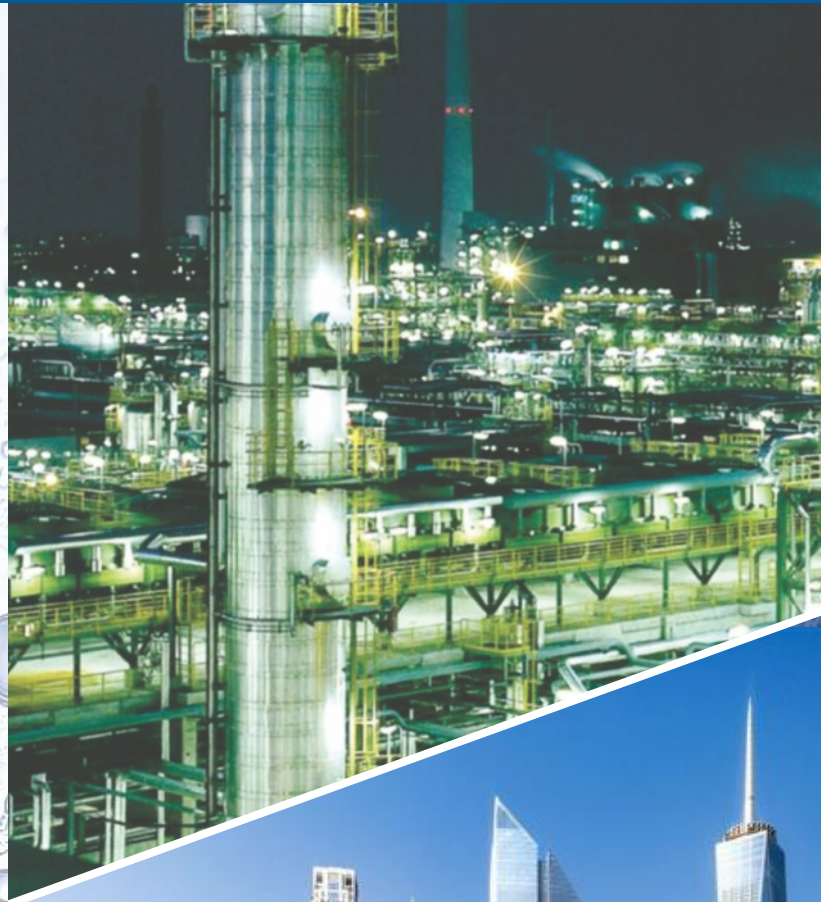

www.pumpsgp.com

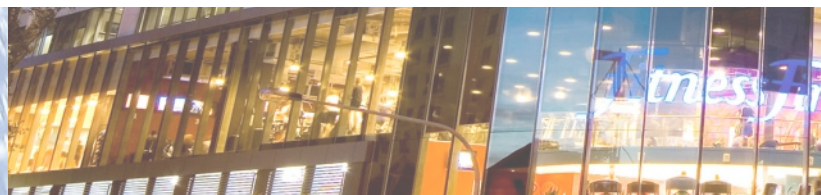

Contenido

Contents

Contenu

	Datos del producto Product Data Données de produit	Pg 4
	Datos del Motor Eléctrico Motor Electrical Data Données électriques de moteur	Pg 13
	Dimensiones de motor Motor Dimensions Dimensions moteur	Pg 14
	Gama de Rendimiento Performance Range Gamme de performances	Pg 15
	Bombas de Eje Libre Dimensiones y Pesos Bare Shaft Pumps Dimensions and Weights Axe de Pompe Dimensions et Poids	Pg 17
3450	Curvas Características de 2 Polos 2-Pole Characteristic Curves Courbes de caractéristiques Pole-2	Pg 18
3450	Dimensiones y pesos de 2 Polos 2-Pole Dimensions and Weights Dimensions et poids Pole-2	Pg 33
1750	Curvas Características de 4 Polos 4-Pole Characteristic Curves Courbes de caractéristiques Pole-4	Pg 36
1750	Dimensiones y pesos de 4 Polos 4-Pole Dimensions and Weights Dimensions et poids Pole-4	Pg 56
1150	Curvas Características de 6 Polos 6-Pole Characteristic Curves Courbes de caractéristiques Pole-6	Pg 60
1150	Dimensiones y pesos de 6 Polos 6-Pole Dimensions and Weights Dimensions et poids Pole-6	Pg 68
	Bancadas Base Frames Base d'armature	Pg 70
	Datos del producto Product Data Données de produit	Pg 71

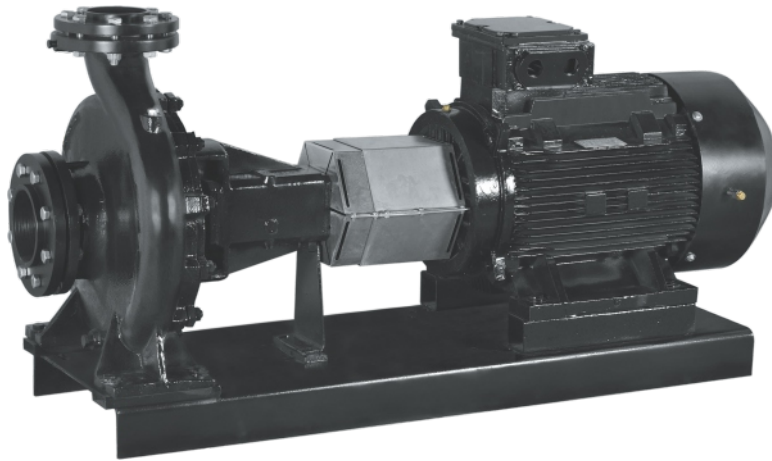

Construcción

Las GBS son bombas horizontales, de 1 etapa con eje libre según norma ISO 2858.

Nuestra gama también incluye varios modelos de bombas que han sido desarrolladas con el deber de condición de los derechos que no están cubiertas por la norma ISO 2858.

Aplicaciones

- Suministro de agua.
- Aumento de presión para edificios de gran altura, la industria hotelera, etc
- Lavado industrial y limpieza de sistemas.
- Sistemas de protección.
- Sistemas de refrigeración y aire acondicionado.
- Alimentación de calderas y el condensado del sistema de transferencia.
- Sistemas de riego para los campos incluyendo rociadores y sistemas de riego por goteo.



Construction

GBS are single-stage bare shaft end-suction pumps according to ISO 2858.

Our range also includes several model of pumps which have been developed with duty condition which are not covered in ISO 2858.

Applications

- Water supply.
- Pressure boosting for high rise buildings, hotels industry etc.
- Industrial washing and cleaning systems.
- Fire protection systems.
- Cooling and air conditioning systems.
- Boiler feed and condensate transfer system.
- Irrigation systems for fields including sprinkler and drip irrigation systems.



Construction

Le GBS sont les pompes d'extrémité-aspiration d'axe d'étape simple selon ISO 2858.

Notre gamme inclut également plusieurs modèles de pompes qui ont été développées avec une responsabilité qui n'est pas couvert avec ISO 2858.

Applications

- Approvisionnement en eau.
- Faites pression sur l'amplification pour les gratte-ciel, l'industrie hôtelière etc.
- Systèmes industriels de lavage et de nettoyage.
- Systèmes de protection contre les incendies.
- Dispositifs de refroidissement et de climatisation.
- Alimentation de chaudière et système de transfert condensat.
- Systèmes d'irrigation pour des champs comprenant l'arroseuse et systèmes d'irrigation par égouttement.

Principales características

Características de las bombas incluyendo algunas Destacados y enumerados a continuación:

- Estas bombas no son autocebantes. Son bombas centrífugas horizontales, de hierro fundido, con aspiración axial y descarga radial.
- El rendimiento de las bombas cumple con la ISO 2858.
- Las normas de bridas de aspiración y descarga, son ANSI 125 y ANSI 250, según ASME B16.1 DIN 1092-2 PN16. Y DIN EN 1092-2 PN25. Se pueden ofrecer bajo petición otro tipo.
- Las bombas tienen un rango de caudal de 35 a 3350 USgpm y un rango de altura manométrica de 12 a 470 ft.
- Las clasificaciones de motor van de 1 a 300 HP.
- Estas bombas son con acoplamiento a motor de inducción de jaula de ardilla TEFC con medidas principales que cumplan con las normas NEMA MG 1-2006.
- Estas bombas están disponibles con el Prensa-estopa, así como con sello del eje mecánico.
- Las bombas y los motores están disponibles con bancada fabricado en acero de acuerdo con la norma EN 23661.
- Los impulsores de la bomba están equilibrados dinámicamente al grado 6.3 de la norma ISO 1940.
- Estas bombas están disponibles con la eficacia alta motores para igualar o mejorar los requisitos de rendimiento de los E.E.U.U. ley política energética de 1992 (EPAct) y Recursos Naturales de Canadá, normas (RNCAN).
- La eficiencia es igual o superior a plena carga de los motores TEFC según la tabla 12-11 de normas NEMA MG 1-2006.
- También se puede suministrar los motores con eficiencia NEMA PREMIUM, TEFC según la tabla 12-12 de normas NEMA MG 1-2006 (opcional).
- Las bombas tienen un nuevo diseño extraíble. Esta función permite al usuario la extracción del motor, del impulsor y del soporte del cojinete para el servicio de reparación sin perturbar la Voluta ni las tuberías aspiración y entrega (ver figura inferior).
- Las bombas también se pueden suministrar con motores Estandar IEC.

Construcciones especiales

Frecuencia de 50 Hz (50 Hz según la hoja de datos).

Salient features

Features of the pumps including certain salient ones are listed as below:

- These pumps are non-self priming, horizontal, single-stage, centrifugal volute casing pumps with axial suction and radial discharge port.
- Performance of the pumps comply to ISO 2858.
- Standard flanges for suction and discharge ends are ANSI 125 and ANSI 250 as per ASME B16.1. DIN EN 1092-2 with PN 16 ratings and DIN EN 1092-2 with PN 25 ratings can also be offered on request.
- Pumps has the discharge range from 35 - 3350 USGpm and the head range from 12 - 470 feet.
- The motor ratings are from 1 to 300 HP.
- Pumps are long coupled with TEFC squirrel cage induction motor with main dimensions complying to NEMA standards MG 1-2006.
- Pumps are available with gland packing as well as mechanical shaft seal.
- Pumps and motors are available with fabricated steel base frame according to EN 23661.
- Pump impellers are dynamically balanced to grade 6.3 of ISO 1940.
- These pumps are available with high efficiency motors complying to meet or exceed the efficiency requirements of the US Energy Policy Act of 1992 (EPAct) and Natural Resources Canada Standards (NRCan).
- The efficiency will meet or exceed full load efficiency of TEFC motors as per Table 12-11 of NEMA standards MG 1-2006.
- They can also be supplied with NEMA premium efficiency TEFC motors as per Table 12-12 of NEMA standards MG 1-2006 on request.
- Pumps has the back pull-out design. This feature helps the user; to remove the motor, bearing bracket & impeller for servicing without disturbing the volute casing and the suction & delivery pipes (see below figure).
- We can also supply pumps with IEC standard motors.

Special features on request

Frequency 50 Hz (as per 50 Hz data sheet).

Caractéristiques saillantes

Les dispositifs de pompes comprenant certaines saillantes sont énumérés ci-dessous :

- Ces pompes sont des pompes d'amorçage de non-individu, horizontal, pompes en une seule étape et centrifuges d'enveloppe de volute avec l'aspiration axiale et le port radial de décharge.
- L'exécution des pompes se conforme avec l' ISO 2858.
- Bride standard à des fins d'aspiration et de refoulement sont ANSI 125 et ANSI 250 selon ASME B16.1. DIN EN 1092-2 avec PN 16 votes et DIN EN 1092-2 avec PN 25 votes peuvent également être offerts sur demande.
- Les pompes a la gamme de décharge de 35 - 3350 USgpm et la gamme principale de 12 - 470 ft.
- Les estimations du moteur sont de 1 à 300 HP.
- Ces pompes sont des pompes couplées avec le moteur à induction de camp d'écureuil de TEFC avec des dimensions principales se conformant aux normes du NEMA MG 1-2006.
- Ces pompes sont disponibles avec l'emballage de glande aussi bien que le joint mécanique d'axe.
- Ces pompes et moteurs sont disponibles avec le bâti en acier fabriqué selon EN 23661.
- Des roues à aubes de pompe sont dynamiquement équilibrées de catégorie 6.3 d'ISO 1940.
- Ces pompes sont disponibles avec la haute efficacité moteurs conformes à égaliser ou dépasser les exigences d'efficacité de la US Energy Policy Act de 1992 (EPAct) et les normes de Ressources naturelles de Canada (RNCAN).
- L'efficacité va atteindre ou dépasser l'efficacité à pleine charge de moteurs TEFC selon le tableau 12-11 de normes NEMA MG 1-2006.
- Ils peuvent également être fournis avec la efficacité prime NEMA de moteurs TEFC selon le tableau 12-12 de normes NEMA MG 1-2006 sur demande.
- Les pompes a la conception d'arrière coulisse. Ce dispositif aide l'utilisateur ; pour enlever le moteur, support de roulement ; roue à aubes pour l'entretien sans toucher à l'enveloppe de volute et d'aspiration ; pipes de la livraison (voir la figure ci-dessous).
- Nous pouvons également fournir des pompes avec des moteurs standards IEC.

Usages spéciaux sur demande

Fréquence 50 hertz (selon la fiche technique 50 d'hertz).

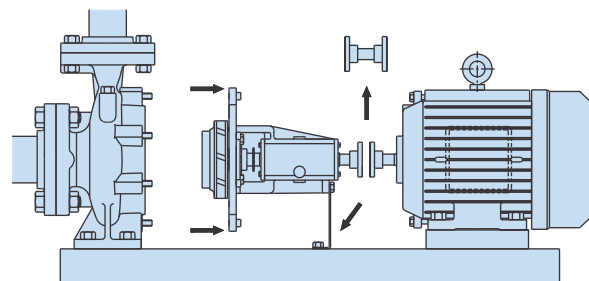

Bomba GBS de nuevo diseño extraíble
GBS pump back pull-out design
Conception à coulisse de dos de pompe de GBS

Características estructurales

Voluta

La voluta de las bombas está diseñada para ser de construcción robusta, soportando presiones ofrecidas por las tuberías. Tienen una toma de aspiración axial y un toma de descarga radial. Las normas de bridas de aspiración y descarga, son ANSI 125 y ANSI 250, según ASME B16.1 DIN 1092-2 PN16. Y DIN EN 1092-2 PN25. Se pueden ofrecer bajo petición otro tipo. La voluta viene con orificios de cebado y drenaje cerrados con tapones.

Adaptador del motor & cubierta posterior

Los adaptadores del motor son de construcción robusta y vienen provistos de un tornillo de ventilación en la cámara del sello del eje.

Soporte del cojinete y del eje

El soporte del cojinete tiene 2 rodamientos antifricción calculados y lubricados de por vida. El soporte del cojinete está hecho de hierro fundido de alta resistencia. El eje está disponible en acero al carbono, así como en acero inoxidable. Una camisa de acero inoxidable va alojada en el eje para protegerlo contra el desgaste y la corrosión.

Todas las bombas se suministran con uno de los cuatro ejes, el sello del eje y soportes de cojinete. Ya que eje y los cojinetes son fuertes y de tamaño adecuado, la bomba puede ser conducida por una correa de transmisión o el motor diesel sin ningún problema.

Un protector de agua se incluye en el eje para evitar que el líquido entre en el soporte del cojinete y dañe el cojinete.

Acoplamiento

Todas las bombas se pueden proporcionar con dos tipos de acoplamientos.

- Acoplamiento estándar
- Acoplamiento espaciador

El uso de acoplamiento espaciador es útil ya que las bombas equipadas con ellos pueden ser reparadas sin necesidad de desmontar el motor de la bancada ni de quitar las tuberías de la voluta. El recalibrado de la bomba y del motor tampoco es necesario después de la reparación.

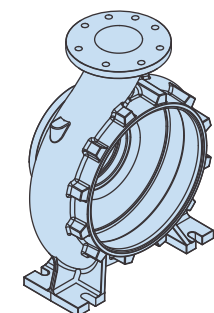

Voluta
Volute casing
Enveloppe de Volute

Constructional features

Volute casing

The volute casing of the pumps are designed to be robust in construction to take the undue stresses offered by the pipe work. They have an axial suction port and radial discharge port. Standard flanges are ANSI 125 and ANSI 250 as per ASME B16.1. PN 16 as per DIN standard EN 1092-2 and PN 25 as per DIN standard EN 1092-2 are available on request. The volute casing are provided with a priming & drain hole closed by plugs.

Motor adaptor & back cover

Motor adaptors are robust in construction and are provided with an air vent screw in the shaft seal chamber.

Shaft & bearing bracket

The bearing bracket is provided with 2 properly sized antifriction ball bearings which are permanently lubricated for life. The bearing bracket is made of cast iron of high tensile strength. The shaft are available in carbon steel as well as stainless steel. A shaft sleeve of stainless steel is provided in the stuffing box to protect the shaft from wear and corrosion.

All pumps are provided with one of four shaft, shaft seal and bearing brackets. As shaft and bearings are strong and properly sized the pump can be driven by a belt drive or diesel engine without any problem.

A water thrower is provided on the shaft to prevent liquid from entering the bearing bracket and damaging the bearing.

Coupling

All pumps can be provided with two types of couplings.

- Standard coupling
- Spacer coupling

The use of spacer coupling is helpful since pumps fitted with them can be serviced without dismantling the motor from the base frame and also without removing the pipe work or volute casing. Realignment of pump and motor is also not necessary after servicing.

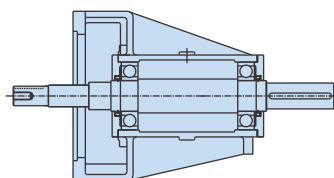

Soporte del cojinete y del eje
Shaft & bearing bracket
Support d'axe et de roulement

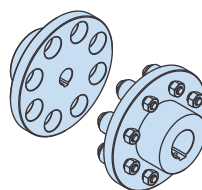

Acoplamiento estándar
Standard coupling
Accouplement standard

Características de construcción

Enveloppe de Volute

L'enveloppe de volute des pompes sont conçues pour être robuste dans la construction pour absorber les efforts anormaux offerts par le travail de pipe. Ils ont un port axial d'aspiration et le port radial de décharge. Brides standard sont ANSI 125 et ANSI 250 selon ASME B16.1. PN 16 selon la norme DIN EN 1092-2 et PN 25 selon la norme DIN EN 1092-2 sont disponibles sur demande. L'enveloppe de volute sont équipées d'amorçage et de trou de drain fermés par des prises.

Adapteur de moteur et arrièrecouverture

Les adapteurs de moteur sont robustes dans la construction et sont équipés de vis d'évent dans la chambre de joint d'axe.

Support d'axe et de roulement

Le support de roulement est équipée de 2 correctement classé roulements à billes antifriction qui sont de manière permanente lubrifiés pour la vie. Le support de roulement est fait de fer de fonte de force à haute résistance. Les axe sont disponible en acier du carbone aussi bien qu'en acier inoxydable. Une douille d'axe d'acier inoxydable est fournie dans la boîte de bourrage pour protéger l'axe contre l'usage et la corrosion.

Toutes les pompes sont équipées d'une de quatre axe, de joint d'axe et de support de roulement. Comme l'axe et les roulements sont forts et sont correctement classés la pompe peut être conduite par une commande par courroie ou un moteur diesel sans aucun problème.

Un lanceur d'eau est fourni sur l'axe pour empêcher le liquide d'entrer dans le support de roulement et d'endommager le roulement.

Accouplement

Toutes les pompes peuvent être équipées de deux types d'accouplements.

- Accouplement standard
- Accouplement d'entretoise

L'utilisation de l'accouplement d'entretoise est utile puisque les pompes équipées avec eux peuvent être entretenues sans démanteler le moteur à partir du bâti et également sans enlever l'enveloppe de travail ou de volute de pipe. Le réalignement de la pompe et du moteur n'est également pas nécessaire après entretien.

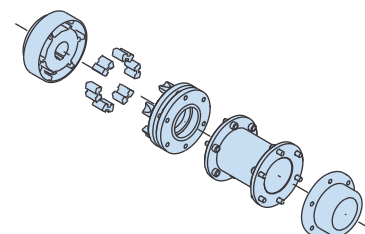

Acoplamiento espaciador
Spacer coupllibg
Accouplement d'entretoise

Características estructurales

Impulsor

Los impulsores son cerrados con un acabado superficial extra suave y completamente mecanizados desde fuera para garantizar una alta eficiencia.

Se encuentran calibrados dinámicamente al grado 6.3 de la norma ISO 1940.

Todos los impulsores pueden ser recortados para adoptar un punto de trabajo solicitado por el cliente.

El recorte diametral del impulsor sugerido como se muestra en las curvas de rendimiento es teórico. El rendimiento puede variar de acuerdo a lo que se muestra en la curva de rendimiento.

Bancada

La bomba y el motor están montados en un bancada de acero común según la norma EN 23661

Constructional features

Impeller

The impellers are closed impellers with extra smooth surface finish and machined completely from outside to ensure high efficiency.

They are dynamically balanced to grade 6.3 of ISO 1940.

All impellers can be trimmed to adopt them for the duty point requested by the customer.

Suggested trimmed impeller diameter as shown on the performance curves are theoretical. Performance may vary from what is shown on the performance curve.

Base frame

Pump and motor are mounted on a common steel base frame in accordance with EN 23661.

Caracteristiques de construction

Roue à aubes

Les roues à aubes sont des roues à aubes fermés avec la finition extérieure sans heurt supplémentaire et usinés complètement de l'extérieur pour assurer le rendement élevé.

Ils sont dynamiquement équilibrés à la catégorie 6.3 d'ISO 1940.

Toutes les roues à aubes peuvent être équilibrées pour adopter le point de devoir demandé par le client.

Le diamètre équilibré suggéré de roue à aubes comme montré sur les courbes d'exécution sont théoriques. L'exécution peut varier de ce qui est montré sur la courbe d'exécution.

Base d'armature

La pompe et le moteur sont montés sur un bâti en acier commun selon EN 23661.

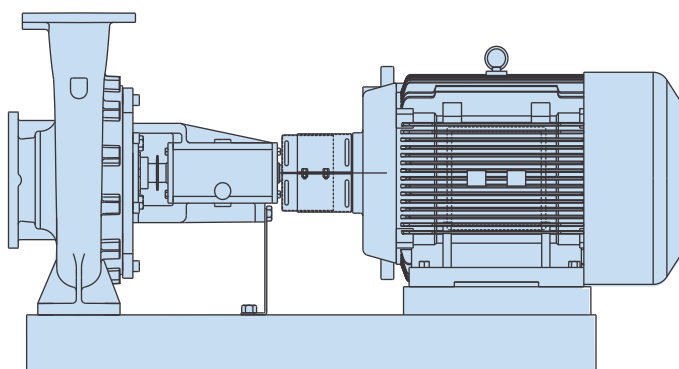

La unidad del motor de la bomba GBS esta montada en un bancada
GBS pump motor unit mounted on a base frame
L'unité de moteur de pompe GBS montée sur un bâti

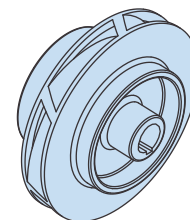

Impulsor
Impeller
Roue à aubes

Presión de prueba

Todas las bombas son probadas hidrostáticamente de fugas de acuerdo a la presión de prueba después de usar agua que contenga inhibidor de corrosión a temperatura ambiente.

Test pressure

All pumps are hydrostatic tested for leakage as per the following test pressure using water containing corrosion inhibitor at room temperature.

Essai de pression

Toutes les pompes sont hydrostatiques examinées pour la fuite selon l'essai de pression suivante en utilisant l'inhibiteur de corrosion contenant de l'eau à la température ambiante.

Grado de la presión Pressure rating Estimation de pression	Presión de funcionamiento Operating pressure Fonctionnement de pression	Presión de prueba Test pressure Essai de pression
ANSI 125	125 psi	188 psi
ANSI 250	250 psi	375 psi
PN 16	16 bar	24 bar
PN 25	25 bar	37,5 bar

Condicion de funcionamiento

Ubicación de la bomba

Las bombas han sido diseñadas para rendir en una atmósfera no explosiva y no agresiva. La humedad relativa no debe superar el 95%.

Niveles de sonido / ruido

Como se muestra en la tabla de abajo, los niveles del ruido del motor no superarán el máximo nivel de presión de sonido [dB (A)] según la siguiente tabla.

Temperatura ambiente y altitud

La temperatura ambiente adecuada para un funcionamiento adecuado del motor no debe superar.

- 104°F para motores de alta eficiencia.
- 140°F para motores de eficiencia premium.

En caso de temperatura ambiente superior a 104°F (o 140°F para eficiencia premium.) o si el motor se va a instalar a más de 3280 Pies sobre el nivel del mar, debe seleccionarse un motor de mayor potencia debido al efecto de bajo enfriamiento. Por favor, consulte el gráfico como se muestra en la siguiente figura para la selección de motor a mayor temperatura o altitud.

Ejemplo

Los motores de 20 HP tienen que ser aumentados en producción a 25 HP si la temperatura ambiente es 140 ° F.

Los motores de 20 HP tienen que ser aumentados en producción a 25 HP si tienen que rendir a 11483 Pies sobre el nivel del mar.

Niveles de sonido/ruido Sound/Noise levels Niveaux de sons/bruit

P2 HP	Máximo nivel de presión sonora [dB (A)] Maximum sound pressure level [db(A)] Niveau de pression acoustique maximum [DB (A)]		
	Motores trifásicos	Three phase motors	Moteurs triphasés
	2-polos 2-pole pole 2	4-polos 4-pole pole 4	6-polos 6-pole pole 6
1	-	51	49
1,5	68	51	49
2	68	51	49
3	69	56	55
4	69	56	55
5	69	56	55
7,5	69	58	57
10	72	58	57
15	72	69	59
20	75	69	59
25	75	68	62
30	75	68	62
40	81	71	65
50	81	71	65
60	85	75	65
75	85	75	65
100	84	75	70
125	84	79	70
150	84	79	73
200	87	82	73

Operating conditions

Pump location

The pumps have been designed to operate in non aggressive and non explosive atmosphere. The relative humidity should not exceed 95%.

Sound/Noise levels

As shown in the table below the motor noise levels will not exceed the maximum sound pressure level [db(A)] as per following table.

Ambient temperature and altitude

The ambient temperature for proper motor operation must not exceed.

- + 104°F for high efficiency motors
- + 140°F for premium efficiency motors.

In case of ambient temperature exceeding 104°F (or 140°F for premium eff.) or if motor is to be installed more than 3280 feet above sea level then a higher output motor should be selected due to low cooling effect. Please refer the chart as shown in below fig. for selection of the motors at higher temperature or altitude.

Example

A 20 HP motors has to be increased in output to 25 HP if ambient temperature is 140°F.

A 20 HP motors has to be increased in output to 25 HP if it has to operate at 11483 feet above mean sea level.

Conditions de fonctionnement

Location de la pompe

Les pompes ont été conçues pour fonctionner en atmosphère non agressive et non explosive. L'hygrométrie ne devrait pas dépasser 95%.

Niveaux de sons /bruit

Suivant les indications de la table au-dessous du moteur les niveaux de bruit ne dépasseront pas le niveau de pression acoustique maximum [DB (A)] selon tableau ci-dessous.

Température ambiante et altitude

La température ambiante pour l'opération appropriée de moteur ne doit pas dépasser.

- + 104 ° F pour les moteurs à haute efficacité
- + 140 ° F pour les moteurs à rendement supérieur.

En cas de température ambiante dépassant 104 ° F (ou 140 ° F pour une efficacité prime.) ou si le moteur doit être installé plus de 3280 Pieds au-dessus du niveau de la mer alors un plus haut moteur de rendement devrait être choisi au bas effet de refroidissement. Veuillez se référer le diagramme suivant les indications au-dessous de la figure. pour le choix des moteurs à la température ou à une altitude plus élevée.

Exemple

Les moteurs de 20 HP doit être grimpés dans le rendement jusqu'à 25 HP si la température ambiante est 140°F.

Des moteurs de 20 HP doit être grimpés dans le rendement jusqu'à 25 HP s'il doit fonctionner à 11483 Pieds de niveau au-dessus de la mer moyen ci-dessus.

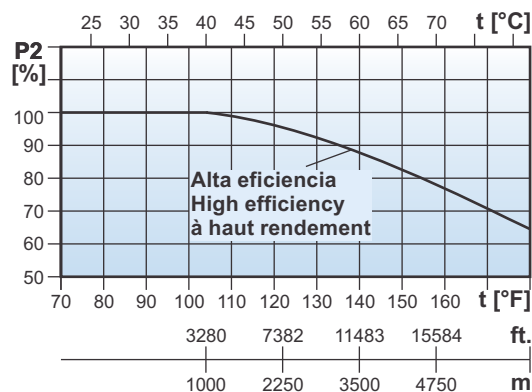

El motor P2 depende de la temperatura / la altitud
Motor P2 depend on temperature/altitude
Le moteur P2 dépend de la température/d'altitude

Condiciónes de funcionamiento

Bombeado de líquidos

Las bombas del GBS están diseñadas para líquidos no explosivos que sean limpios y finos sin partículas sólidas.

Para líquidos agresivos, asegúrese de que el material de construcción sea adecuado para el líquido a ser bombeado.

Un líquido viscoso puede afectar al rendimiento de la bomba de las siguientes maneras.

- El consumo eléctrico de la bomba puede aumentar con el aumento de la viscosidad. Esto requiere un motor más grande para la bomba.
- La eficiencia del cabezal, de descarga & de la bomba se verá reducida.

Un líquido con una densidad alta también afectará al rendimiento de la siguiente manera.

- El consumo de energía aumentará en proporción correspondiente al aumento de la densidad. Por ejemplo un líquido con una gravedad específica de 1,30 requerirá un motor un 30% más grande para conducir la bomba.
- La eficiencia del cabezal, de descarga & de la bomba no va a variar con el cambio de densidad.

Temperatura del líquido

La gama de bombas GBS cubre un rango de temperatura de +32 ° F a +284 ° F.

La temperatura del líquido admisible depende del tipo de sello mecánico provisto en la bomba.

Por favor, consulte la tabla que muestra la relación entre el sello mecánico y la temperatura.

La máxima temperatura de líquido está grabada en la placa de identificación de la bomba.

Operating conditions

Pumped liquids

GBS pumps are designed for non explosive liquids which are clean and thin without any solid particles.

For aggressive liquid please ensure that material of construction is suitable for liquid to be pumped.

A viscous liquid affects the pump performance in the following ways.

- The power consumption of the pump will increase with increase in viscosity. This will require a larger motor for the pump.
- Head, discharge & pump efficiency will reduce.

A liquid with high density will also affect the performance as follows.

- The power consumption will increase at a ratio corresponding to increase in density. For example a liquid with a specific gravity of 1,30 will require 30% larger motor to drive the pump.
- The head, discharge and pump efficiency will not change with change in density.

Liquid temperature

The GBS pump range covers the temperature range from +32°F to +284°F.

The permissible liquid temperature depends on the type of mechanical shaft seal furnished on the pump.

Please refer the table showing relationship between mechanical shaft seal and temperature.

The max. liquid temperature is stamped on the nameplate of the pump.

Conditions de fonctionnement

Liquides pompés

Les pompes de GBS sont conçues pour les liquides non explosifs qui sont propres et minces sans aucune particule pleine.

Pour le liquide agressif assurez-vous s'il vous plait que le matériel de la construction convient au liquide pour être pompé.

Un liquide visqueux affecte l'exécution de pompe des manières suivantes :

- La puissance de la pompe augmentera avec l'augmentation de la viscosité. Ceci exigera un plus grand moteur pour la pompe.
- Dirigez, déchargez et l'efficacité de pompe diminuera.

Un liquide avec une densité affectera également l'exécution comme suit.

- La puissance augmentera à un rapport correspondant à l'augmentation de la densité. Par exemple un liquide avec une densité de 1.30 exigera d'un plus grand moteur de 30% pour conduire la pompe.
- La tête, la décharge et l'efficacité de pompe ne changera pas avec le changement de la densité.

Température liquide

La gamme de pompe de GBS couvre la température ambiante de 32°F à +284°F.

La température liquide permise dépend du type de joint mécanique d'axe meublé sur la pompe.

Veuillez référer la table montrant le rapport entre le joint d'axe et la température mécanique.

La température liquide maximale est emboutie sur la plaque signalétique de la pompe.

Relación entre los sellos del eje y la temperatura Relationship between shaft seals and temperature Rapport entre les joints d'axe et la température

Tipo de sello mecánico del eje Mechanical shaft seal type Type de joint d'axemécanique	Código de sello mecánico del eje Mechanical shaft seal code Code mécanique de joint d'axe	Rango de temperatura Temperature range Rangée de température
De acero inoxidable al carbono / cerámica / NBR / AISI 304 Carbon/Ceramic/NBR/Stainless steel AISI 304 Carbone/Ceramique/NBR/ Acier inoxydable AISI 304	1	+32 ° F a +194 ° F +32°F to +194°F +32°F a +194°F
De acero inoxidable AISI 316 de SiC / SiC / Viton Sic/Sic/Viton/Stainless steel AISI 316 Sic/sic/Viton/acier inoxydable AISI 316	2	+32 ° F a +194 ° F +32°F to +194°F +32°F a +194°F
De acero inoxidable AISI 316 al carbono / SiC / Viton Carbon/Sic/Viton/Stainless steel AISI 316 Carbone/sic/Viton/acier inoxydable AISI 316	3	+32 ° F a +284 ° F +32°F to +284°F +32°F a +284°F

Presión de entrada

- La presión de entrada + la presión de cierre (Presión de la bomba contra la válvula cerrada) no debe exceder la presión máxima de funcionamiento de la bomba.
- La presión de entrada mínima debe ser de acuerdo a la curva NPSH + 2 Pies de margen de seguridad + corrección de la presión de vapor.

Inlet pressure

- The inlet pressure + shut off pressure (pressure of pump against closed valve) should not exceed the maximum operating pressure of the pump.
- The minimum inlet pressure must be according to the NPSH curve + 2 feet safety margin + correction of vapour pressure.

Pression d'admission

- La presión d'admission + a coupé la presión (la presión de pompe contre la valve fermée) ne devrait pas dépasser la pression maximum d'operation de la pompe.
- La pression d'admission minimum doit être selon la courbe de NPSH + 2 Pieds marge de sûreté + correction de pression de vapeur.

Datos del producto Product Data Données de produit

Designación / Designation / Désignation

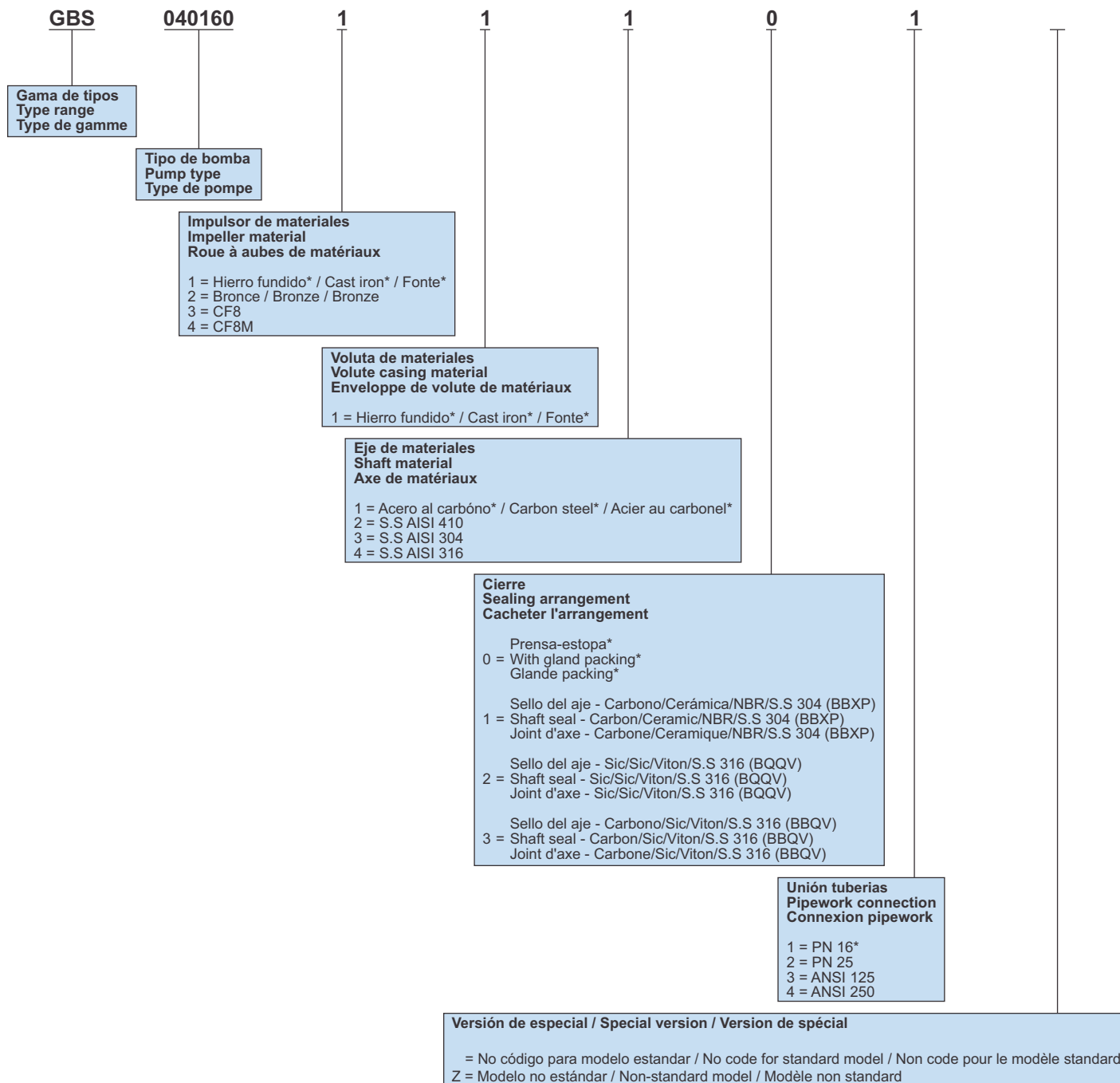

Nota: * Construcción estándar.

Note: * Standard construction.

Note: * Construction standard.

Ejemplo / Example / Exemple

Designación Designation Désignation	Código de pedido Order code Code d'ordre
Bomba GBS 40-160, Hierro fundido impulso, Hierro fundido voluta, Acero al carbón eje, Prensa-estopa, PN 16 unión GBS 40-160 pump, Cast iron impeller, Cast iron volute casing, Carbon steel shaft, With gland packing, PN 16 connection Pompe de GBS 40-160, Fonte roue à aubes, Fonte enveloppe de volute, Acier au charbonel axe, Glande packing, PN 16 Connexion	GBS04016011101



Datos del producto Product Data Données de produit

Material Materials Matériaux

Pos.*	Componente Component Composant	Material Material Matériel
1	Voluta Volute casing Enveloppe de Volute	Hierro fundido Cast iron Fonte
2	Impulsor Impeller Roue à aubes	Hierro fundido Cast iron Fonte
3	Contra cubierta Back cover Arrièrecouverture	Hierro fundido Cast iron Fonte
4	Anillo de desgaste** Wear ring** Anneau d'usage**	Hierro fundido Cast iron Fonte
5	Eje de la bomba Pump shaft Axe de pompe	Acero al carbón Carbon steel Acier au carbonel
6	Camisa Shaft sleeve Douille d'axe	S.S AISI 410
7	Arandela de impulsor Impeller washer Rondelle de roue à aubes	S.S AISI 410
8	Cierre de impulsor Impeller lock pin Goupille de serrure de roue à aubes	S.S AISI 410
9	Chaveta del impulsor Impeller key Clef de roue à aubes	S.S AISI 410
10	Tapon Plugs Prises	Acero al carbón Carbon steel Acier au carbonel
11	Junta tórica O-ring Joint circulaire	NBR
12	Soporte de cojinete Bearing bracket Support de roulement	Hierro fundido Cast iron Fonte
13	Pie Foot Pied	Acero al carbón Carbon steel Acier au carbonel
14	Cubierta de cojinete Bearing cover Rapport de la couverture	Hierro fundido Cast iron Fonte
15	Protector de agua Water thrower Lanceur de l'eau	NBR
16	Espaciador Spacer Entretoise	S.S AISI 410
17	Portas-prensas Gland follower Disciple de glande	Hierro fundido Cast iron Fonte

Nota: * Para partes posición ver el dibujo seccional en contiguo con página.

** Anillo de desgaste disponible sólo por encargo.

Note: * For parts position see sectional drawing in following page.

** Wear ring is available on request only.

Note: * Pour les parties la position voir le dessin à éléments dans contiguo à la page.

** L'anneau d'usage est disponible sur demande seulement.

Dibujo seccional
Sectional drawing
Schéma sectionnel

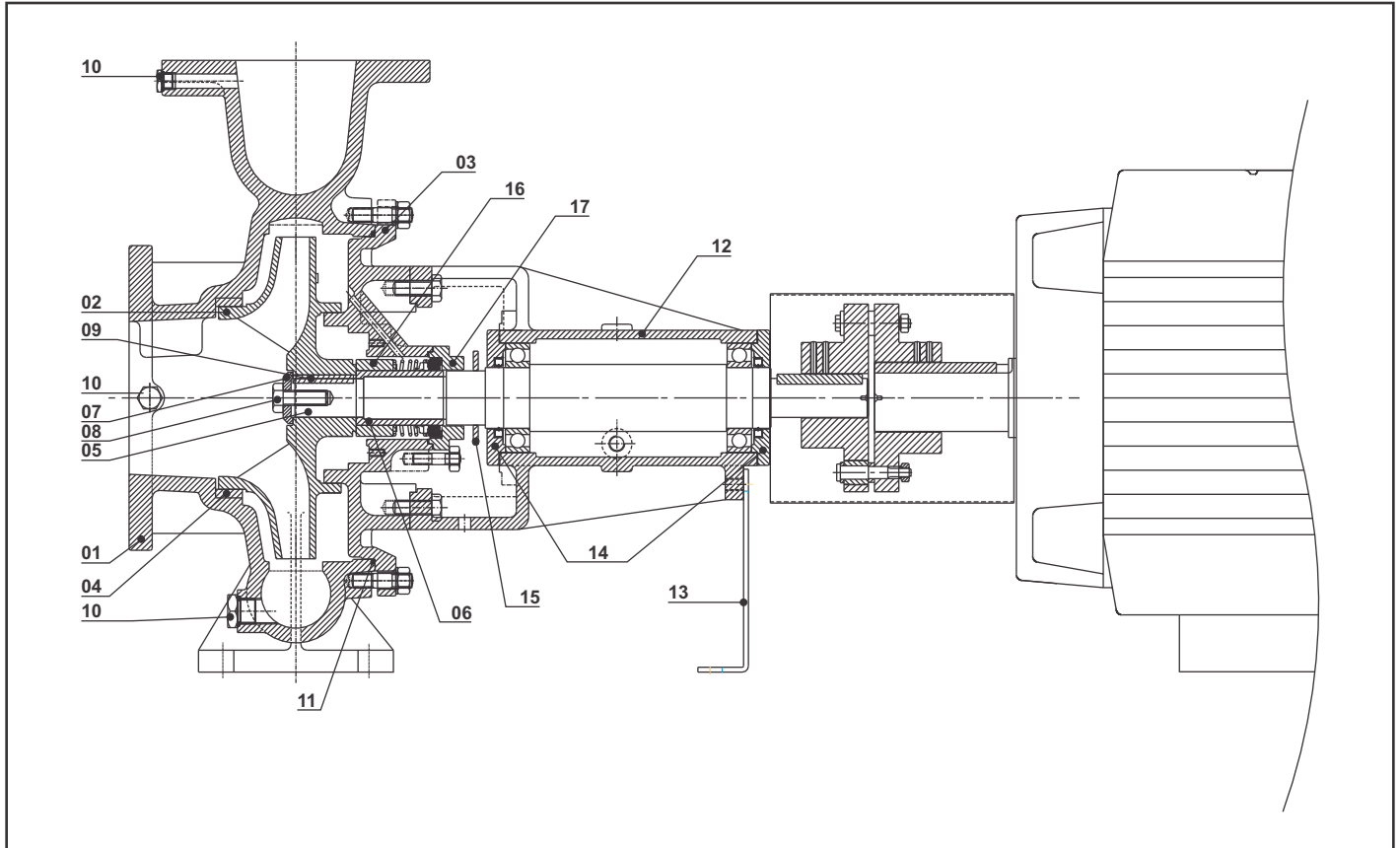

Motor Dimensions

Motor Dimensions

Motor Dimensions

T y TS carcasa
T and TS frame
T et TS vue

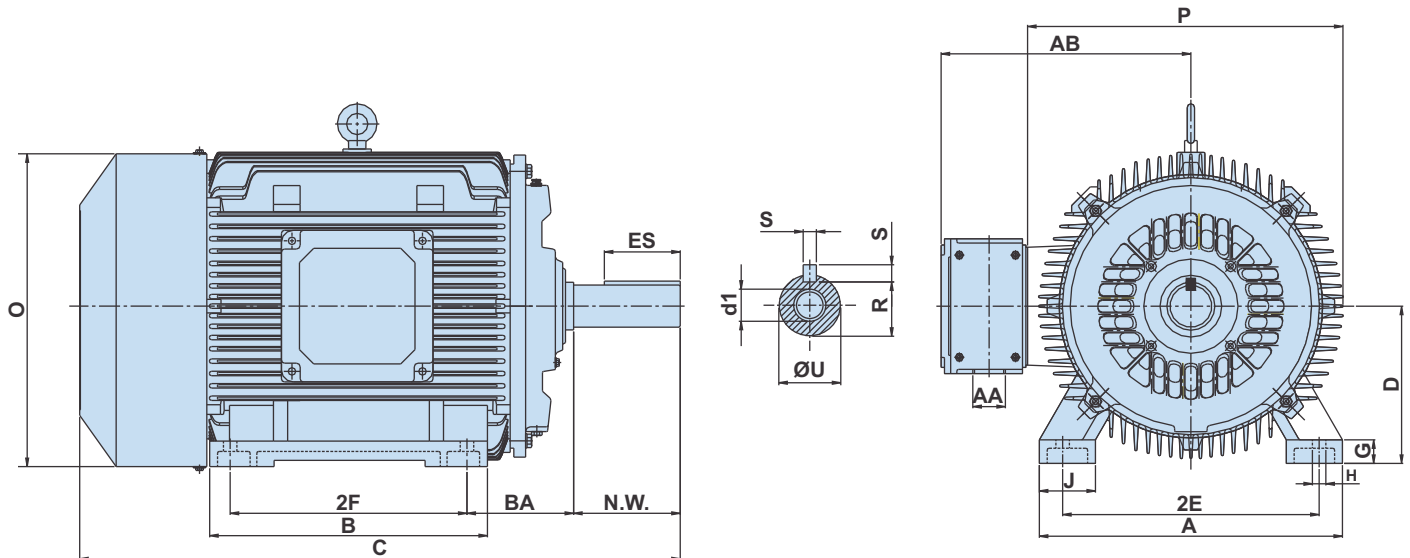

Tamaño de Carcasa Frame size Taille de vue	2E	2F	H	BA	A	B	D	G	J	O	P	AB	AA	N.W.	U	S	R	ES	C
143T	5,5	4,0	0,34	2,25	6,88	6,3	3,5	0,51	1,50	6,97	7,17	5,70	3/4"	2,250	0,875	0,187	0,771	1,410	13,38
145T	5,5	5,0	0,34	2,25	6,88	6,3	3,5	0,51	1,50	6,97	7,17	5,70	3/4"	2,250	0,875	0,187	0,771	1,410	13,38
182T	7,5	4,5	0,406	2,75	9,05	7,08	4,5	0,59	1,65	8,78	8,70	6,46	3/4"	2,750	1,125	0,250	0,986	1,780	16,06
184T	7,5	5,5	0,406	2,75	9,05	7,08	4,5	0,59	1,65	8,78	8,70	6,46	3/4"	2,750	1,125	0,250	0,986	1,780	16,06
213T	8,5	5,5	0,41	3,50	10,1	8,66	5,25	0,70	2,55	10,35	10,31	7,40	1"	3,375	1,375	0,313	1,201	2,410	19,80
215T	8,5	7,0	0,41	3,50	10,1	8,66	5,25	0,70	2,55	10,35	10,31	7,40	1"	3,375	1,375	0,313	1,201	2,410	19,80
254T	10,0	8,25	0,53	4,25	12,2	10,24	6,25	0,70	2,16	12,28	12,16	9,49	1-1/4"	4,000	1,625	0,375	1,416	2,910	23,19
256T	10,0	10,0	0,53	4,25	12,2	11,81	6,25	0,70	2,16	12,28	12,16	9,49	1-1/4"	4,000	1,625	0,375	1,416	2,910	24,84
284T	11,0	9,5	0,53	4,76	13,47	12,20	7,00	1,06	2,60	14,09	14,09	11,57	1-1/2"	4,622	1,875	0,500	1,591	3,280	28,30
284TS	11,0	9,5	0,53	4,76	13,47	12,20	7,00	1,06	2,60	14,09	14,09	11,57	1-1/2"	3,250	1,625	0,375	1,416	1,910	26,97
286T	11,0	11,0	0,53	4,76	13,47	13,39	7,00	1,06	2,60	14,09	14,09	11,57	1-1/2"	4,622	1,875	0,500	1,591	3,280	29,84
286TS	11,0	11,0	0,53	4,76	13,47	13,39	7,00	1,06	2,60	14,09	14,09	11,57	1-1/2"	3,250	1,625	0,375	1,416	1,910	28,46
324T	12,5	10,5	0,66	5,25	15,75	15,35	8,00	1,18	3,39	15,62	15,24	12,05	2"	5,250	2,125	0,500	1,845	3,910	32,32
324TS	12,5	10,5	0,66	5,25	15,75	15,35	8,00	1,18	3,39	15,62	15,24	12,05	2"	3,750	1,875	0,500	1,591	2,030	30,82
326T	12,5	12,0	0,66	5,25	15,75	15,35	8,00	1,18	3,39	15,62	15,24	12,05	2"	5,250	2,125	0,500	1,845	3,910	32,32
326TS	12,5	12,0	0,66	5,25	15,75	15,35	8,00	1,18	3,39	15,62	15,24	12,05	2"	3,750	1,875	0,500	1,591	2,030	30,82
364T	14,0	11,25	0,66	5,86	17,72	14,57	9,00	1,26	3,35	17,28	17,00	12,91	3"	5,874	2,375	0,625	2,021	4,280	33,42
364TS	14,0	11,25	0,66	5,86	17,72	14,57	9,00	1,26	3,35	17,28	17,00	12,91	3"	3,748	1,875	0,500	1,591	2,030	31,30
365T	14,0	12,25	0,66	5,86	17,72	15,55	9,00	1,26	3,35	17,28	17,00	12,91	3"	5,874	2,375	0,625	2,021	4,280	34,40
365TS	14,0	12,25	0,66	5,86	17,72	15,55	9,00	1,26	3,35	17,28	17,00	12,91	3"	3,748	1,875	0,500	1,591	2,030	32,28
404T	15,98	12,25	0,807	6,625	20,0	16,73	10,00	1,65	3,93	19,6	19,76	16,30	3"	7,250	2,875	0,750	2,449	5,512	38,46
405T	15,98	13,74	0,807	6,625	20,0	16,73	10,00	1,65	3,93	19,6	19,76	16,30	3"	7,250	2,875	0,750	2,449	5,512	38,46
405TS	15,98	13,74	0,807	6,625	20,0	16,73	10,00	1,65	3,93	19,6	19,76	16,30	3"	4,250	2,125	0,500	1,842	2,756	35,47
444T	18,0	14,5	0,807	7,50	21,26	19,29	11,00	1,65	3,93	21,85	22,12	17,50	3"	8,500	3,375	0,875	2,880	7,087	42,79
444TS	18,0	14,5	0,807	7,50	21,26	19,29	11,00	1,65	3,93	21,85	22,12	17,50	3"	4,750	2,375	0,625	2,021	3,000	39,05
445T	18,0	16,5	0,807	7,50	21,26	19,29	11,00	1,65	3,93	21,85	22,12	17,50	3"	8,500	3,375	0,875	2,880	7,087	42,77
445TS	18,0	16,5	0,807	7,50	21,26	19,29	11,00	1,65	3,93	21,85	22,12	17,50	3"	4,750	2,375	0,625	2,021	3,000	39,05
505T	20,0	18,0	1,25	8,50	24,4	20,98	12,50	1,81	4,40	24,21	23,62	19,37	3"	10,630	3,625	0,875	3,134	8,661	49,45
505TS	20,0	18,0	1,25	8,50	24,4	20,98	12,50	1,81	4,40	24,21	23,62	19,37	3"	4,750	2,375	0,625	2,021	3,000	43,57
587T	23,0	25,0	1,18	10,0	29,5	29,92	14,50	2,48	5,12	29,06	32,12	26,77	3"	11,625	3,875	1,000	3,312	8,661	61,07

Nota: Todas las medidas en pulgadas, salvo que se indique lo contrario.

Note: All dimensions in inches unless otherwise noted.

Note: Toutes les dimensions en pouces sauf indication contraire.

Gama de Rendimiento

Performance Range

Gamme de performances

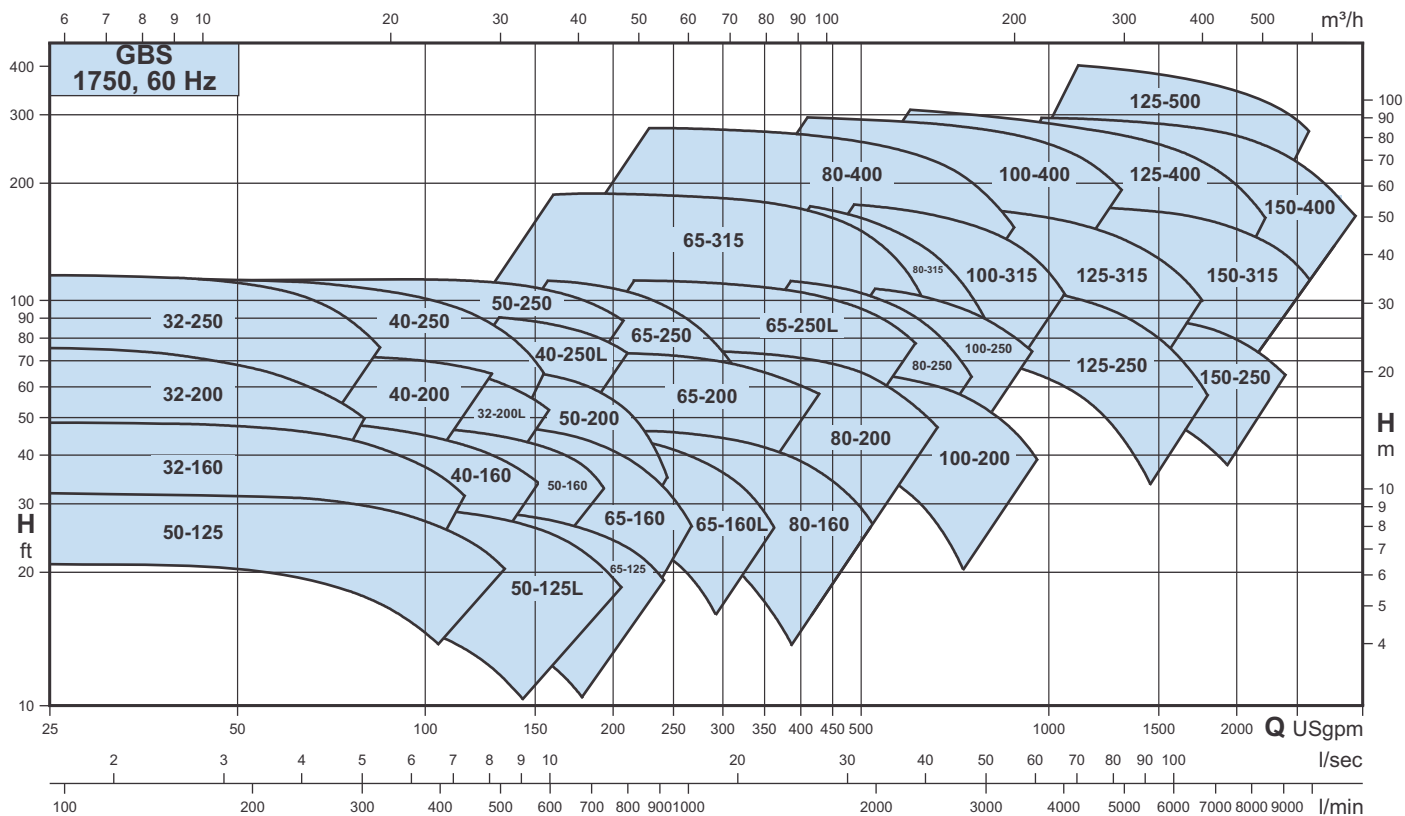
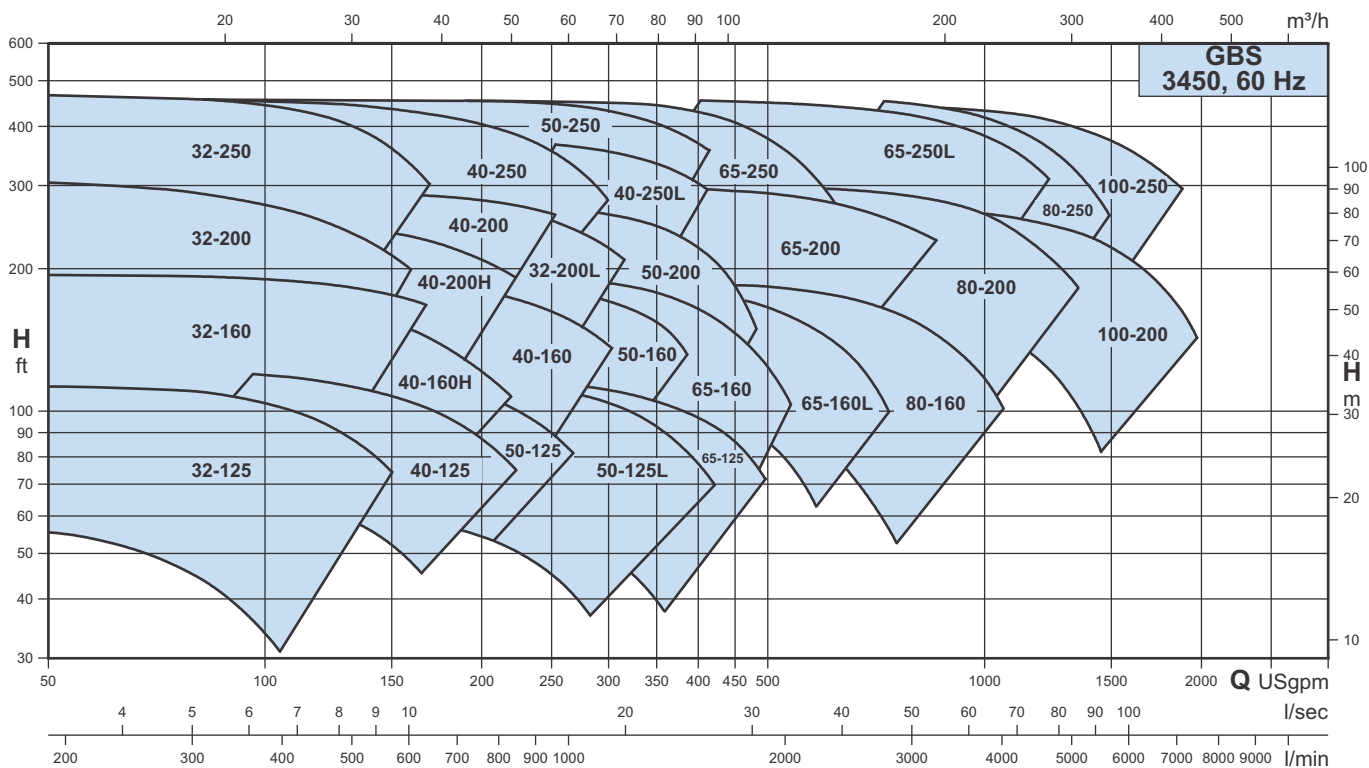

Gama de Rendimiento

Performance Range

Gamme de performances

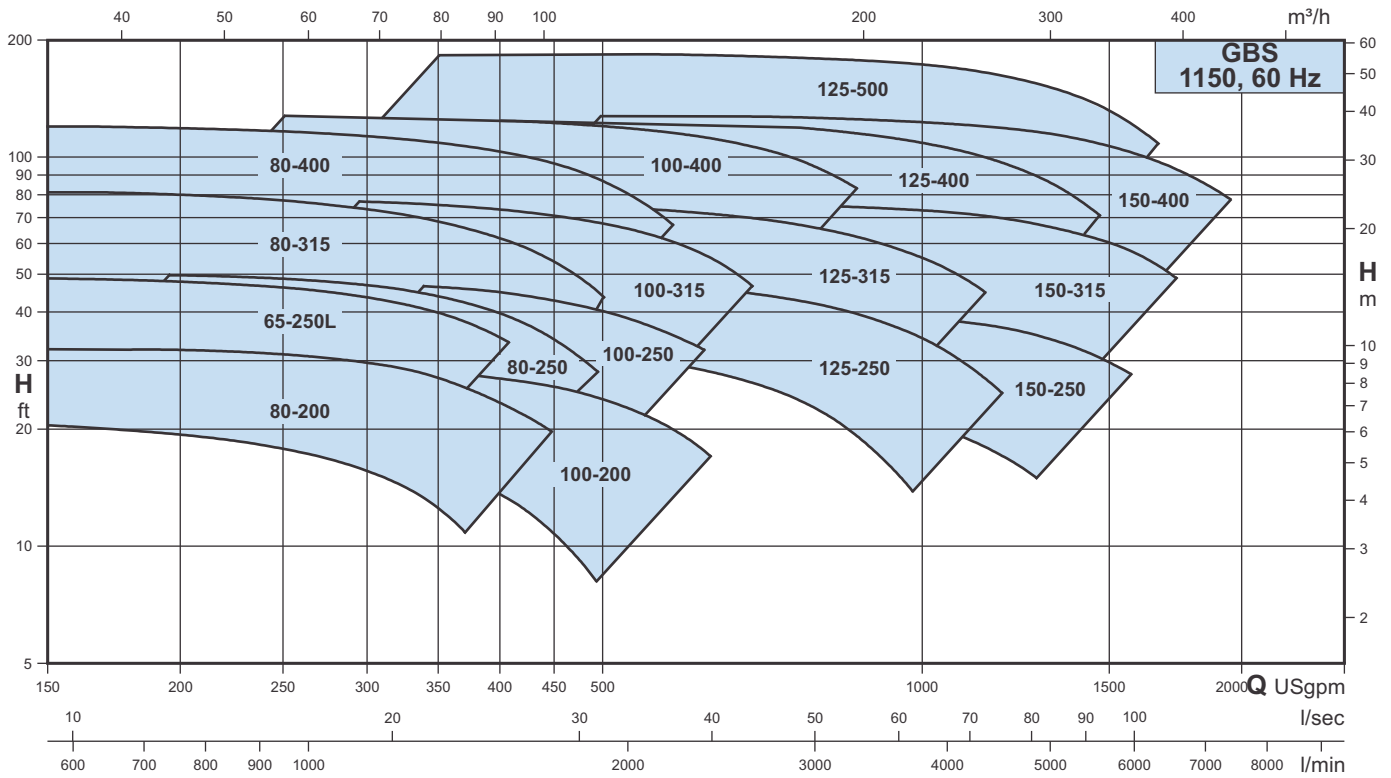

Tipo de bomba Pump type Type de pompe	2-polos 2-pole pole 2	4-polos 4-pole pole 4	6-polos 6-pole pole 6
GBS 32-125	■		
GBS 32-160	■		
GBS 32-200	■	■	
GBS 32-200L	■	■	
GBS 32-250	■	■	
GBS 40-125	■	■	
GBS 40-125L	■	■	
GBS 40-160	■	■	
GBS 40-160H	■	■	
GBS 40-200	■	■	
GBS 40-200H	■	■	
GBS 40-250	■	■	
GBS 40-250L	■	■	
GBS 50-125	■	■	
GBS 50-125L	■	■	
GBS 50-160	■	■	
GBS 50-200	■	■	
GBS 50-250	■	■	
GBS 65-125	■	■	
GBS 65-160	■	■	
GBS 65-160L	■	■	
GBS 65-200	■	■	
GBS 65-250	■	■	
GBS 65-315	■	■	
GBS 80-160	■	■	
GBS 80-200	■	■	
GBS 80-250	■	■	■
GBS 65-250L	■	■	■
GBS 80-315		■	■
GBS 80-400		■	■
GBS 100-200	■	■	■
GBS 100-250	■	■	■
GBS 100-315		■	■
GBS 100-400		■	■
GBS 125-250		■	■
GBS 125-315		■	■
GBS 125-400		■	■
GBS 125-500		■	■
GBS 150-250		■	■
GBS 150-315		■	■
GBS 150-400		■	■
GBS 150-500		■	■

■ Tipo de bomba disponible.

■ Available pump type.

■ Type de pompe disponible.



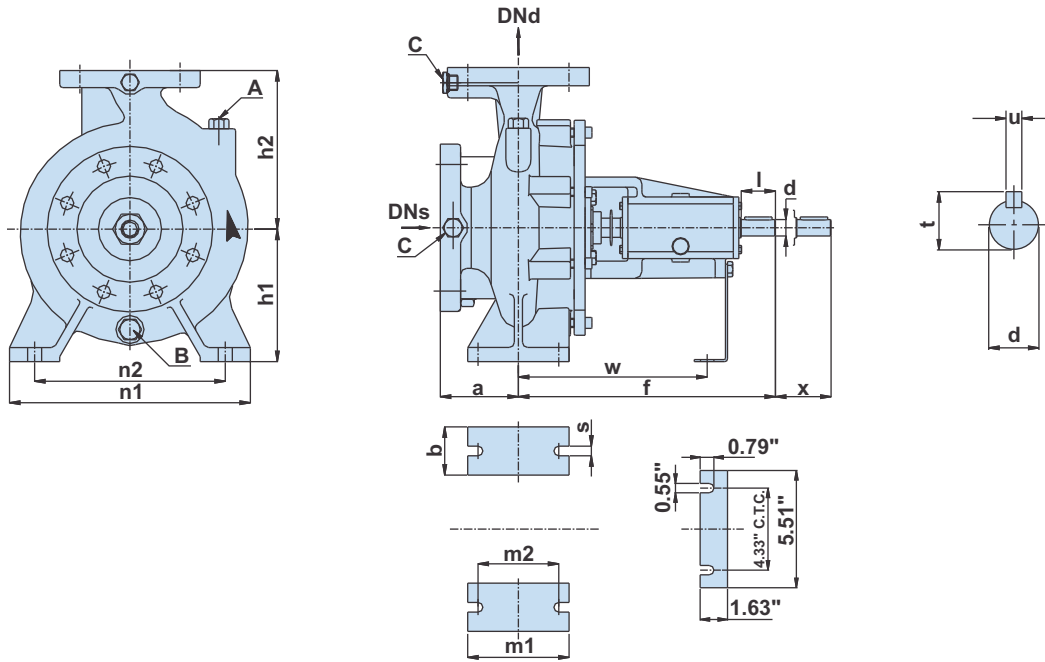

Tipo de bomba Pump type Type de pompe	DNs	DNd	a	b	d.k6	f	h1	h2	l	m1	m2	n1	n2	s	t	u	w	x	A	B	C	Peso neto Net weight Poids net [lbs]	Peso bruto Gross weight Poids brut [lbs]	Volumen Volume Volume [ft³]
GBS 32-125	2	1.25	3.15	1.97	0.94	14.17	4.41	5.51	1.97	3.94	2.76	7.48	5.51	0.55	1.06	0.31	10.24	3.1	Ø3/8	Ø1/2	Ø1/4	62	84	2.96
GBS 32-160	2	1.25	3.15	1.97	0.94	14.17	5.20	6.30	1.97	3.94	2.76	9.45	7.48	0.55	1.06	0.31	10.24	3.5	Ø3/8	Ø1/2	Ø1/4	81	103	2.96
GBS 32-200	2	1.25	3.15	1.97	0.94	14.17	6.30	7.09	1.97	3.94	2.76	9.45	7.48	0.55	1.06	0.31	10.24	3.1	Ø3/8	Ø1/2	Ø1/4	92	114	2.96
GBS 32-200L	2	1.25	3.15	1.97	0.94	14.17	6.30	7.09	1.97	3.94	2.76	9.45	7.48	0.55	1.06	0.31	10.24	3.1	Ø3/8	Ø1/2	Ø1/4	88	110	2.96
GBS 32-250	2	1.25	3.94	2.56	0.94	14.17	7.09	8.86	1.97	4.92	3.74	12.60	9.84	0.55	1.06	0.31	10.24	3.9	Ø3/8	Ø1/2	Ø1/4	103	125	5.00
GBS 40-125	2.5	1.5	3.15	1.97	0.94	14.17	4.41	5.51	1.97	3.94	2.76	8.27	6.30	0.55	1.06	0.31	10.24	3.5	Ø3/8	Ø1/2	Ø1/4	66	88	2.96
GBS 40-125L	2.5	1.5	3.15	1.97	0.94	14.17	4.41	5.51	1.97	3.94	2.76	8.27	6.30	0.55	1.06	0.31	10.24	3.5	Ø3/8	Ø1/2	Ø1/4	66	88	2.96
GBS 40-160	2.5	1.5	3.15	1.97	0.94	14.17	5.20	6.30	1.97	3.94	2.76	9.45	7.48	0.55	1.06	0.31	10.24	3.5	Ø3/8	Ø1/2	Ø1/4	73	95	2.96
GBS 40-160H	2.5	1.5	3.15	1.97	0.94	14.17	5.20	6.30	1.97	3.94	2.76	9.45	7.48	0.55	1.06	0.31	10.24	3.5	Ø3/8	Ø1/2	Ø1/4	73	95	2.96
GBS 40-200	2.5	1.5	3.94	1.97	0.94	14.17	6.30	7.09	1.97	3.94	2.76	10.43	8.35	0.55	1.06	0.31	10.24	3.5	Ø3/8	Ø1/2	Ø1/4	84	106	2.96
GBS 40-200H	2.5	1.5	3.94	1.97	0.94	14.17	6.30	7.09	1.97	3.94	2.76	10.43	8.35	0.55	1.06	0.31	10.24	3.5	Ø3/8	Ø1/2	Ø1/4	84	106	2.96
GBS 40-250	2.5	1.5	3.94	2.56	0.94	14.17	7.09	8.86	1.97	4.92	3.74	12.60	9.84	0.55	1.06	0.31	10.24	4.3	Ø3/8	Ø1/2	Ø1/4	112	134	5.00
GBS 40-250L	2.5	1.5	3.94	2.56	0.94	14.17	7.09	8.86	1.97	4.92	3.74	12.60	9.84	0.55	1.06	0.31	10.24	4.3	Ø3/8	Ø1/2	Ø1/4	112	134	5.00
GBS 50-125	2.5	2	3.94	1.97	0.94	14.17	5.20	6.30	1.97	3.94	2.76	9.45	7.48	0.55	1.06	0.31	10.24	3.5	Ø3/8	Ø1/2	Ø1/4	70	92	2.96
GBS 50-125L	2.5	2	3.94	1.97	0.94	14.17	5.20	6.30	1.97	3.94	2.76	9.45	7.48	0.55	1.06	0.31	10.24	3.5	Ø3/8	Ø1/2	Ø1/4	70	92	2.96
GBS 50-160	2.5	2	3.94	1.97	0.94	14.17	6.30	7.09	1.97	3.94	2.76	10.43	8.35	0.55	1.06	0.31	10.24	3.9	Ø3/8	Ø1/2	Ø1/4	81	103	2.96
GBS 50-200	2.5	2	3.94	1.97	0.94	14.17	6.30	7.87	1.97	3.94	2.76	10.43	8.35	0.55	1.06	0.31	10.24	4.3	Ø3/8	Ø1/2	Ø1/4	90	112	5.00
GBS 50-250	2.5	2	3.94	2.56	0.94	14.17	7.09	8.86	1.97	4.92	3.74	12.60	9.84	0.55	1.06	0.31	10.24	4.7	Ø3/8	Ø1/2	Ø1/4	117	139	5.00
GBS 65-125	3	2.5	3.94	2.56	0.94	14.17	6.30	7.09	1.97	4.92	3.74	11.02	8.35	0.55	1.06	0.31	10.24	3.5	Ø3/8	Ø1/2	Ø1/4	86	108	2.96
GBS 65-160	3	2.5	3.94	2.56	0.94	14.17	6.30	7.87	1.97	4.92	3.74	11.02	8.35	0.55	1.06	0.31	10.24	3.5	Ø3/8	Ø1/2	Ø1/4	99	121	5.00
GBS 65-160L	3	2.5	3.94	2.56	0.94	14.17	6.30	7.87	1.97	4.92	3.74	11.02	8.35	0.55	1.06	0.31	10.24	3.9	Ø3/8	Ø1/2	Ø1/4	99	121	5.00
GBS 65-200	3	2.5	3.94	2.56	0.94	14.17	7.09	8.86	1.97	4.92	3.74	12.60	9.84	0.55	1.06	0.31	10.24	4.3	Ø3/8	Ø1/2	Ø1/4	101	123	5.00
GBS 65-250	3	2.5	3.94	3.15	1.26	18.50	7.87	9.84	3.15	6.30	4.72	14.17	11.02	0.71	1.38	0.39	13.39	4.7	Ø3/8	Ø1/2	Ø1/4	167	189	7.93
GBS 65-315	3	2.5	4.92	3.15	1.26	18.50	8.86	11.02	3.15	6.30	4.72	15.75	12.40	0.71	1.38	0.39	13.39	5.1	Ø3/8	Ø1/2	Ø1/4	207	229	7.93
GBS 80-160	4	3	4.92	2.56	0.94	14.17	7.09	8.86	1.97	4.92	3.74	12.60	9.84	0.55	1.06	0.31	10.24	5.1	Ø3/8	Ø1/2	Ø1/4	114	136	5.00
GBS 80-200	4	3	4.92	2.56	1.26	18.50	7.09	9.84	3.15	4.92	3.74	13.58	11.02	0.55	1.38	0.39	13.39	5.1	Ø3/8	Ø1/2	Ø1/4	150	172	7.93
GBS 80-250	4	3	4.92	3.15	1.26	18.50	7.87	11.02	3.15	6.30	4.72	15.75	12.40	0.71	1.38	0.39	13.39	5.1	Ø3/8	Ø1/2	Ø1/4	180	202	7.93
GBS 65-250L	4	2.5	3.94	3.15	1.26	18.50	7.87	9.84	3.15	6.30	4.72	14.17	11.02	0.71	1.38	0.39	13.39	4.7	Ø3/8	Ø1/2	Ø1/4	167	189	7.93
GBS 80-315	4	3	4.92	3.15	1.26	18.50	9.84	12.40	3.15	6.30	4.72	15.75	12.40	0.71	1.38	0.39	13.39	5.5	Ø3/8	Ø1/2	Ø1/4	209	354	13.74
GBS 80-400	4	3	5.51	3.15	1.65	20.87	11.02	13.98	4.33	6.30	4.72	17.13	13.98	0.71	1.77	0.47	14.57	6.1	Ø3/8	Ø1/2	Ø1/4	319	464	17.27
GBS 100-200	5	4	4.92	3.15	1.26	18.50	7.87	11.02	3.15	6.30	4.72	14.17	11.02	0.71	1.38	0.39	13.39	5.5	Ø3/8	Ø1/2	Ø1/4	174	196	7.93
GBS 100-250	5	4	5.51	3.15	1.26	18.50	8.86	11.02	3.15	6.30	4.72	15.75	12.40	0.71	1.38	0.39	13.39	5.5	Ø3/8	Ø1/2	Ø1/4	198	220	7.93
GBS 100-315	5	4	5.51	3.15	1.26	18.50	9.84	12.40	3.15	6.30	4.72	15.75	12.40	0.71	1.38	0.39	13.39	6.1	Ø3/8	Ø1/2	Ø1/4	229	374	13.74
GBS 100-400	5	4	5.51	3.94	1.65	20.87	11.02	13.98	4.33	7.87	5.91	19.69	15.75	0.87	1.77	0.47	14.57	6.7	Ø3/8	Ø1/2	Ø1/4	319	464	17.27
GBS 125-250	6	5	5.51	3.15	1.26	18.50	9.84	13.98	3.15	6.30	4.72	15.75	12.40	0.71	1.38	0.39	13.39	5.9	Ø3/8	Ø1/2	Ø1/4	257	403	13.74
GBS 125-315	6	5	5.51	3.94	1.65	20.87	11.02	13.98	4.33	7.87	5.91	19.69	15.75	0.87	1.77	0.47	14.57	6.3	Ø3/8	Ø1/2	Ø1/4	312	458	17.27
GBS 125-400	6	5	5.51	3.94	1.65	20.87	12.40	15.75	4.33	7.87	5.91	19.69	15.75	0.87	1.77	0.47	14.57	6.7	Ø3/8	Ø1/2	Ø1/4	392	568	21.96
GBS 125-500	6	5	7.09	4.92	2.36	26.38	15.75	19.69	4.33	7.87	5.91	24.61	19.69	0.87	2.48	0.71	19.69	5.5	Ø3/8	Ø1/2	Ø1/4	587	807	34.47
GBS 150-250	8	6	6.30	3.94	1.65	20.87	11.02	14.76	4.33	7.87	5.91	19.69	15.75	0.87	1.77	0.47	14.57	5.5	Ø3/8	Ø1/2	Ø1/4	312	458	15.47
GBS 150-315	8	6	6.30	3.94	1.65	20.87	11.02	15.75	4.33	7.87	5.91	21.65	17.72	0.87	1.77	0.47	14.57	7.1	Ø3/8	Ø1/2	Ø1/4	367	543	21.96
GBS 150-400	8	6	6.30	3.94	1.65	20.87	12.40	17.72	4.33	7.87	5.91	21.65	17.72	0.87	1.77	0.47	14.57	7.5	Ø3/8	Ø1/2	Ø1/4	440	616	21.96
GBS 150-500	8	6	7.09	4.92	2.36	26.38	15.75	19.69	4.33	7.87	5.91	24.61	19.69	0.87	2.54	0.71	19.69	5.5	Ø3/8	Ø1/2	Ø1/4	671	902	35.28

Nota: Todas las medidas en pulgadas, salvo que se indique lo contrario.

Note: All dimensions in inches unless otherwise noted.

Note: Toutes les dimensions en pouces sauf indication contraire.



GBS 32-125

Curvas Características
Characteristic Curves
Courbes Caractéristiques

3450

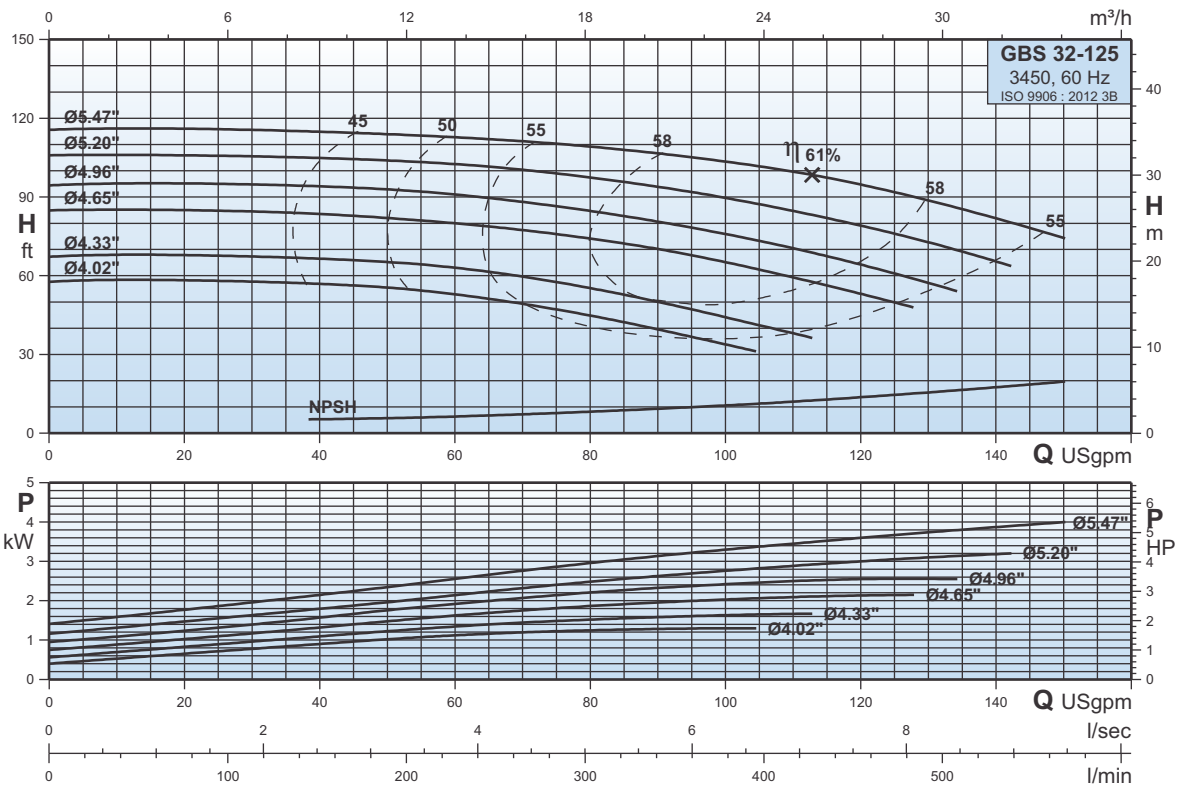

GBS 32-160

Curvas Características
Characteristic Curves
Courbes Caractéristiques

3450

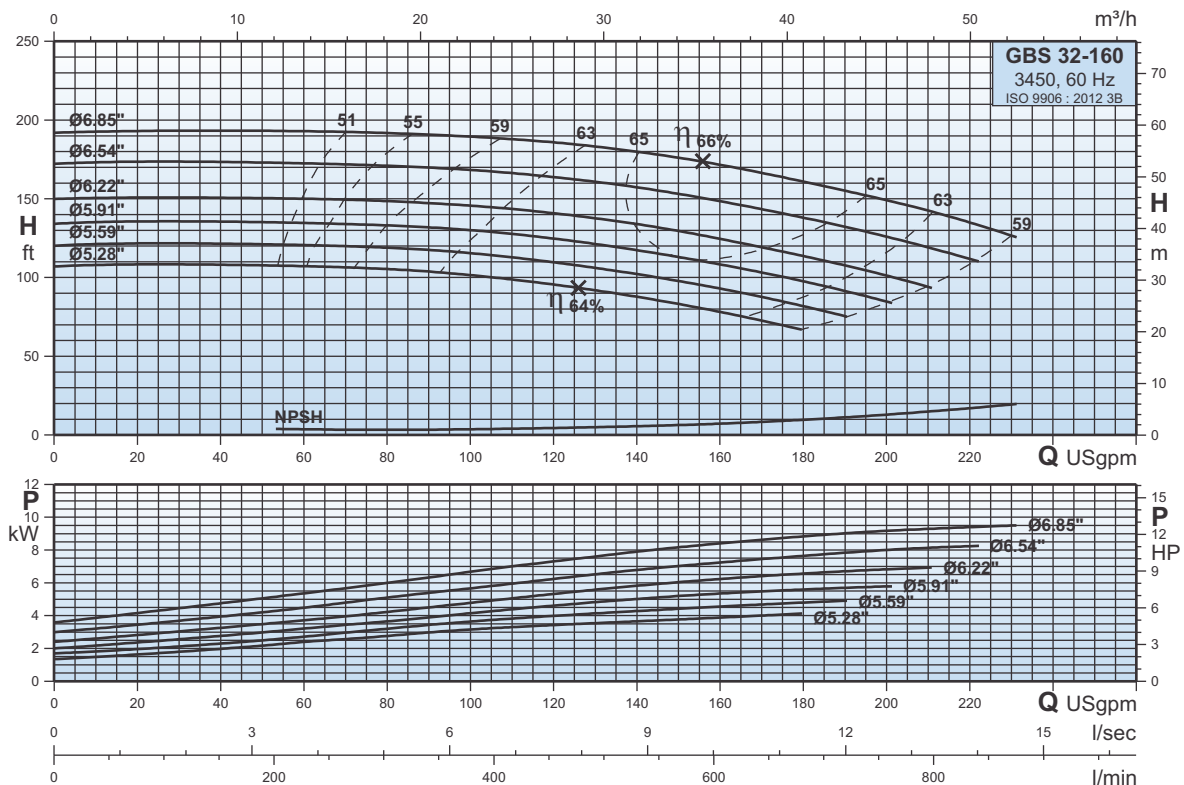

GBS 32-200

Curvas Características
Characteristic Curves
Courbes Caractéristiques

3450

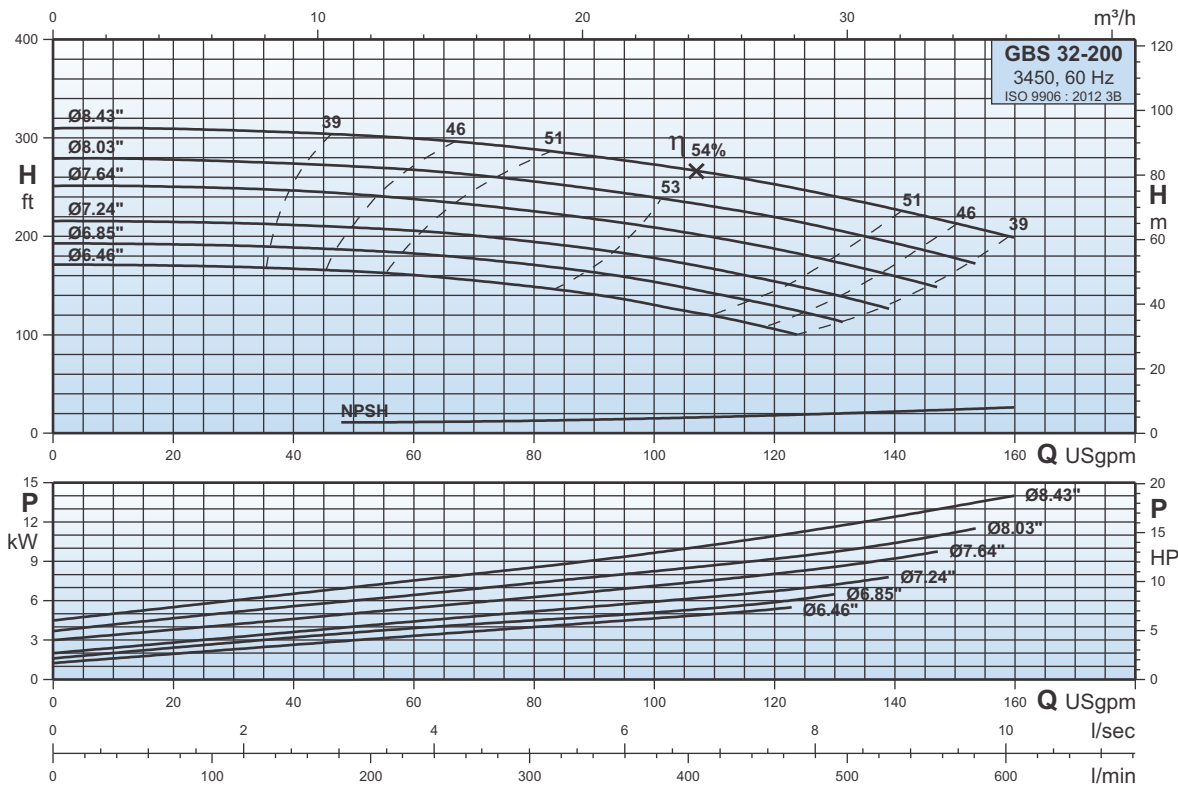

GBS 32-200L

Curvas Características
Characteristic Curves
Courbes Caractéristiques

3450

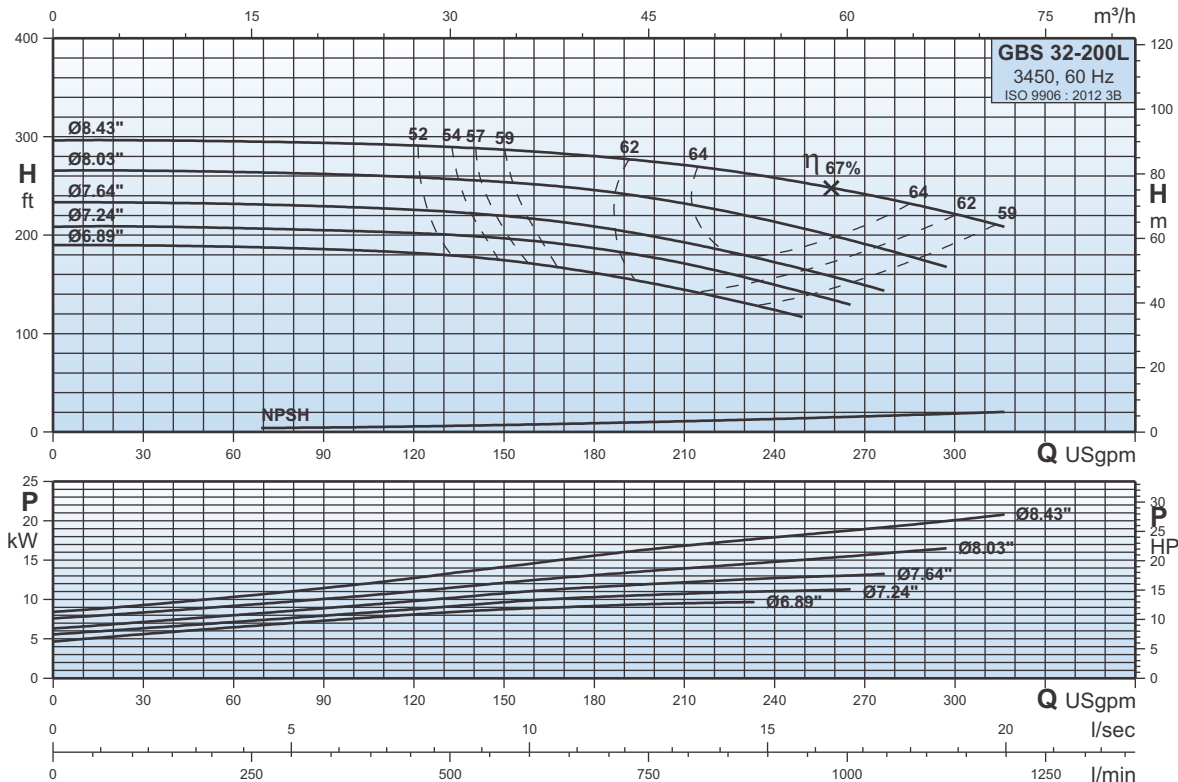

GBS 32-250

Curvas Características
Characteristic Curves
Courbes Caractéristiques

3450

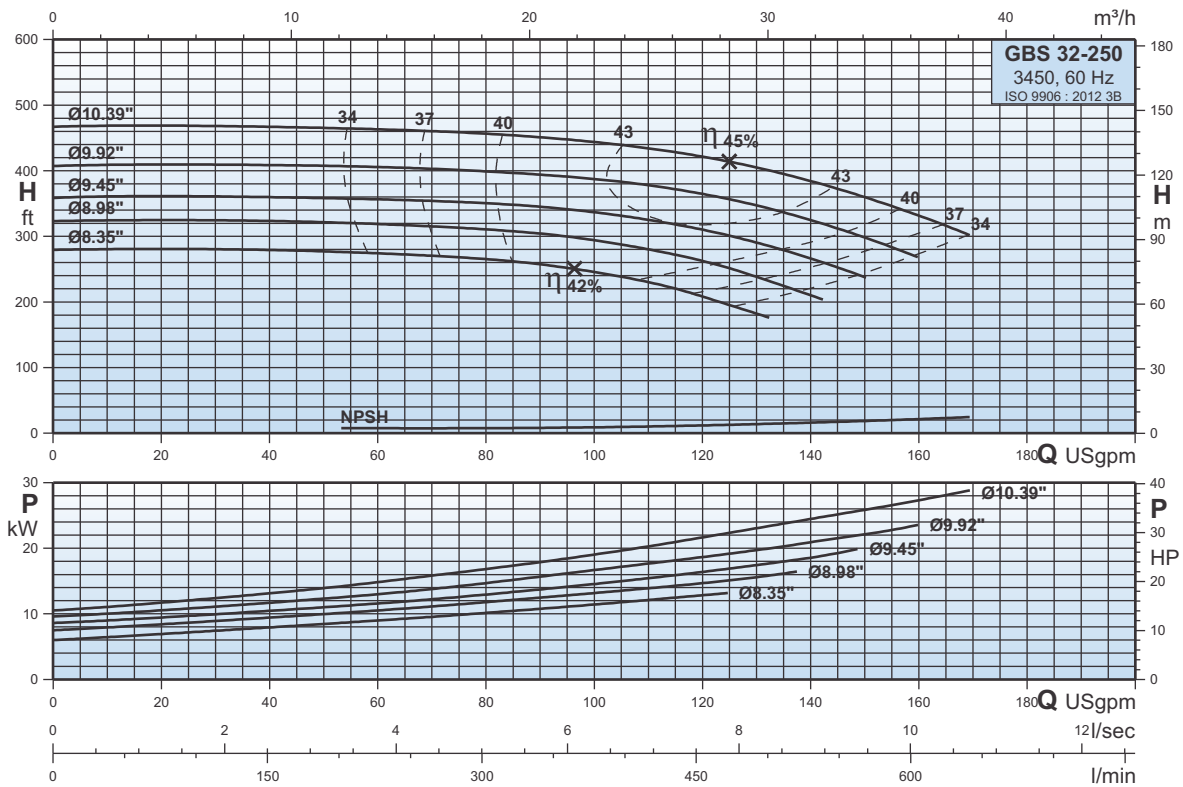

GBS 40-125

Curvas Características
Characteristic Curves
Courbes Caractéristiques

3450

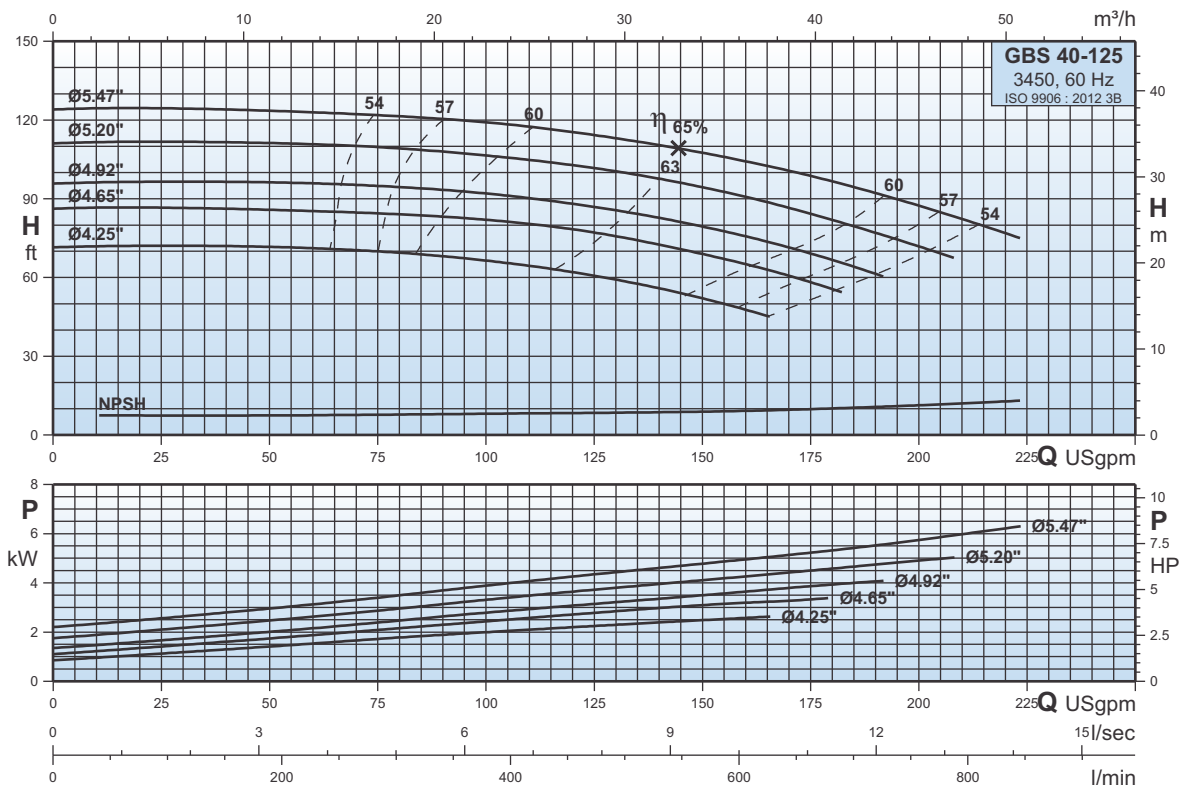

GBS 40-125L

Curvas Características
Characteristic Curves
Courbes Caractéristiques

3450

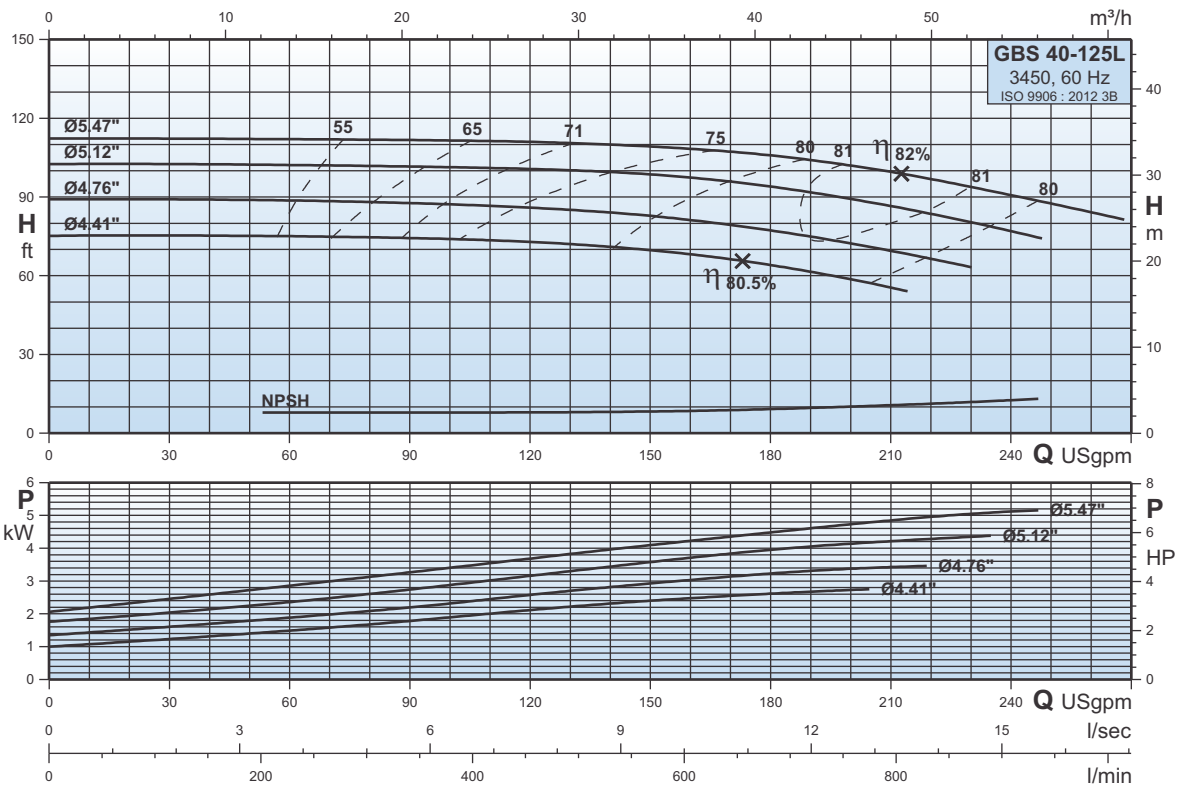

GBS 40-160

Curvas Características
Characteristic Curves
Courbes Caractéristiques

3450

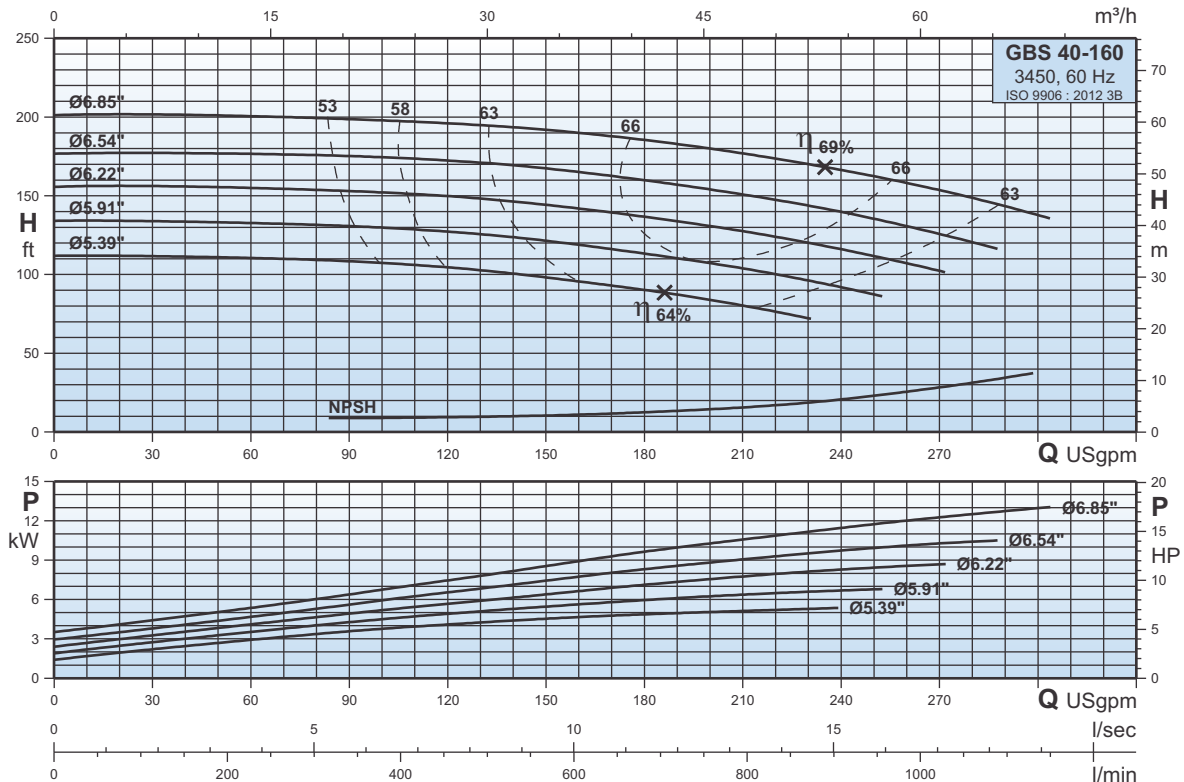

GBS 40-160H

Curvas Características
Characteristic Curves
Courbes Caractéristiques

3450

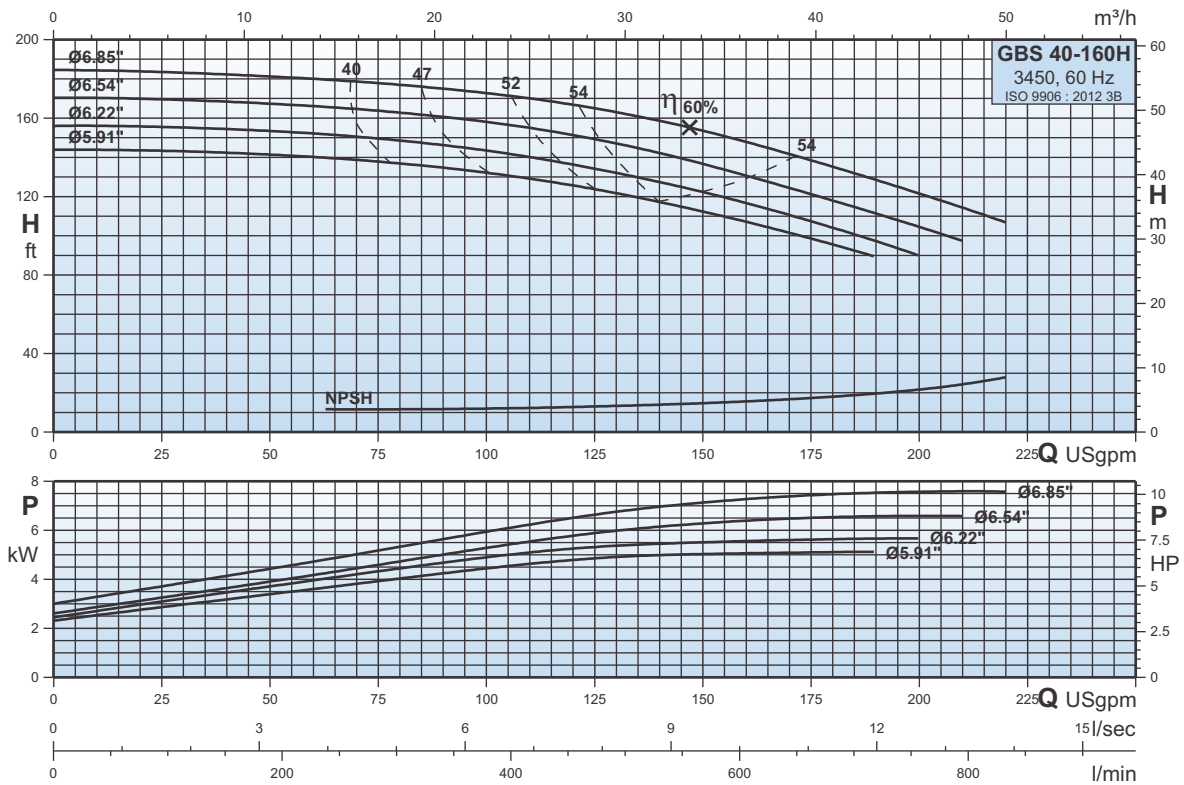

GBS 40-200

Curvas Características
Characteristic Curves
Courbes Caractéristiques

3450

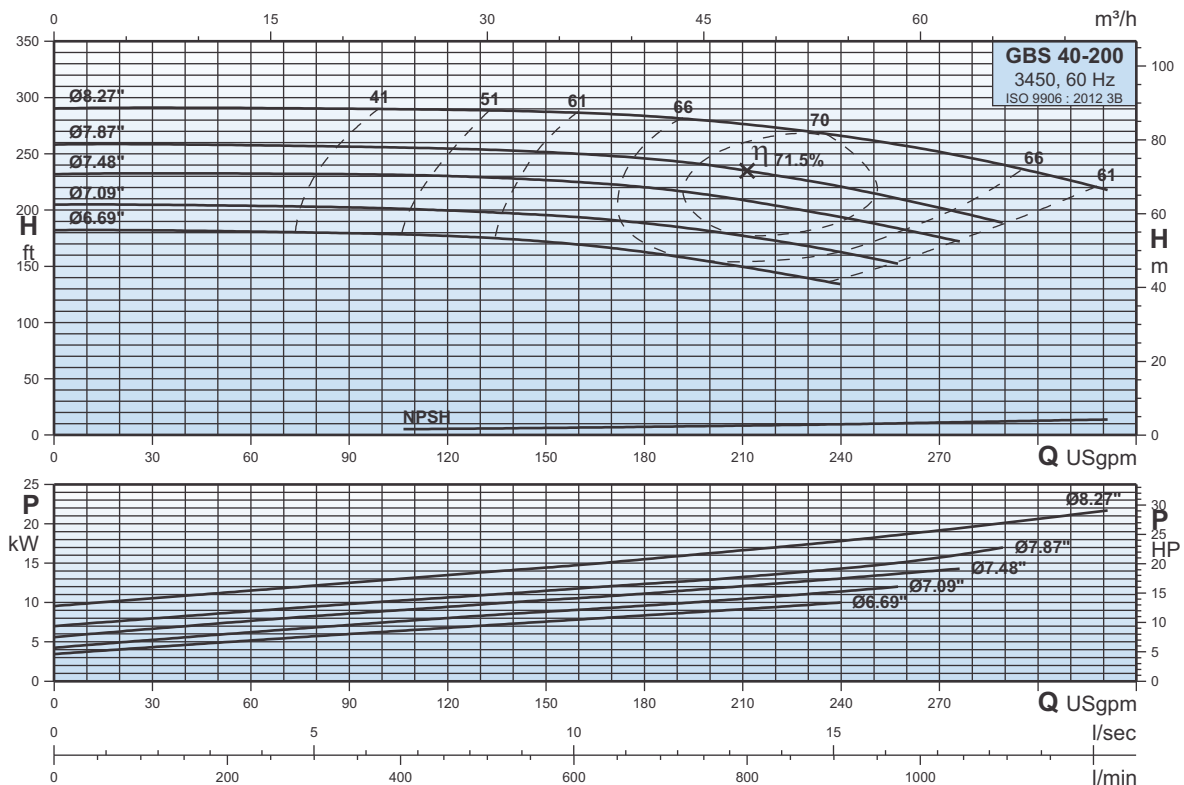

GBS 40-200H

Curvas Características
Characteristic Curves
Courbes Caractéristiques

3450

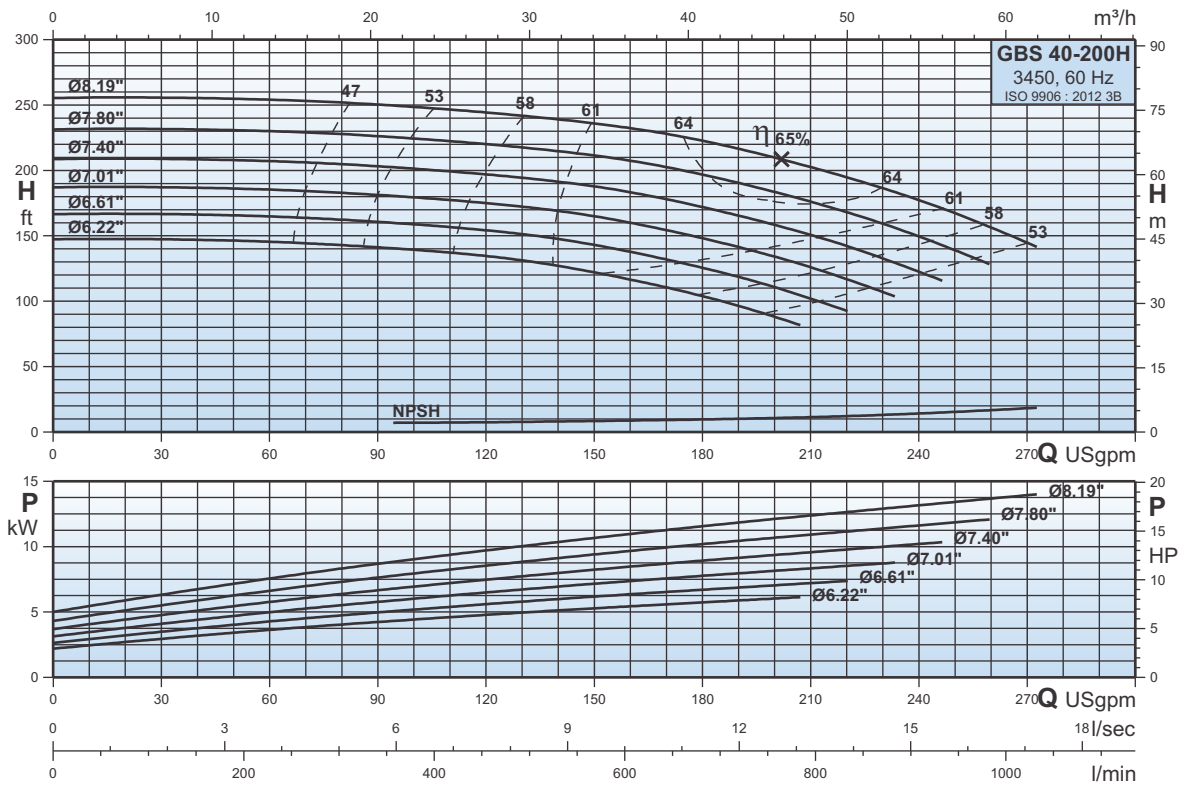

GBS 40-250

Curvas Características
Characteristic Curves
Courbes Caractéristiques

3450

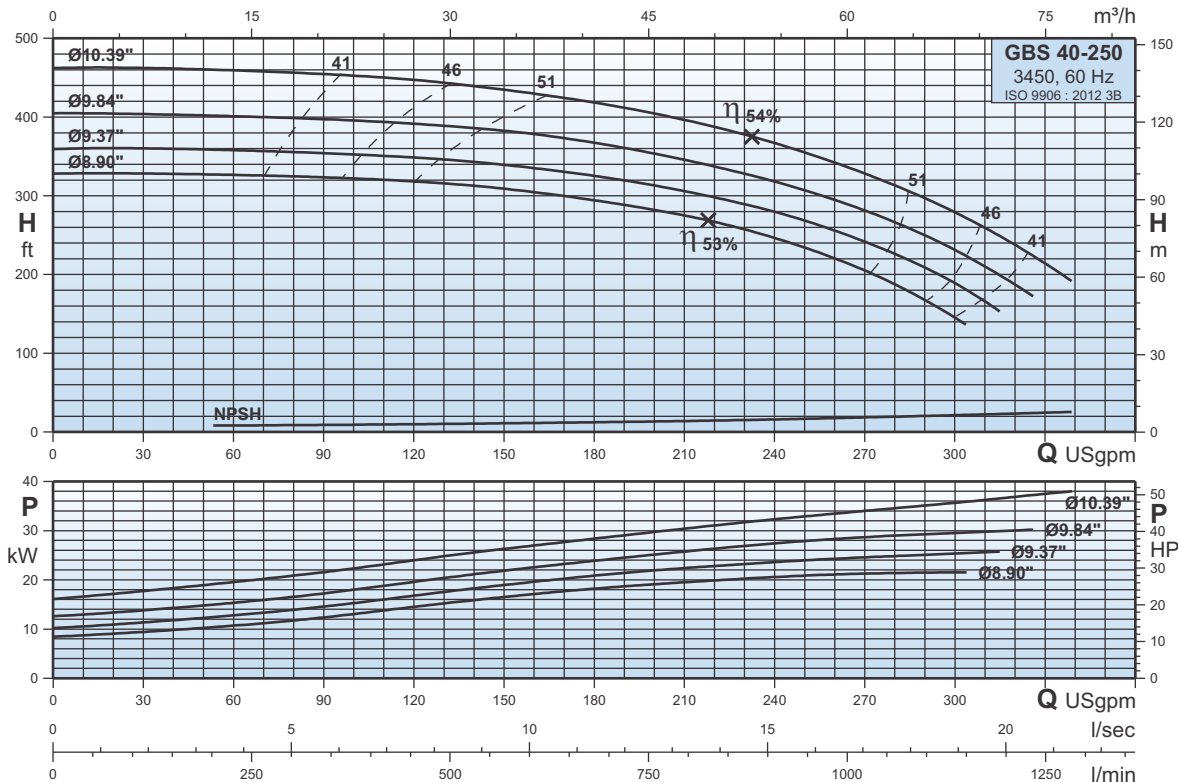

GBS 40-250L

Curvas Características
Characteristic Curves
Courbes Caractéristiques

3450

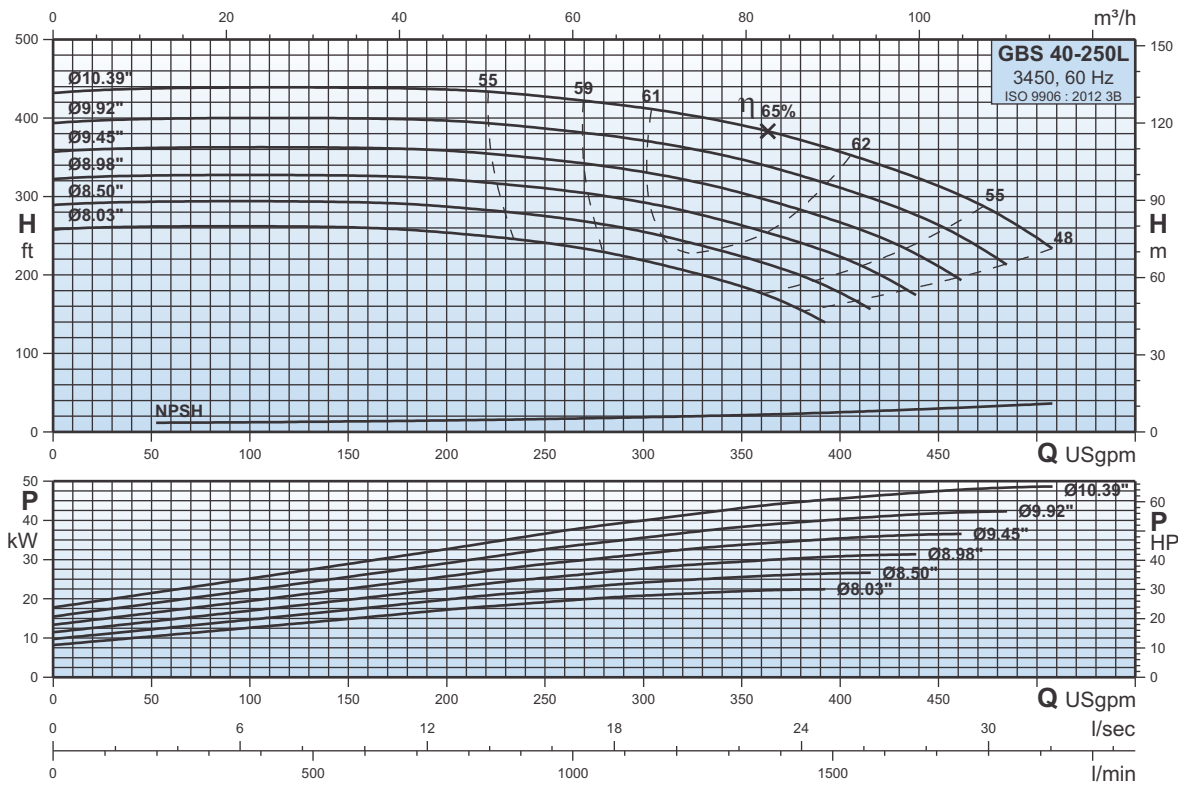

GBS 50-125

Curvas Características
Characteristic Curves
Courbes Caractéristiques

3450

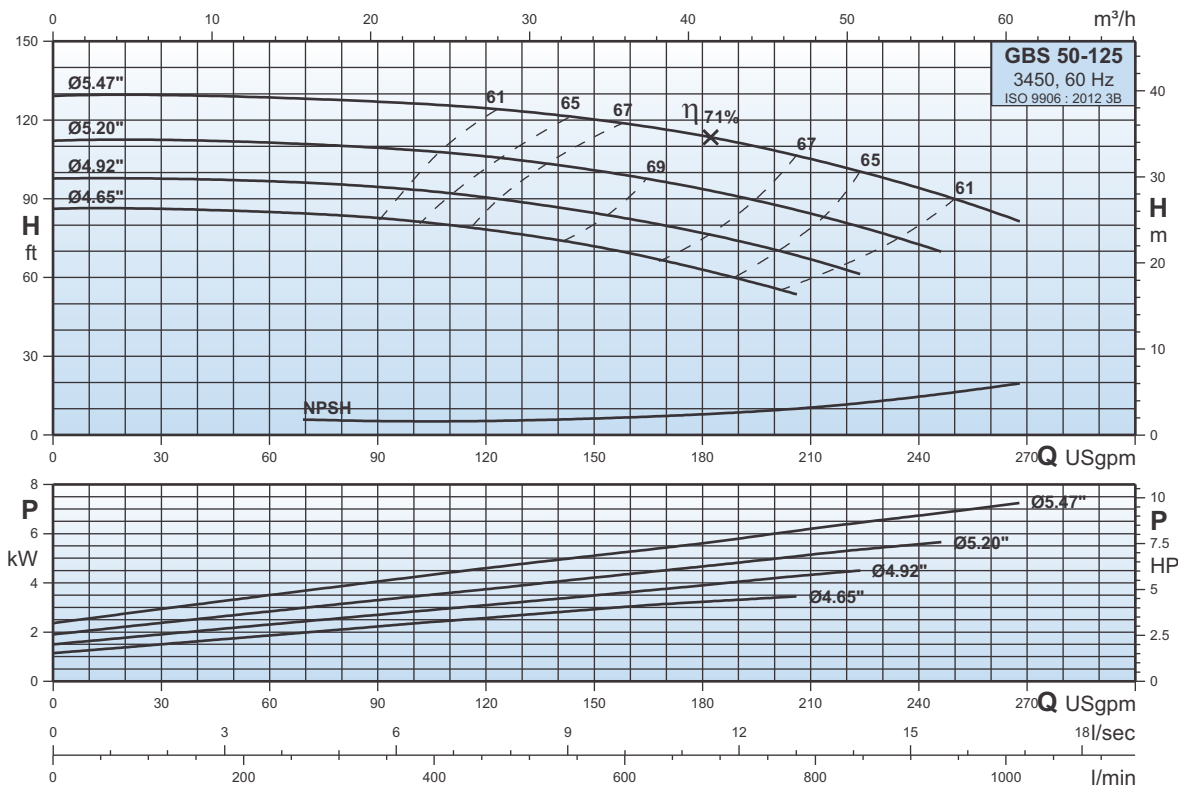

GBS 50-125L

Curvas Características
Characteristic Curves
Courbes Caractéristiques

3450

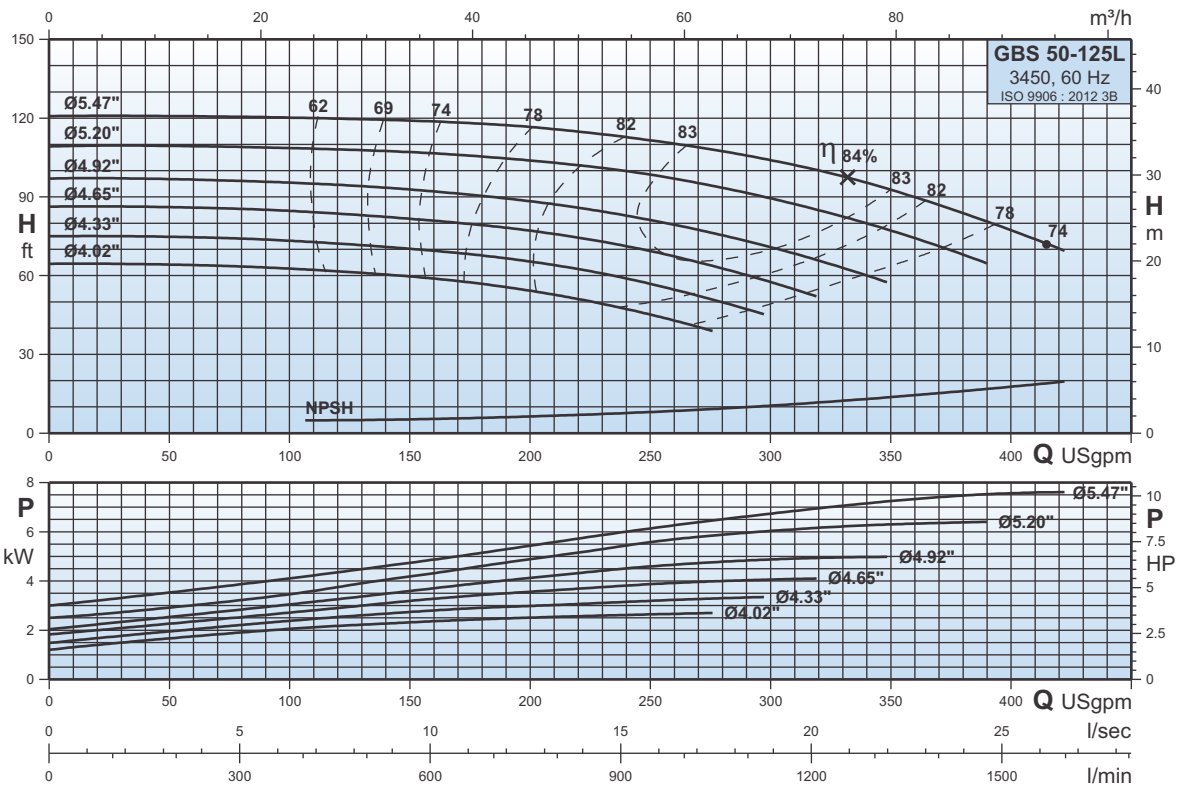

GBS 50-160

Curvas Características
Characteristic Curves
Courbes Caractéristiques

3450

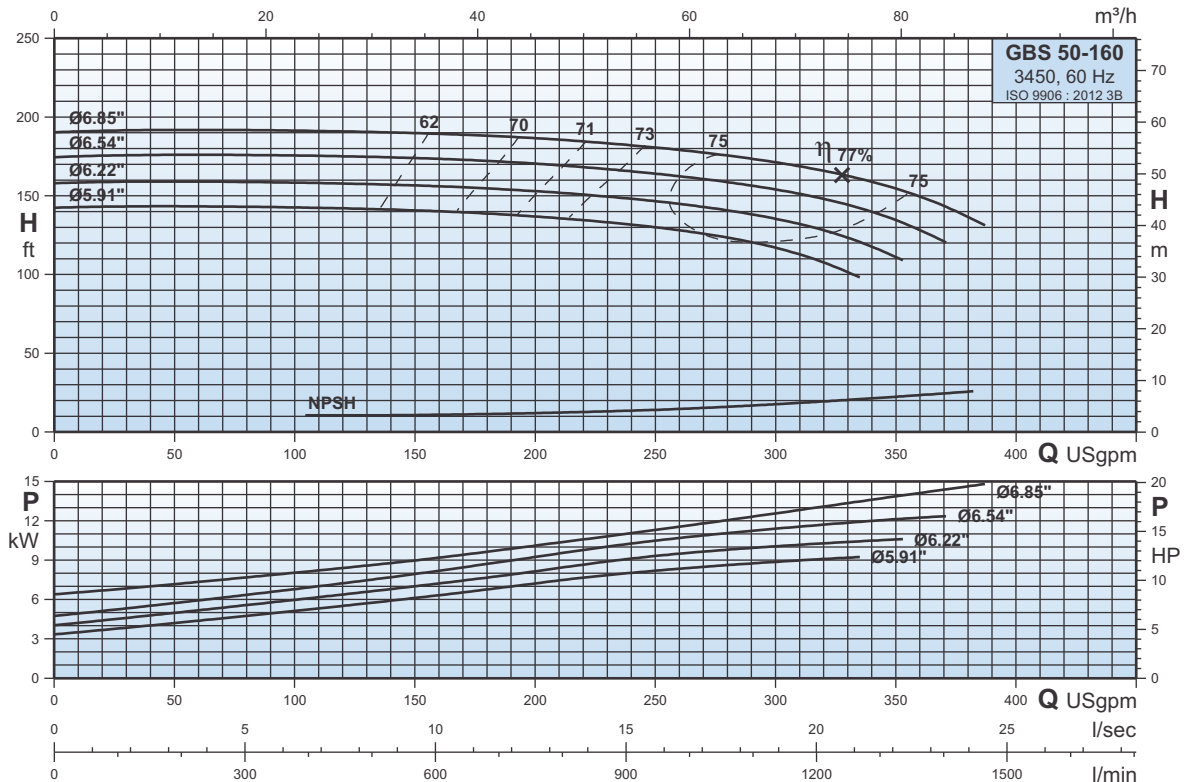

GBS 50-200

Curvas Características
Characteristic Curves
Courbes Caractéristiques

3450

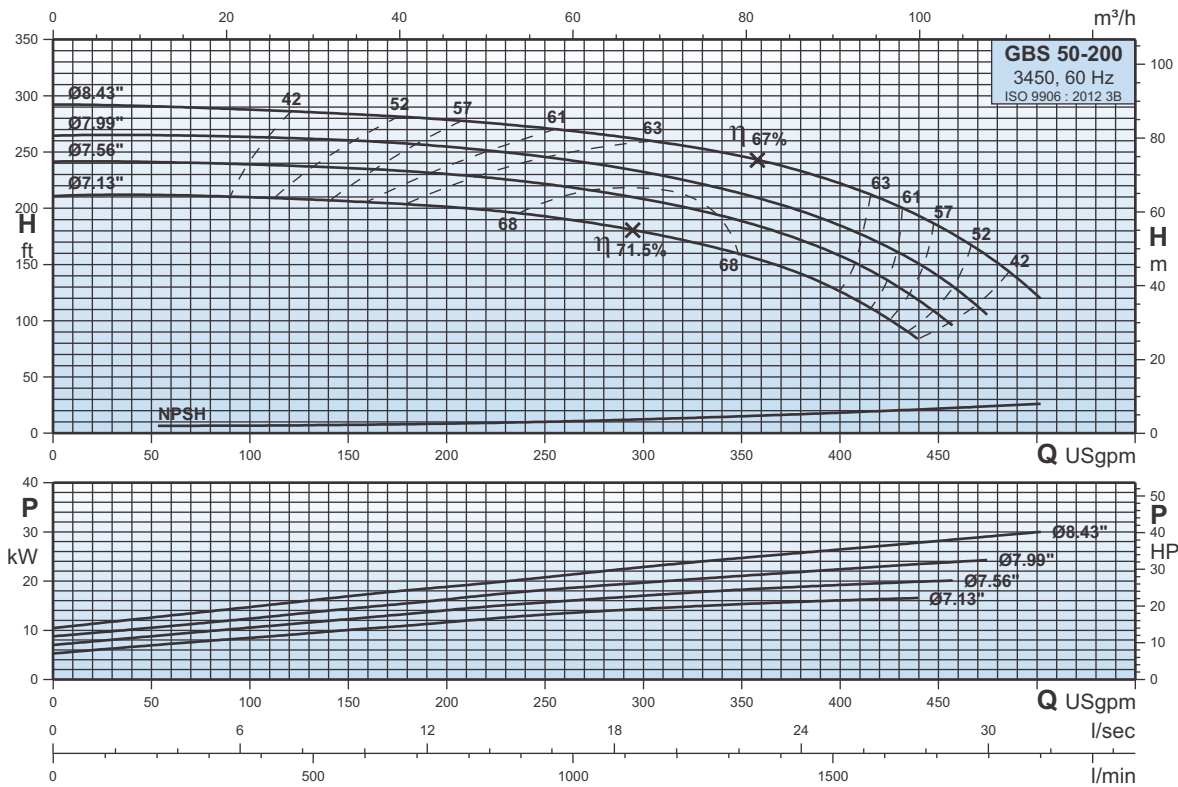

GBS 50-250

Curvas Características
Characteristic Curves
Courbes Caractéristiques

3450

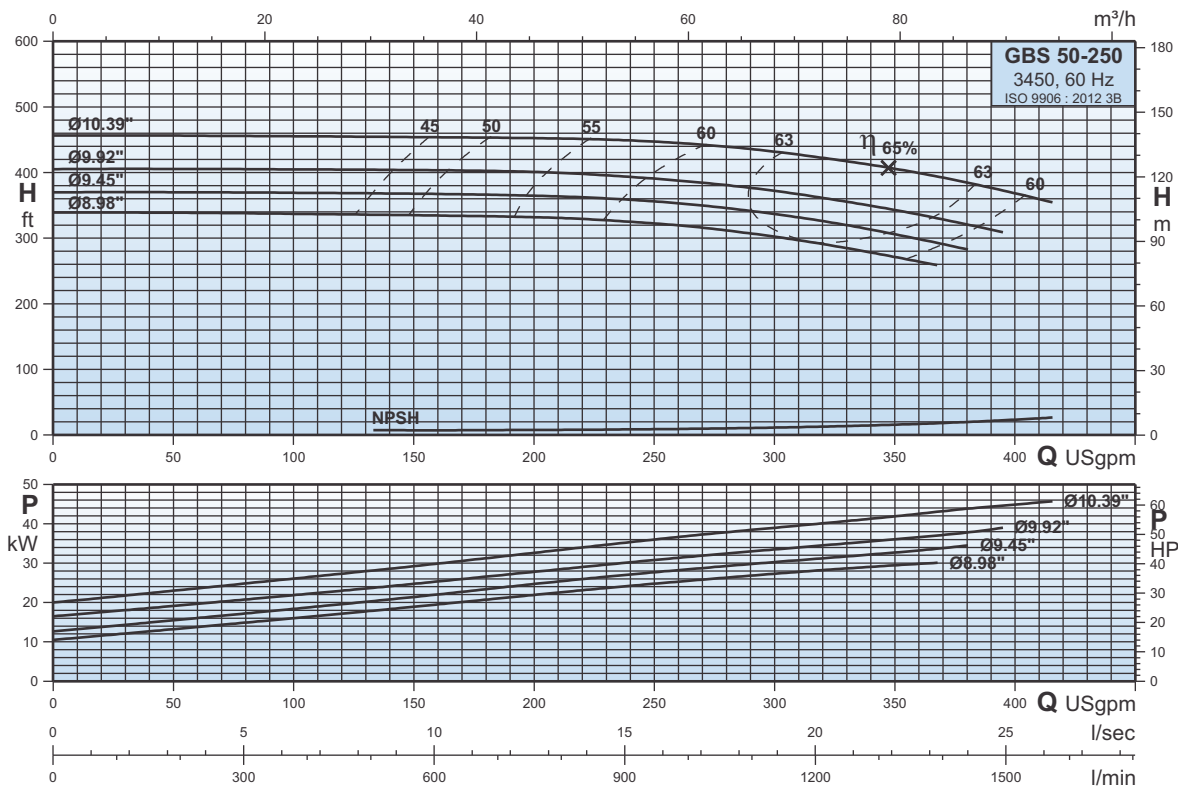

GBS 65-125

Curvas Características
Characteristic Curves
Courbes Caractéristiques

3450

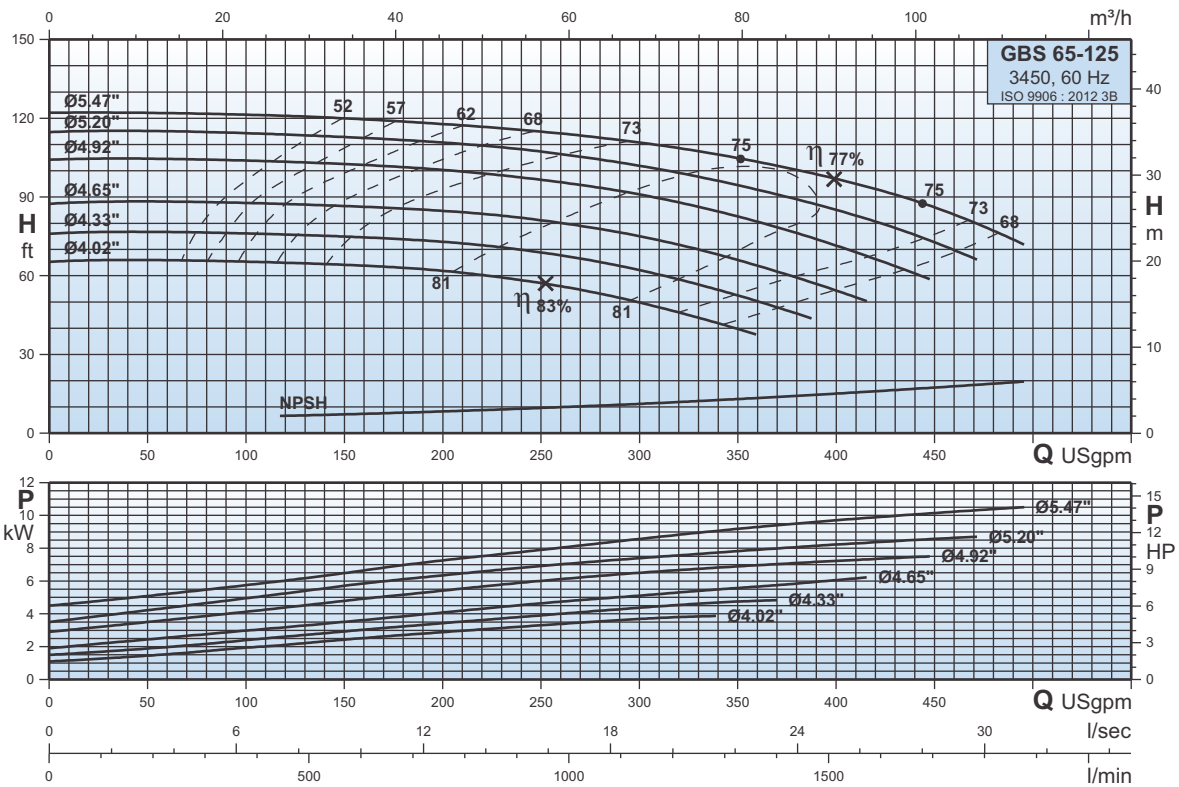

GBS 65-160

Curvas Características
Characteristic Curves
Courbes Caractéristiques

3450

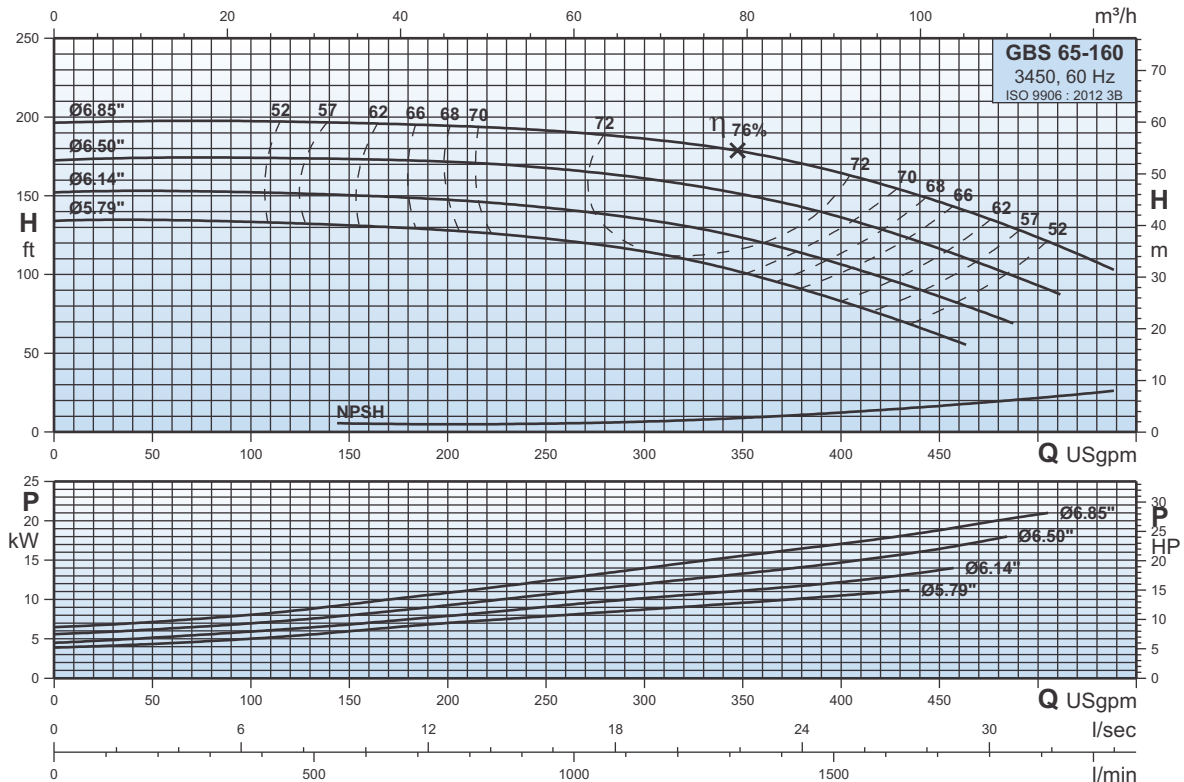

GBS 65-160L

Curvas Características
Characteristic Curves
Courbes Caractéristiques

3450

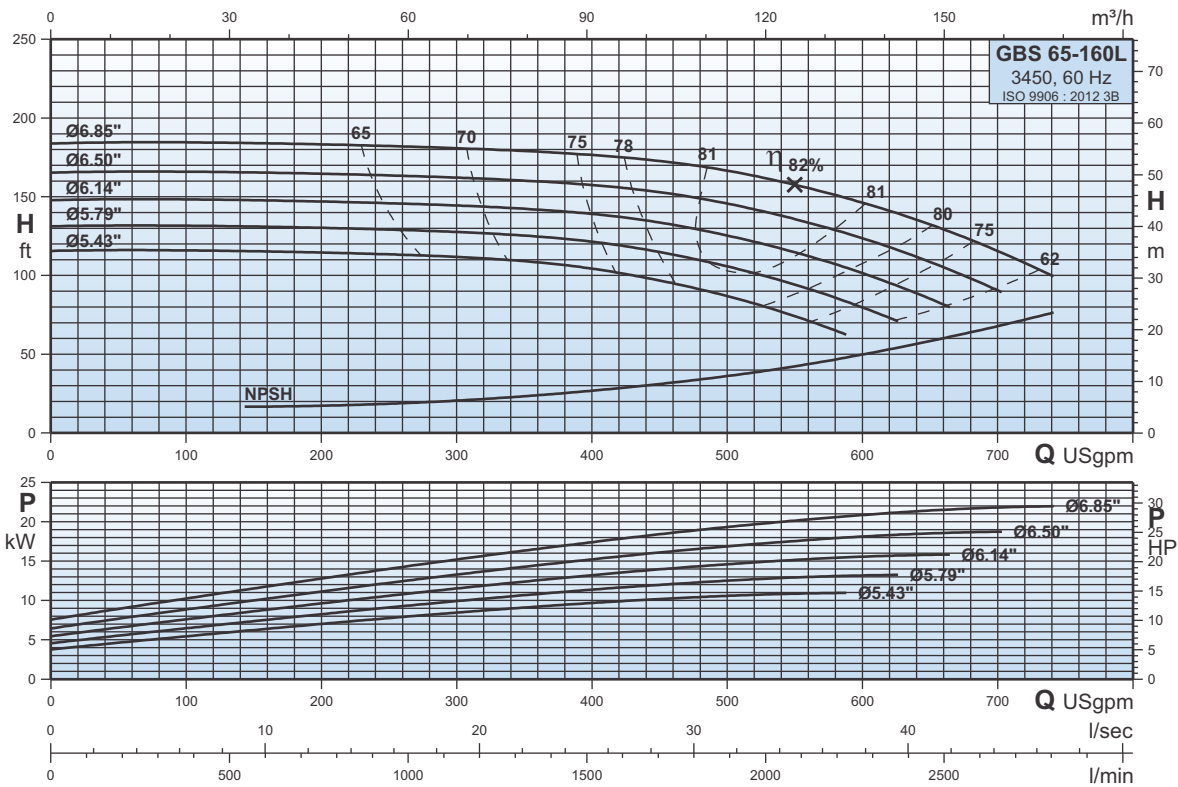

GBS 65-200

Curvas Características
Characteristic Curves
Courbes Caractéristiques

3450

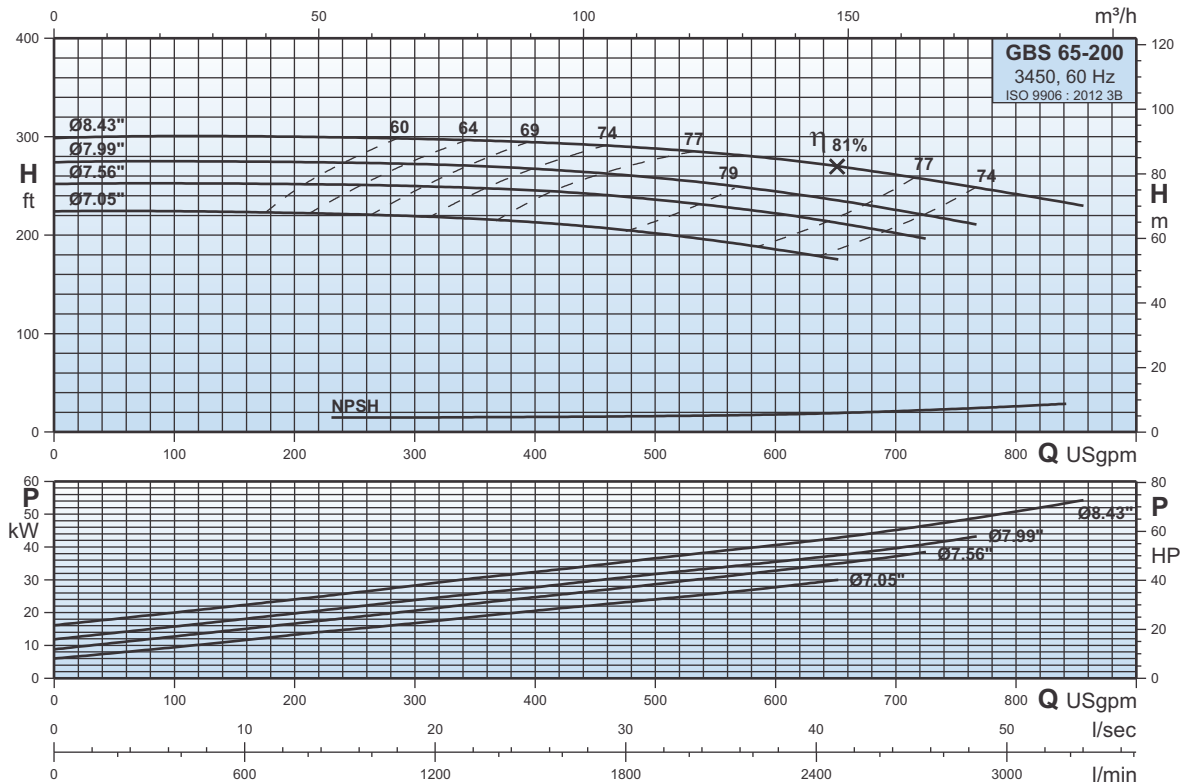

GBS 65-250

Curvas Características
Characteristic Curves
Courbes Caractéristiques

3450

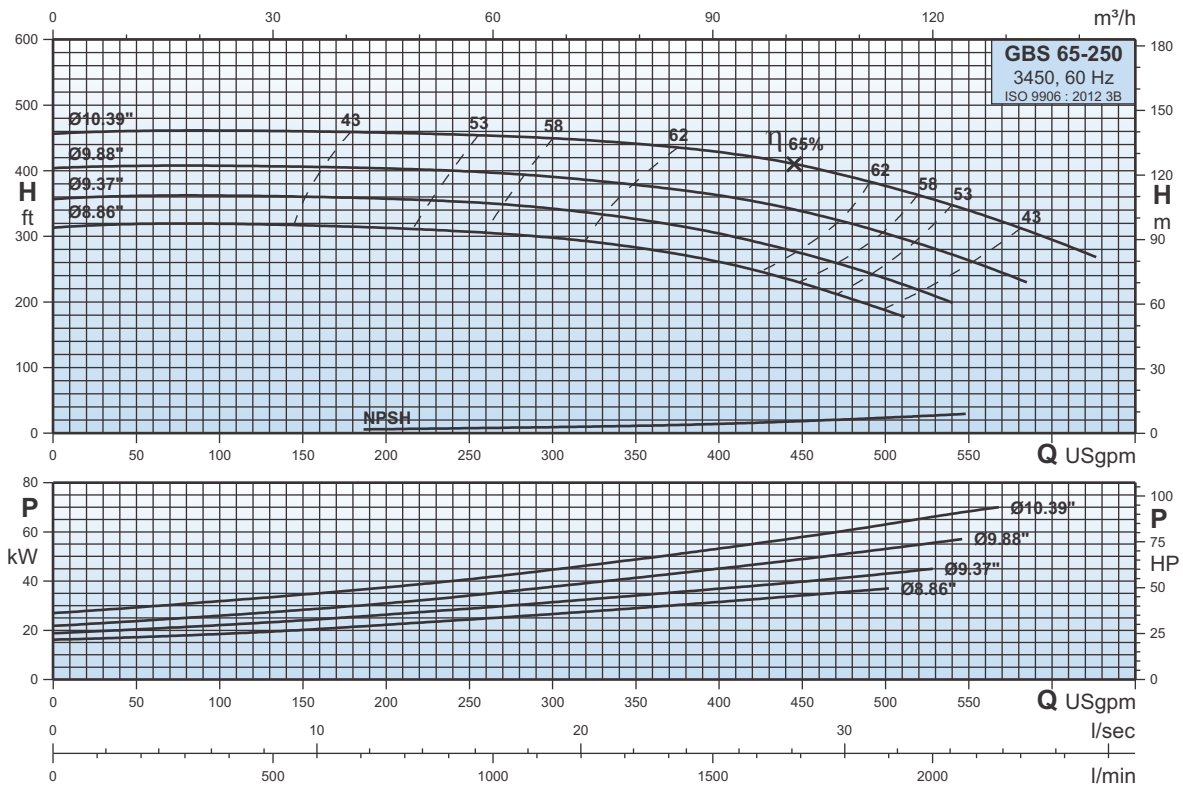

GBS 80-160

Curvas Características
Characteristic Curves
Courbes Caractéristiques

3450

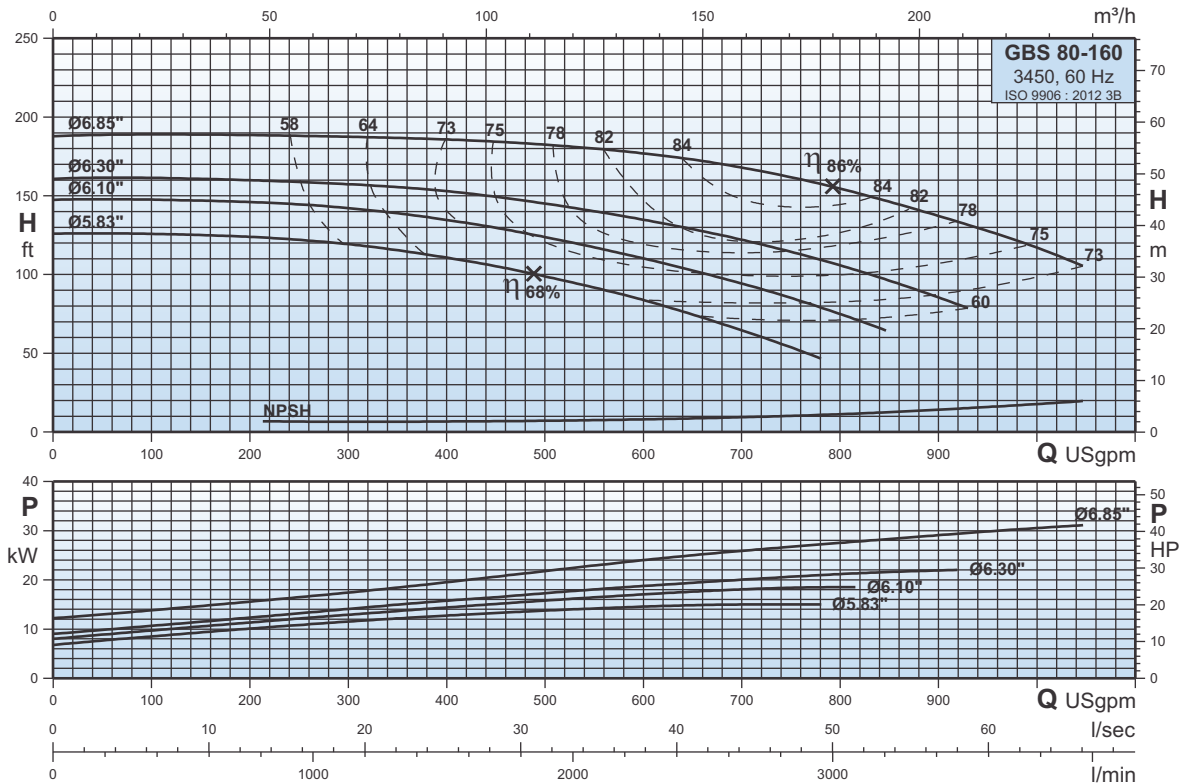

GBS 80-200

Curvas Características
Characteristic Curves
Courbes Caractéristiques

3450

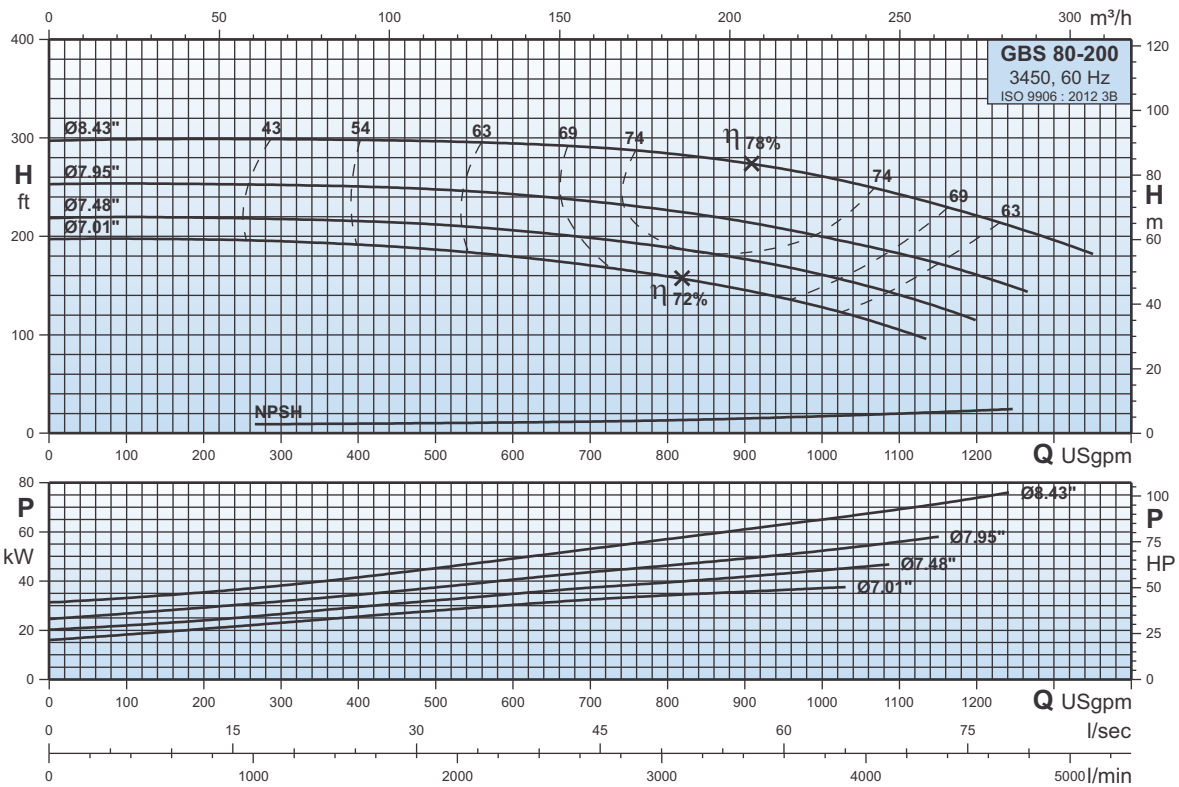

GBS 80-250

Curvas Características
Characteristic Curves
Courbes Caractéristiques

3450

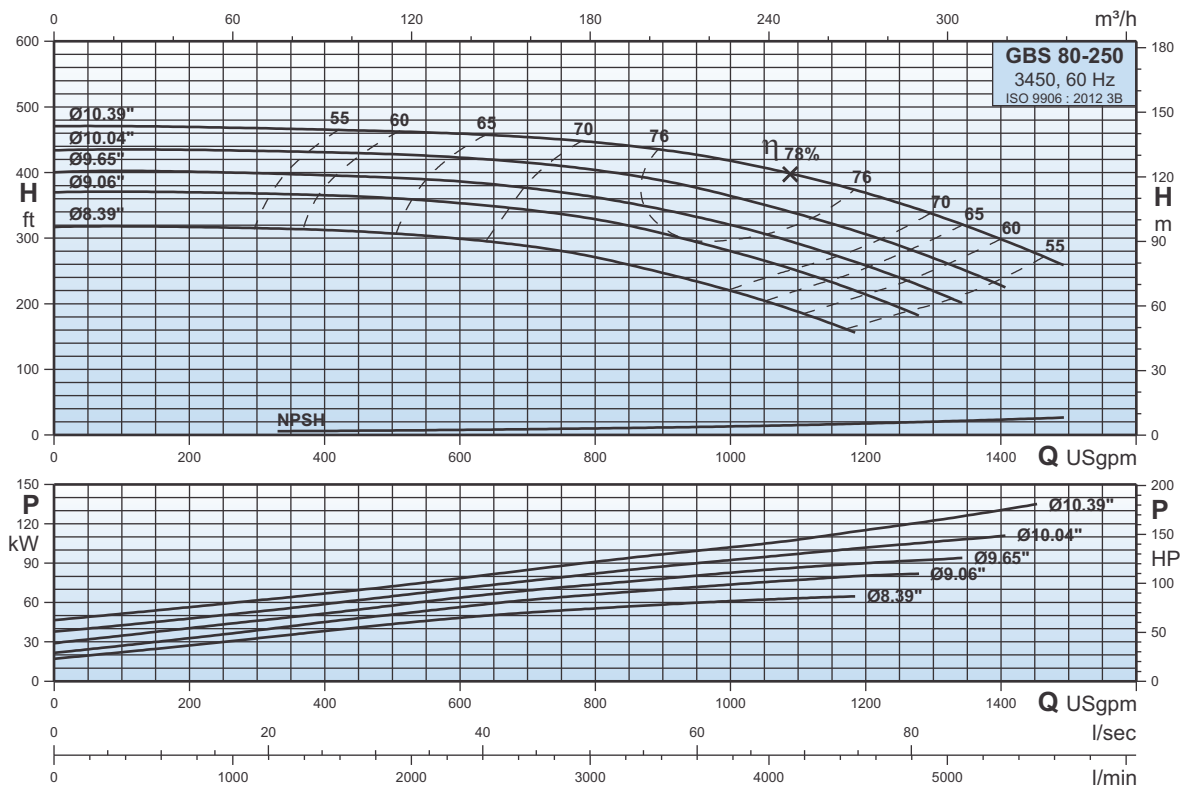

GBS 65-250L

Curvas Características
Characteristic Curves
Courbes Caractéristiques

3450

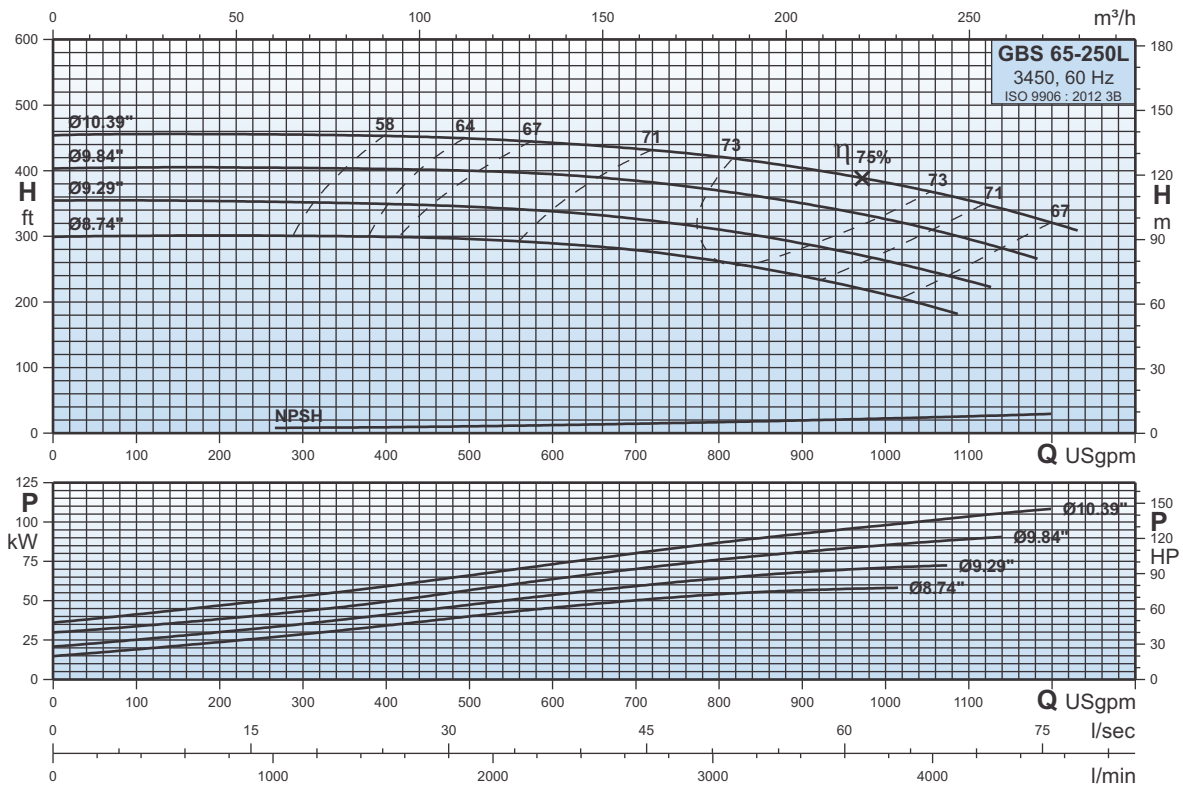

GBS 100-200

Curvas Características
Characteristic Curves
Courbes Caractéristiques

3450

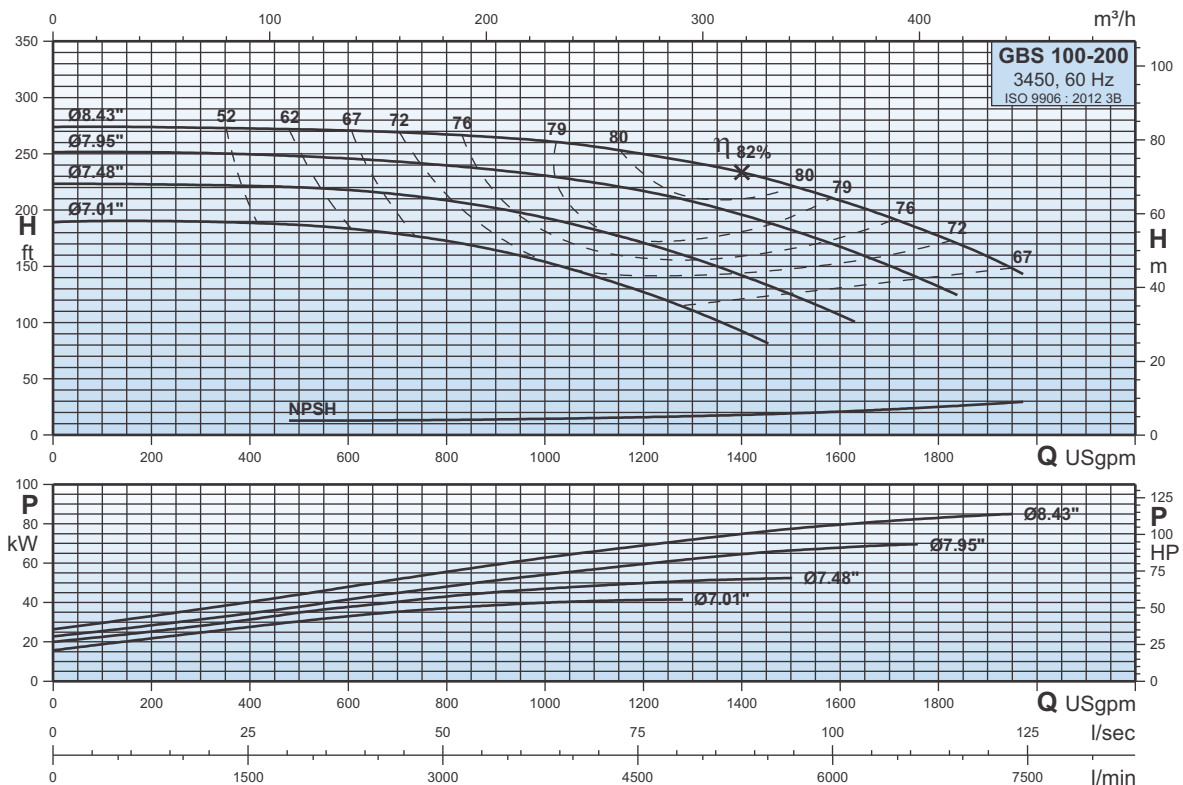

GBS 100-250

Curvas Características
Characteristic Curves
Courbes Caractéristiques

3450

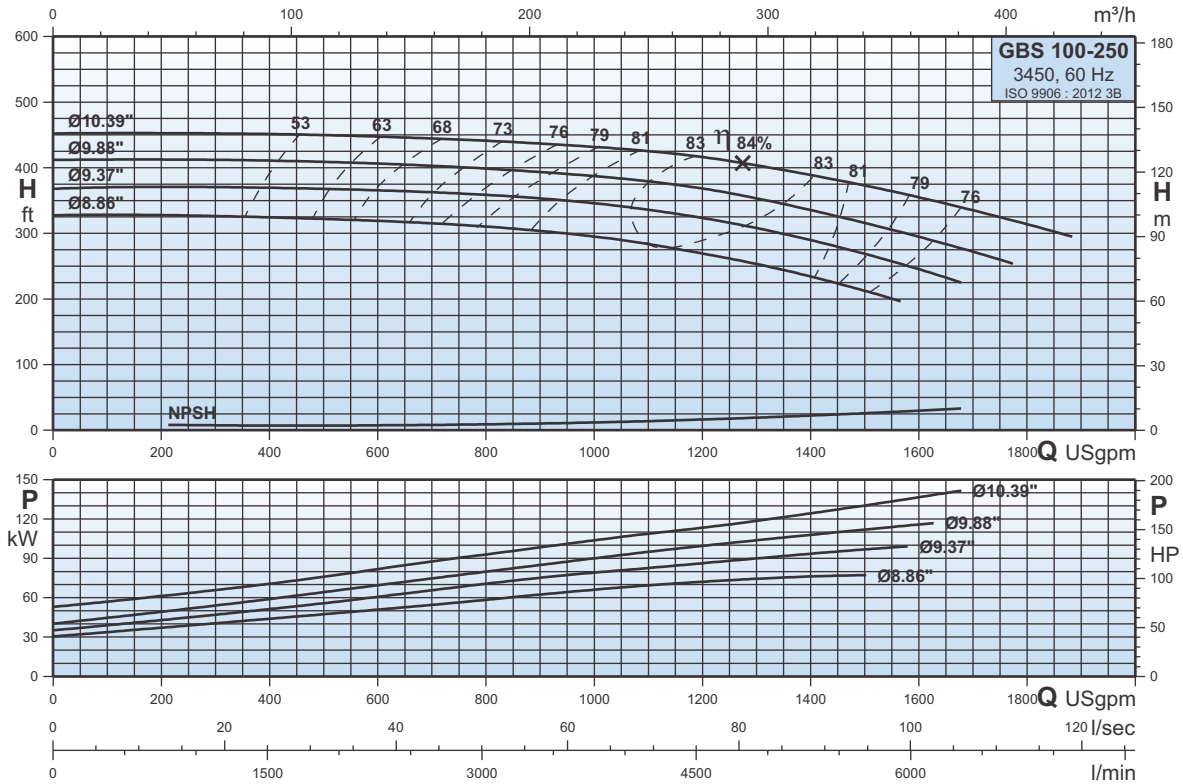

Dimensiones y pesos
Dimensions and Weights
Dimensions et poids

3450

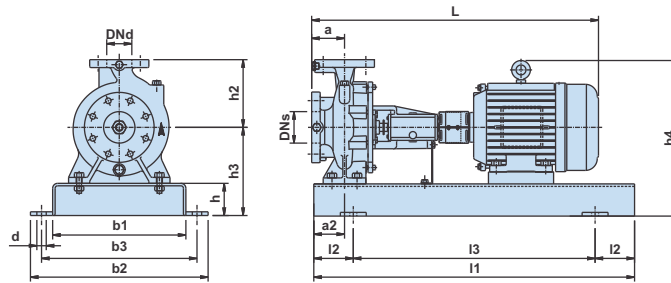

P ₂	[HP] [kW]	GBS 32-125				GBS 32-160				GBS 32-200				GBS 32-200L				GBS 32-250			
		2	3	4	5	5	7,5	10	15	7,5	10	15	20	15	20	25	30	20	25	30	40
Carcasa/Frame/Armature		145T	182T	184T	184T	184T	184T	215T	254T	184T	215T	254T	256T	254T	256T	284TS	286TS	256T	284TS	286TS	324TS
ANSI	[psi]	125	125	125	125	125	125	125	125	125	125	125	250	125	125	125	250	125	250	250	250
DN _s	[pulgadas/inch/pouces]	2,00	2,00	2,00	2,00	2,00	2,00	2,00	2,00	2,00	2,00	2,00	2,00	2,00	2,00	2,00	2,00	2,00	2,00	2,00	2,00
DN _d	[pulgadas/inch/pouces]	1,25	1,25	1,25	1,25	1,25	1,25	1,25	1,25	1,25	1,25	1,25	1,25	1,25	1,25	1,25	1,25	1,25	1,25	1,25	1,25
a	[pulgadas/inch/pouces]	3,15	3,15	3,15	3,15	3,15	3,15	3,15	3,15	3,15	3,15	3,15	3,15	3,15	3,15	3,15	3,15	3,94	3,94	3,94	3,94
h ₂	[pulgadas/inch/pouces]	5,51	5,51	5,51	5,51	6,30	6,30	6,30	6,30	7,09	7,09	7,09	7,09	7,09	7,09	7,09	7,09	8,86	8,86	8,86	8,86
L	[pulgadas/inch/pouces]	31,30	33,90	33,90	33,90	33,90	35,87	37,99	41,38	35,87	37,99	41,38	43,03	41,38	43,03	45,28	46,77	43,82	46,06	47,56	49,13
I ₁	[pulgadas/inch/pouces]	35,43	35,43	35,43	35,43	35,43	35,43	39,37	44,09	35,43	39,37	44,09	44,09	44,09	44,09	44,09	44,09	49,21	49,21	49,21	55,12
I ₂	[pulgadas/inch/pouces]	5,90	5,90	5,90	5,90	5,90	5,90	6,69	7,48	5,91	6,69	7,48	7,48	7,48	7,48	7,48	7,48	8,07	8,07	8,07	9,06
I ₃	[pulgadas/inch/pouces]	23,62	23,62	23,62	23,62	23,62	23,62	25,98	29,13	23,62	25,98	29,13	29,13	29,13	29,13	29,13	29,13	33,07	33,07	33,07	37,01
b ₁	[pulgadas/inch/pouces]	11,81	11,81	11,81	11,81	11,81	11,81	13,39	14,96	11,81	13,39	14,96	14,96	14,96	14,96	14,96	14,96	16,93	16,93	16,93	18,90
b ₂	[pulgadas/inch/pouces]	15,35	15,35	15,35	15,35	15,35	15,35	17,72	19,29	15,35	17,72	19,29	19,29	19,29	19,29	19,29	19,29	21,26	21,26	21,26	24,02
b ₃	[pulgadas/inch/pouces]	13,77	13,77	13,77	13,77	13,77	13,77	15,75	17,32	13,78	15,75	17,32	17,32	17,32	17,32	17,32	17,32	19,29	19,29	19,29	21,65
d	[pulgadas/inch/pouces]	0,74	0,74	0,74	0,74	0,74	0,74	0,94	0,94	0,75	0,94	0,94	0,94	0,94	0,94	0,94	0,94	0,94	0,94	0,94	1,10
a ₂	[pulgadas/inch/pouces]	2,36	2,36	2,36	2,36	2,36	2,36	2,36	2,36	2,36	2,36	2,36	2,36	2,36	2,36	2,36	2,36	2,95	2,95	2,95	2,95
h	[pulgadas/inch/pouces]	2,55	2,55	2,55	2,55	2,55	2,55	3,15	3,15	2,56	3,15	3,15	3,15	3,15	3,15	3,15	3,15	3,15	3,15	3,15	3,94
h ₃	[pulgadas/inch/pouces]	6,97	6,97	6,97	6,97	7,76	7,76	8,35	9,45	8,86	9,45	9,45	9,45	9,45	9,45	10,16	10,16	10,24	10,24	10,24	11,81
h ₄	[pulgadas/inch/pouces]	12,20	13,11	13,11	13,11	13,90	13,82	15,67	18,19	14,92	16,77	18,19	18,19	18,19	18,19	19,65	19,65	18,98	19,76	19,76	21,93
Tipo de bancada numero Base frame type no. Número du type d'armature		3	3	3	3	3	3	4	5	3	4	5	5	5	5	5	5	6	6	6	7
Peso neto Net weight Poids net	[lbs]	147	174	179	184	204	223	296	330	234	307	391	424	386	419	579	612	449	608	641	821
Peso bruto Gross weight Poids brut	[lbs]	266	293	298	303	323	342	465	499	253	476	560	593	555	588	748	781	657	846	879	1059
Volumen bruto Gross volume Volume brut	[ft ³]	12,92	12,92	12,92	12,92	12,92	12,92	22,70	22,70	12,92	22,70	22,70	22,70	22,70	22,70	22,70	22,70	38,10	38,10	38,10	38,10

P ₂	[HP] [kW]	GBS 40-125				GBS 40-125L				GBS 40-160				GBS 40-160H				GBS 40-200				GBS 40-200H			
		4	5	7,5	10	4	5	7,5	7,5	7,5	10	15	20	5	7,5	10	15	15	20	25	30	7,5	10	15	20
Carcasa/Frame/Armature		184T	184T	184T	215T	184T	184T	184T	184T	215T	254T	256T	184T	184T	215T	254T	256T	284TS	286TS	184T	215T	254T	256T		
ANSI	[psi]	125	125	125	125	125	125	125	125	125	125	125	125	125	125	125	125	125	125	125	125	125	125	125	125
DN _s	[pulgadas/inch/pouces]	2,50	2,50	2,50	2,50	2,50	2,50	2,50	2,50	2,50	2,50	2,50	2,50	2,50	2,50	2,50	2,50	2,50	2,50	2,50	2,50	2,50	2,50	2,50	2,50
DN _d	[pulgadas/inch/pouces]	1,50	1,50	1,50	1,50	1,50	1,50	1,50	1,50	1,50	1,50	1,50	1,50	1,50	1,50	1,50	1,50	1,50	1,50	1,50	1,50	1,50	1,50	1,50	1,50
a	[pulgadas/inch/pouces]	3,15	3,15	3,15	3,15	3,15	3,15	3,15	3,15	3,15	3,15	3,15	3,15	3,15	3,15	3,15	3,15	3,94	3,94	3,94	3,94	3,94	3,94	3,94	3,94
h ₂	[pulgadas/inch/pouces]	5,51	5,51	5,51	7,09	5,51	5,51	5,51	6,30	6,30	6,30	6,30	6,30	6,30	6,30	6,30	6,30	7,09	7,09	7,09	7,09	7,09	7,09	7,09	7,09
L	[pulgadas/inch/pouces]	33,90	33,90	35,87	37,99	33,90	33,90	35,87	35,87	37,99	41,38	43,03	35,16	35,87	37,99	42,17	43,82	46,06	47,56	36,65	38,07	42,17	43,82		
I ₁	[pulgadas/inch/pouces]	35,43	35,43	35,43	39,37	35,43	35,43	35,43	35,43	39,37	44,09	44,09	35,43	35,43	39,37	44,09	44,09	44,09	44,09	35,43	39,37	44,09	44,09		
I ₂	[pulgadas/inch/pouces]	5,91	5,91	5,91	6,69	5,91	5,91	5,91	5,91	6,69	7,48	7,48	5,91	5,91	6,69	7,48	7,48	7,48	7,48	5,91	6,69	7,48	7,48		
I ₃	[pulgadas/inch/pouces]	23,62	23,62	23,62	25,98	23,62	23,62	23,62	23,62	25,98	29,13	29,13	23,62	23,62	25,98	29,13	29,13	29,13	29,13	23,62	25,98	29,13	29,13		
b ₁	[pulgadas/inch/pouces]	11,81	11,81	11,81	13,39	11,81	11,81	11,81	11,81	13,39	14,96	14,96	11,81	11,81	13,39	14,96	14,96	14,96	14,96	11,81	13,39	14,96	14,96		
b ₂	[pulgadas/inch/pouces]	15,35	15,35	15,35	17,72	15,35	15,35	15,35	15,35	17,72	19,29	19,29	15,35	15,35	17,72	19,29	19,29	19,29	19,29	15,35	17,72	19,29	19,29		
b ₃	[pulgadas/inch/pouces]	13,78	13,78	13,78	15,75	13,78	13,78	13,78	13,78	15,75	17,32	17,32	13,78	13,78	15,75	17,32	17,32	17,32	17,32	13,78	15,75	17,32	17,32		
d	[pulgadas/inch/pouces]	0,75	0,75	0,75	0,94	0,75	0,75	0,75	0,94	0,94	0,94	0,94	0,75	0,75	0,94	0,94	0,94	0,94	0,94	0,75	0,94	0,94	0,94		
a ₂	[pulgadas/inch/pouces]	2,36	2,36	2,36	2,36	2,36	2,36	2,36	2,36	2,36	2,36	2,36	2,36	2,36	2,36	2,36	2,36	2,36	2,36	2,36	2,36	2,36	2,36		
h	[pulgadas/inch/pouces]	2,56	2,56	2,56	3,15	2,56	2,56	2,56	2,56	3,15	3,15	3,15	2,56	2,56	3,15	3,15	3,15	3,15	3,15	2,56	3,15	3,15	3,15		
h ₃	[pulgadas/inch/pouces]	6,97	6,97	6,97	8,35	6,97	6,97	6,97	7,76	8,35	9,45	9,45	7,76	7,76	8,35	9,45	9,45	9,45	9,45	8,86	9,45	9,45	9,45		
h ₄	[pulgadas/inch/pouces]	13,11	13,11	13,03	15,67	13,11	13,11	13,03	13,82	15,67	18,19	18,19	13,82	13,82	15,67	18,19	18,19	19,65	19,65	14,92	16,77	18,19	18,19		
Tipo de bancada numero Base frame type no. Número du type d'armature		3	3	3	4	3	3	3	3	4	5	5	3	3	4	5	5	5	5	3	4	5	5		
Peso neto Net weight Poids net	[lbs]	184	188	208	281	184	188	208	215	287	371	404	196	215	287	382	415	574	607	227	299	382	415		
Peso bruto Gross weight Poids brut	[lbs]	303	307	327	450	303	307	327	334	456	540	573	218	334	456	551	584	743	776	249	440	551	584		
Volumen bruto Gross volume Volume brut	[ft ³]	12,92	12,92	12,92	22,70	12,92	12,92	12,92	12,92	22,70	22,70	22,70	7,66	12,92	22,70	22,70	22,70	22,70	22,70	7,66	17,33	22,70	22,70		

Nota: Todas las medidas estan basadas con acoplamiento estandar, las dimensiones cambian con el acoplamiento espaciador.

Note: All dimensions are based on standard coupling, dimensions will change for spacer coupling.

Note: Toutes les dimensions sont fondées sur la norme coupling, les dimensions changeront pour l'entretoise coupling.

Dimensiones y pesos
Dimensions and Weights
Dimensions et poids

3450

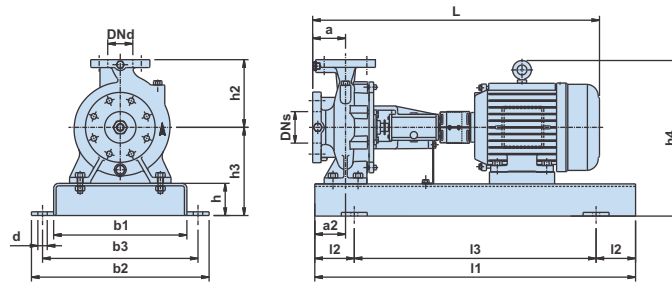

P ₂	[HP]	GBS 40-250				GBS 40-250L				GBS 50-125				GBS 50-125L			
	[kW]	25	30	40	50	30	40	50	60	4	5	7,5	10	4	5	7,5	10
Carcasa/Frame/Armature		284TS	286TS	324TS	326TS	286TS	324TS	326TS	364TS	184T	184T	184T	215T	184T	184T	184T	215T
ANSI	[psi]	250	250	250	250	125	250	250	250	125	125	125	125	125	125	125	125
DN _s	[pulgadas/inch/pouces]	2,50	2,50	2,50	2,50	2,50	2,50	2,50	2,50	2,50	2,50	2,50	2,50	2,50	2,50	2,50	2,50
DN _d	[pulgadas/inch/pouces]	1,50	1,50	1,50	1,50	1,50	1,50	1,50	1,50	2,00	2,00	2,00	2,00	2,00	2,00	2,00	2,00
a	[pulgadas/inch/pouces]	3,94	3,94	3,94	3,94	3,94	3,94	3,94	3,94	3,94	3,94	3,94	3,94	3,94	3,94	3,94	3,94
h ₂	[pulgadas/inch/pouces]	8,86	8,86	8,86	8,86	8,86	8,86	8,86	8,86	6,30	6,30	6,30	6,30	6,30	6,30	6,30	6,30
L	[pulgadas/inch/pouces]	46,02	47,56	49,13	49,13	47,56	49,13	49,13	49,57	34,69	34,69	36,65	37,99	34,69	34,69	36,65	37,99
l ₁	[pulgadas/inch/pouces]	49,21	49,21	55,12	55,12	49,21	55,12	55,12	55,12	35,43	35,43	35,43	39,37	35,43	35,43	35,43	39,37
l ₂	[pulgadas/inch/pouces]	8,07	8,07	9,06	9,06	8,07	9,06	9,06	9,06	5,91	5,91	5,91	6,69	5,91	5,91	5,91	6,69
l ₃	[pulgadas/inch/pouces]	33,07	33,07	37,01	37,01	33,07	37,01	37,01	37,01	23,62	23,62	23,62	25,98	23,62	23,62	23,62	25,98
b ₁	[pulgadas/inch/pouces]	16,93	16,93	18,90	18,90	16,93	18,90	18,90	18,90	11,81	11,81	11,81	13,39	11,81	11,81	11,81	13,39
b ₂	[pulgadas/inch/pouces]	21,26	21,26	24,02	24,02	21,26	24,02	24,02	24,02	15,35	15,35	15,35	17,72	15,35	15,35	15,35	17,72
b ₃	[pulgadas/inch/pouces]	19,29	19,29	21,65	21,65	19,29	21,65	21,65	21,65	13,78	13,78	13,78	15,75	13,78	13,78	13,78	15,75
d	[pulgadas/inch/pouces]	0,94	0,94	1,10	1,10	0,94	1,10	1,10	1,10	0,75	0,75	0,75	0,94	0,75	0,75	0,75	0,94
a ₂	[pulgadas/inch/pouces]	2,95	2,95	2,95	2,95	2,95	2,95	2,95	2,95	2,36	2,36	2,36	2,36	2,36	2,36	2,36	2,36
h	[pulgadas/inch/pouces]	3,15	3,15	3,94	3,94	3,15	3,94	3,94	3,94	2,56	2,56	2,56	3,15	2,56	2,56	2,56	3,15
h ₃	[pulgadas/inch/pouces]	10,24	10,24	11,93	11,93	10,24	11,93	11,93	11,02	7,76	7,76	7,76	8,35	7,76	7,76	7,76	8,35
h ₄	[pulgadas/inch/pouces]	19,76	19,76	22,05	22,05	19,76	22,05	22,05	22,20	13,98	13,98	13,82	15,67	13,98	13,98	13,82	15,67
Tipo de bancada numero Base frame type no. Numéro du type d'armature		6	6	7	7	6	7	7	7	3	3	3	4	3	3	3	4
Peso neto Net weight Poids net	[lbs]	617	650	829	873	650	829	873	931	188	193	212	285	188	193	212	285
Peso bruto Gross weight Poids brut	[lbs]	855	888	1067	1111	888	1067	1111	1162	307	312	331	454	307	312	331	454
Volumen bruto Gross volume Volume brut	[ft ³]	38,10	38,10	38,10	38,10	38,10	38,10	38,10	37	12,92	12,92	12,92	22,70	12,92	12,92	12,92	22,70

P ₂	[HP]	GBS 50-160			GBS 50-200			GBS 50-250			GBS 65-125				
	[kW]	10	15	20	20	25	30	40	40	50	60	5	7,5	10	15
Carcasa/Frame/Armature		215T	254T	256T	256T	284TS	286TS	324TS	324TS	326TS	364TS	184T	184T	215T	254T
ANSI	[psi]	125	125	125	125	125	125	250	250	250	250	125	125	125	125
DN _s	[pulgadas/inch/pouces]	2,50	2,50	2,50	2,50	2,50	2,50	2,50	2,50	2,50	2,50	3,00	3,00	3,00	3,00
DN _d	[pulgadas/inch/pouces]	2,00	2,00	2,00	2,00	2,00	2,00	2,00	2,00	2,00	2,00	2,50	2,50	2,50	2,50
a	[pulgadas/inch/pouces]	3,94	3,94	3,94	3,94	3,94	3,94	3,94	3,94	3,94	3,94	3,94	3,94	3,94	3,94
h ₂	[pulgadas/inch/pouces]	7,09	7,09	7,09	7,87	7,87	7,87	7,87	8,86	8,86	8,86	7,09	7,09	7,09	7,09
L	[pulgadas/inch/pouces]	38,78	42,17	43,82	43,82	46,06	47,56	49,13	49,13	49,13	49,57	34,69	36,65	38,78	42,17
l ₁	[pulgadas/inch/pouces]	39,37	44,09	44,09	44,09	44,09	55,12	55,12	55,12	55,12	55,12	39,37	39,37	44,09	49,21
l ₂	[pulgadas/inch/pouces]	6,69	7,48	7,48	7,48	7,48	9,06	9,06	9,06	9,06	9,06	6,69	6,69	7,48	8,07
l ₃	[pulgadas/inch/pouces]	25,98	29,13	29,13	29,13	29,13	37,01	37,01	37,01	37,01	37,01	25,98	25,98	29,13	33,07
b ₁	[pulgadas/inch/pouces]	13,39	14,96	14,96	14,96	14,96	18,90	18,90	18,90	18,90	18,90	13,39	13,39	14,96	16,93
b ₂	[pulgadas/inch/pouces]	17,72	19,29	19,29	19,29	19,29	24,02	24,02	24,02	24,02	24,02	17,72	17,72	19,29	21,26
b ₃	[pulgadas/inch/pouces]	15,75	17,32	17,32	17,32	17,32	21,65	21,65	21,65	21,65	21,65	15,75	15,75	17,32	19,29
d	[pulgadas/inch/pouces]	0,94	0,94	0,94	0,94	0,94	1,10	1,10	1,10	1,10	1,10	0,94	0,94	0,94	0,94
a ₂	[pulgadas/inch/pouces]	2,36	2,36	2,36	2,36	2,36	2,36	2,36	2,95	2,95	2,95	2,95	2,95	2,95	2,95
h	[pulgadas/inch/pouces]	3,15	3,15	3,15	3,15	3,15	3,94	3,94	3,94	3,94	3,94	3,15	3,15	3,15	3,15
h ₃	[pulgadas/inch/pouces]	9,45	9,45	9,45	9,45	10,16	10,94	11,81	11,81	11,81	12,95	9,45	9,45	9,45	9,45
h ₄	[pulgadas/inch/pouces]	16,77	18,19	18,19	18,19	19,65	20,43	21,93	21,93	21,93	24,13	15,59	15,51	16,77	18,19
Tipo de bancada numero Base frame type no. Numéro du type d'armature		4	5	5	5	5	7	7	7	7	7	4	4	5	6
Peso neto Net weight Poids net	[lbs]	296	380	413	421	581	681	807	834	878	935	226	245	311	398
Peso bruto Gross weight Poids brut	[lbs]	465	549	582	590	750	919	1045	1072	1116	1173	395	414	480	636
Volumen bruto Gross volume Volume brut	[ft ³]	22,70	22,70	22,70	22,70	22,70	38,10	38,10	38,10	38,10	38,10	22,70	22,70	22,70	38,10

Nota: Todas las medidas estan basadas con acoplamiento estandar, las dimensiones cambian con el acoplamiento espaciador.

Note: All dimensions are based on standard coupling, dimensions will change for spacer coupling.

Note: Toutes les dimensions sont fondées sur la norme coupling, les dimensions changeront pour l'entretoise coupling.

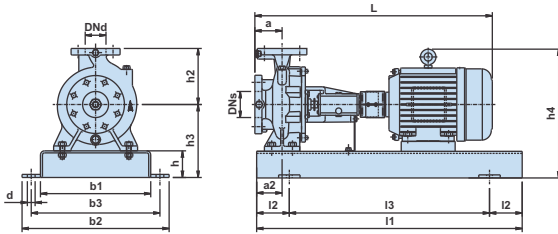

GBS 65-160, GBS 65-160L, GBS 65-200,
GBS 65-250, GBS 80-160

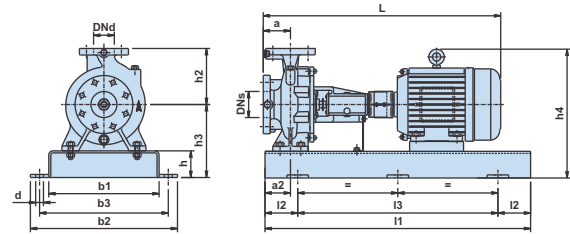

GBS 80-200, GBS-250, GBS 65-250L,
GBS 100-200, GBS 100-250

P ₂	[HP]	GBS 65-160 / GBS 65-160L				GBS 65-200				GBS 65-250				GBS 80-160			
	[kW]	15	20	25	30	40	50	60	75	50	60	75	100	20	25	30	40
Carcasa/Frame/Armature	[psi]	254T	256T	284TS	286TS	324TS	326TS	364TS	365TS	326TS	364TS	365TS	405TS	256T	284TS	286TS	324TS
ANSI	[in/pouces]	125	125	125	125	125	125	125	250	250	250	250	250	125	125	125	125
DN _s	[in/pouces]	3,00	3,00	3,00	3,00	3,00	3,00	3,00	3,00	3,00	3,00	3,00	3,00	4,00	4,00	4,00	4,00
DN _d	[in/pouces]	2,50	2,50	2,50	2,50	2,50	2,50	2,50	2,50	2,50	2,50	2,50	2,50	3,00	3,00	3,00	3,00
a	[in/pouces]	3,94	3,94	3,94	3,94	3,94	3,94	3,94	3,94	3,94	3,94	3,94	3,94	4,92	4,92	4,92	4,92
h ₂	[in/pouces]	7,87	7,87	7,87	7,87	8,86	8,86	8,86	8,86	9,84	9,84	9,84	9,84	8,86	8,86	8,86	8,86
L	[in/pouces]	42,17	43,82	46,06	47,56	49,13	49,13	49,61	50,89	53,46	53,94	50,89	58,11	44,80	47,05	48,54	50,12
i ₁	[in/pouces]	44,09	44,09	44,09	44,09	55,12	55,12	55,12	55,12	55,12	55,12	55,12	55,12	49,21	49,21	49,21	49,21
i ₂	[in/pouces]	7,48	7,48	7,48	7,48	9,06	9,06	9,06	9,06	9,06	9,06	9,06	9,06	8,07	8,07	8,07	8,07
i ₃	[in/pouces]	29,13	29,13	29,13	29,13	37,01	37,01	37,01	37,01	37,01	37,01	37,01	37,01	33,07	33,07	33,07	33,07
b ₁	[in/pouces]	14,96	14,96	14,96	14,96	18,90	18,90	18,90	18,90	18,90	18,90	18,90	18,90	16,93	16,93	16,93	16,93
b ₂	[in/pouces]	19,29	19,29	19,29	19,29	24,02	24,02	24,02	24,02	24,02	24,02	24,02	24,02	21,26	21,26	21,26	21,26
b ₃	[in/pouces]	17,32	17,32	17,32	17,32	21,65	21,65	21,65	21,65	21,65	21,65	21,65	21,65	19,29	19,29	19,29	19,29
d	[in/pouces]	0,94	0,94	0,94	0,94	1,10	1,10	1,10	1,10	1,10	1,10	1,10	1,10	0,94	0,94	0,94	0,94
a ₂	[in/pouces]	2,95	2,95	2,95	2,95	2,95	2,95	2,95	2,95	3,54	2,95	2,95	2,95	2,95	2,95	2,95	2,95
h	[in/pouces]	3,15	3,15	3,15	3,15	3,94	3,94	3,94	3,94	3,94	3,94	3,94	3,94	3,15	3,15	3,15	3,15
h ₃	[in/pouces]	9,45	9,45	10,16	10,24	11,81	11,81	12,95	12,80	11,81	12,95	12,80	13,78	10,24	10,24	10,24	11,02
h ₄	[in/pouces]	18,19	18,19	19,65	19,76	21,93	21,93	24,13	23,98	21,93	24,13	23,98	26,26	18,98	19,76	19,76	21,14
Tipo de bancada numero Base frame type no. Numéro du type d'armature		5	5	5	5	7	7	7	7	7	7	7	7	6	6	6	6
Peso neto Net weight Poids net	[lbs]	397	430	590	623	832	876	933	1047	928	986	1100	1493	1100	1493	1736	1903
Peso bruto Gross weight Poids brut	[lbs]	566	599	759	792	1070	1114	1041	1285	1166	1224	1338	1731	1338	1731	1974	2141
Volumen bruto Gross volume Volume brut	[ft ³]	22,70	22,70	22,70	22,70	38,10	38,10	38,10	38,10	38,10	38,10	38,10	38,10	38,10	38,10	38,10	38,10

P ₂	[HP]	GBS 80-200				GBS 80-250				GBS 65-250L				GBS 100-200				GBS 100-250			
	[kW]	50	60	75	100	100	125	150	200	75	100	125	150	60	75	100	125	100	125	150	200
Carcasa/Frame/Armature	[psi]	326TS	364TS	365TS	405TS	405TS	444TS	445TS	505TS	365TS	405TS	444TS	445TS	364TS	365TS	405TS	444TS	405TS	444TS	445TS	505TS
ANSI	[in/pouces]	125	125	125	250	250	250	250	250	250	250	250	250	125	125	125	125	250	250	250	250
DN _s	[in/pouces]	4,00	4,00	4,00	4,00	4,00	4,00	4,00	4,00	4,00	4,00	4,00	4,00	5,00	5,00	5,00	5,00	5,00	5,00	5,00	5,00
DN _d	[in/pouces]	3,00	3,00	3,00	3,00	3,00	3,00	3,00	3,00	2,50	2,50	2,50	2,50	4,00	4,00	4,00	4,00	4,00	4,00	4,00	4,00
a	[in/pouces]	4,92	4,92	4,92	4,92	4,92	4,92	4,92	4,92	3,94	3,94	3,94	3,94	4,92	4,92	4,92	4,92	5,51	5,51	5,51	5,51
h ₂	[in/pouces]	9,84	9,84	9,84	9,84	11,02	11,02	11,02	11,02	9,84	9,84	9,84	9,84	11,02	11,02	11,02	11,02	11,02	11,02	11,02	11,02
L	[in/pouces]	54,41	54,88	55,87	59,06	59,09	62,68	62,68	68,27	54,92	58,11	61,69	61,69	54,88	55,87	59,09	62,64	56,69	63,23	63,23	68,86
i ₁	[in/pouces]	55,12	55,12	55,12	62,99	62,99	70,87	70,87	70,87	55,12	62,99	70,87	70,87	55,12	55,12	62,99	62,99	62,99	70,87	70,87	70,87
i ₂	[in/pouces]	9,06	9,06	9,06	10,63	10,63	11,81	11,81	11,81	9,06	10,63	11,81	11,81	9,06	9,06	10,63	10,63	10,63	11,81	11,81	11,81
i ₃	[in/pouces]	37,01	37,01	37,01	41,73	41,73	47,24	47,24	47,24	37,01	41,73	47,24	47,24	37,01	37,01	41,73	41,73	41,73	47,24	47,24	47,24
b ₁	[in/pouces]	18,90	18,90	18,90	20,87	20,87	23,62	23,62	23,62	18,90	20,87	23,62	23,62	18,90	18,90	20,87	20,87	20,87	23,62	23,62	23,62
b ₂	[in/pouces]	24,02	24,02	24,02	25,98	25,98	28,74	28,74	28,74	24,02	25,98	28,74	28,74	24,02	24,02	25,98	25,98	25,98	28,74	28,74	28,74
b ₃	[in/pouces]	21,65	21,65	21,65	23,62	23,62	26,38	26,38	26,38	21,65	23,62	26,38	26,38	21,65	21,65	23,62	23,62	23,62	26,38	26,38	26,38
d	[in/pouces]	1,10	1,10	1,10	1,10	1,10	1,10	1,10	1,10	1,10	1,10	1,10	1,10	1,10	1,10	1,10	1,10	1,10	1,10	1,10	1,10
a ₂	[in/pouces]	2,95	2,95	2,95	2,95	3,54	3,54	3,54	3,54	3,54	3,54	3,54	3,54	3,54	3,54	3,54	3,54	3,54	3,54	3,54	3,54
h	[in/pouces]	3,94	3,94	3,94	3,94	3,94	3,94	3,94	3,94	3,94	3,94	3,94	3,94	3,94	3,94	3,94	3,94	3,94	3,94	3,94	3,94
h ₃	[in/pouces]	12,95	12,95	12,80	13,78	13,78	14,96	14,96	16,46	12,08	13,78	14,96	14,96	12,95	12,95	13,94	14,96	13,94	14,96	14,96	16,46
h ₄	[in/pouces]	21,93	24,13	23,98	26,26	26,26	28,90	28,90	34,21	23,98	26,26	28,94	28,94	24,13	24,13	26,42	28,94	26,42	28,94	28,94	34,21
Tipo de bancada numero Base frame type no. Numéro du type d'armature		7	7	7	8	8	9	9	9	7	8	9	9	7	7	8	8	8	9	9	9
Peso neto Net weight Poids net	[lbs]	911	968	1082	1475	1506	1749	1916	2431	1100	1506	1749	1916	992	1107	1499	1705	1524	1767	1934	2449
Peso bruto Gross weight Poids brut	[lbs]	1149	1206	1320	1768	1799	2101	2268	2783	1338	1799	2101	2268	1230	1345	1792	1998	1817	2119	2286	2801
Volumen bruto Gross volume Volume brut	[ft ³]	38,10	38,10	38,10	52,05	52,05	68,78	68,78	68,78	38,10	52,05	68,78	68,78	38,10	38,10	52,05	52,05	52,05	68,78	68,78	68,78

Nota: Todas las medidas estan basadas con acoplamiento estandar, las dimensiones cambian con el acoplamiento espaciador.

Note: All dimensions are based on standard coupling, dimensions will change for spacer coupling.

Note: Toutes les dimensions sont fondées sur la norme coupling, les dimensions changeront pour l'entretoise coupling.

GBS 32-160

Curvas Características
Characteristic Curves
Courbes Caractéristiques

1750

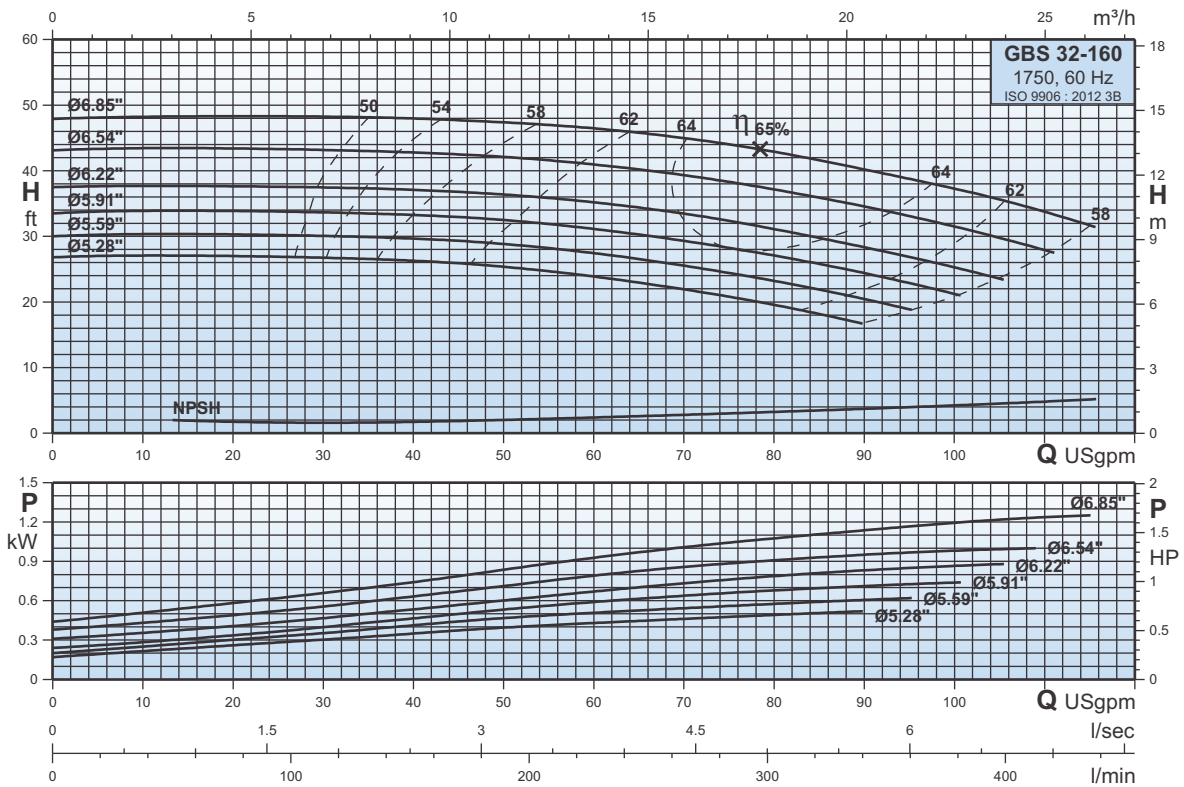

GBS 32-200

Curvas Características
Characteristic Curves
Courbes Caractéristiques

1750

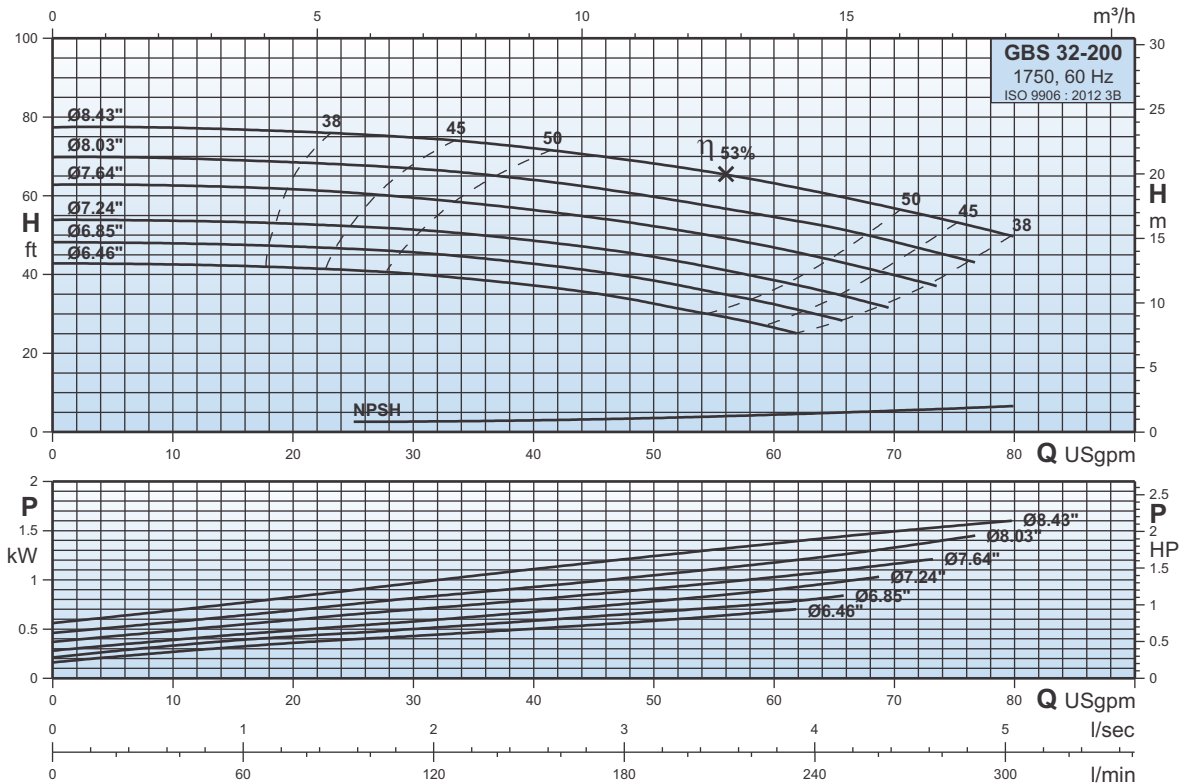

GBS 32-200L

Curvas Características
Characteristic Curves
Courbes Caractéristiques

1750

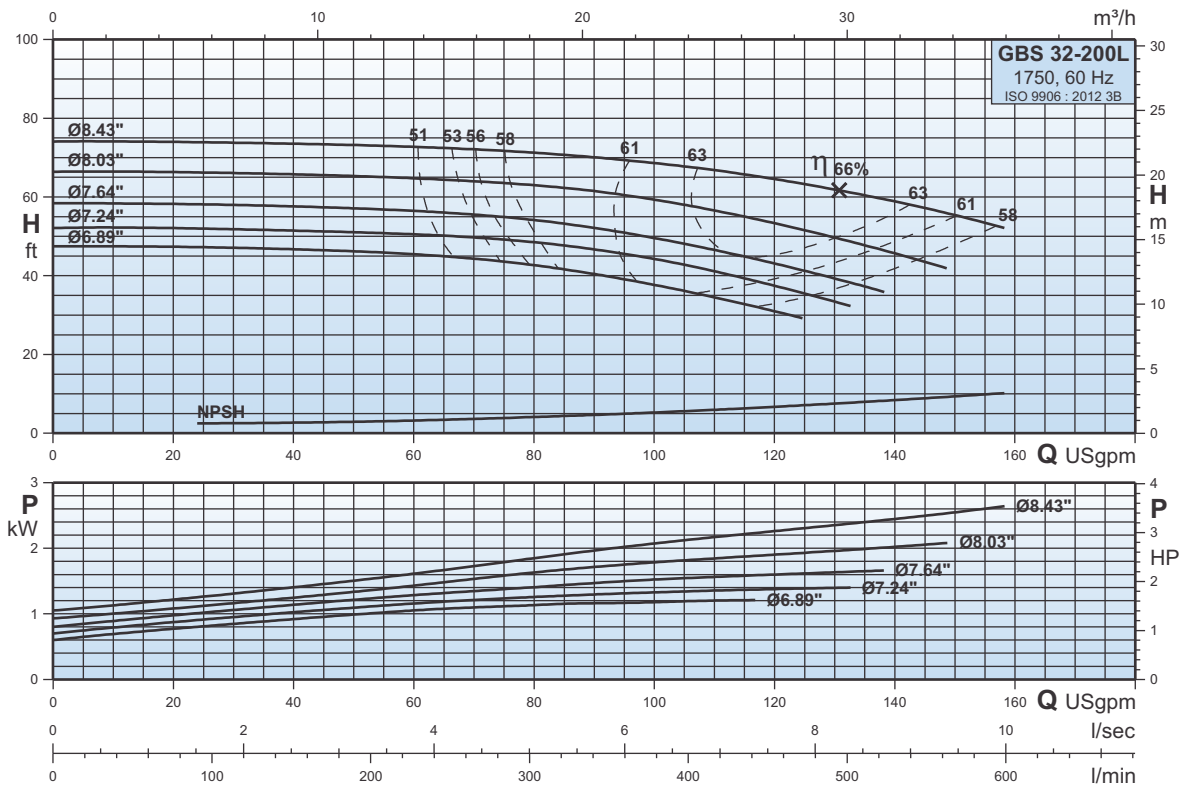

GBS 32-250

Curvas Características
Characteristic Curves
Courbes Caractéristiques

1750

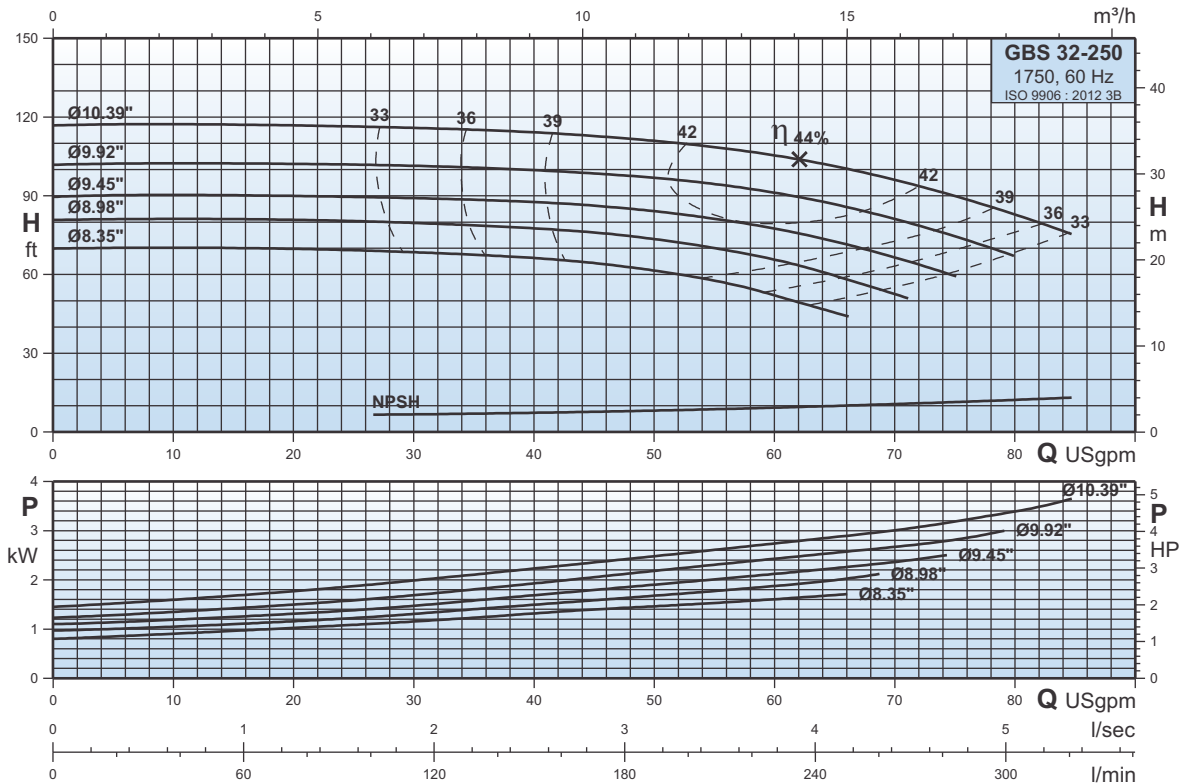

GBS 40-125

Curvas Características
Characteristic Curves
Courbes Caractéristiques

1750

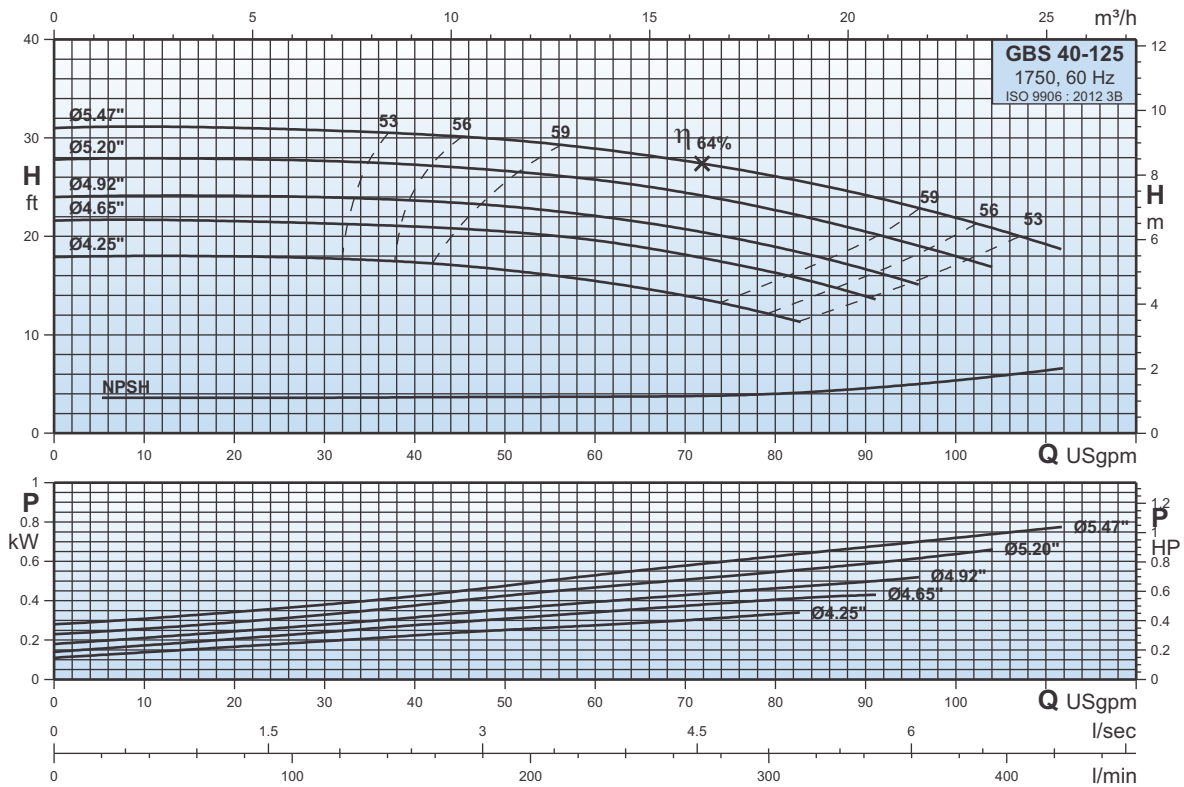

GBS 40-125L

Curvas Características
Characteristic Curves
Courbes Caractéristiques

1750

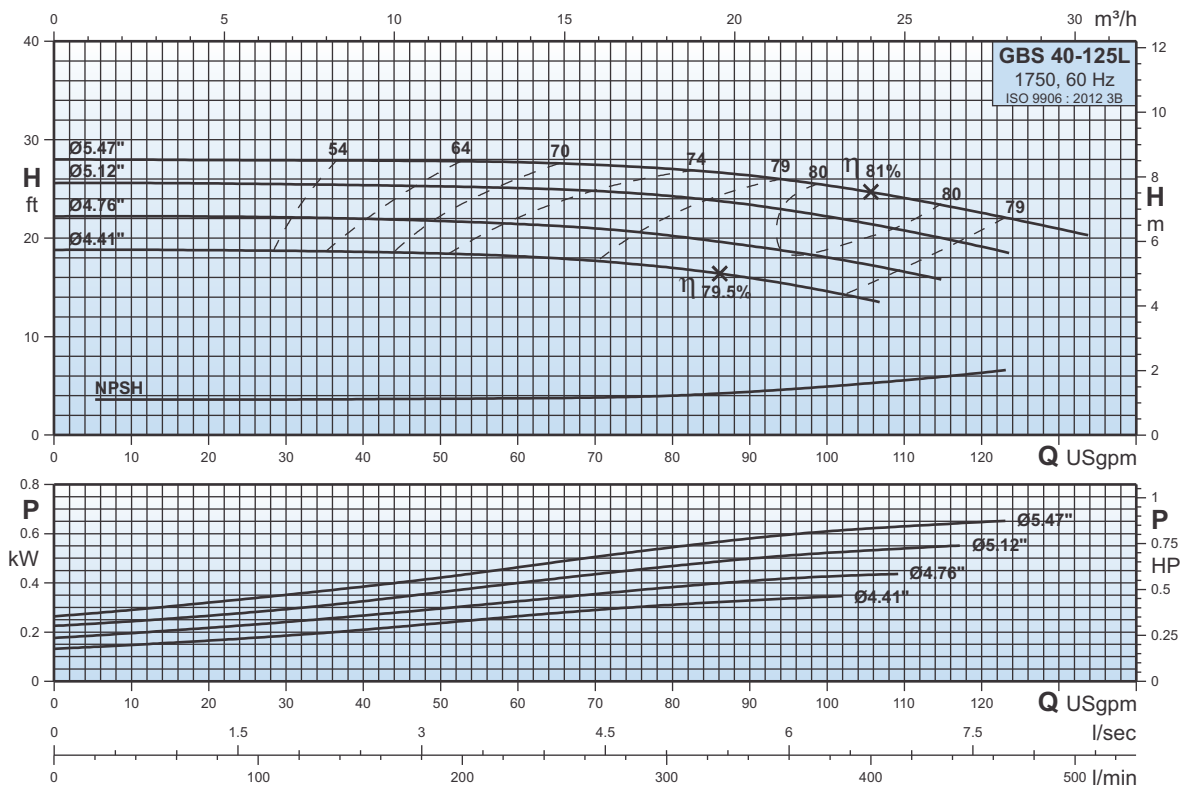

GBS 40-160

Curvas Características
Characteristic Curves
Courbes Caractéristiques

1750

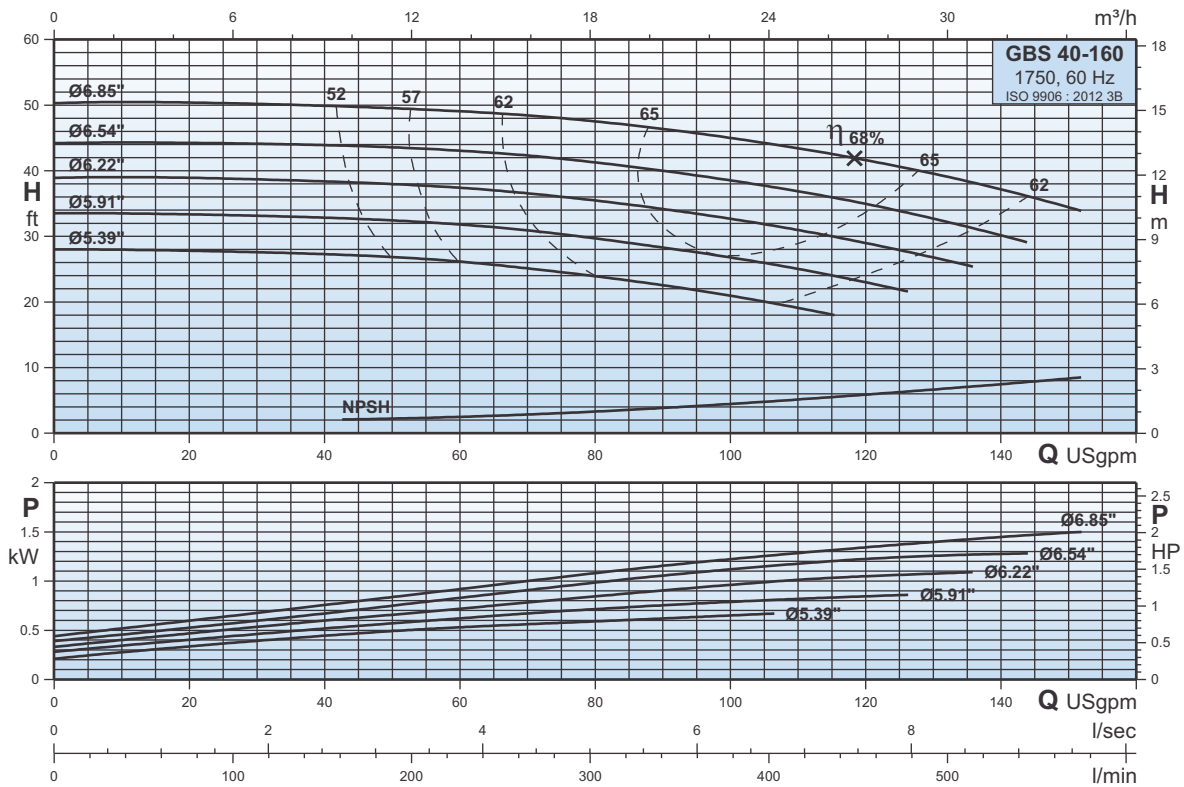

GBS 40-200

Curvas Características
Characteristic Curves
Courbes Caractéristiques

1750

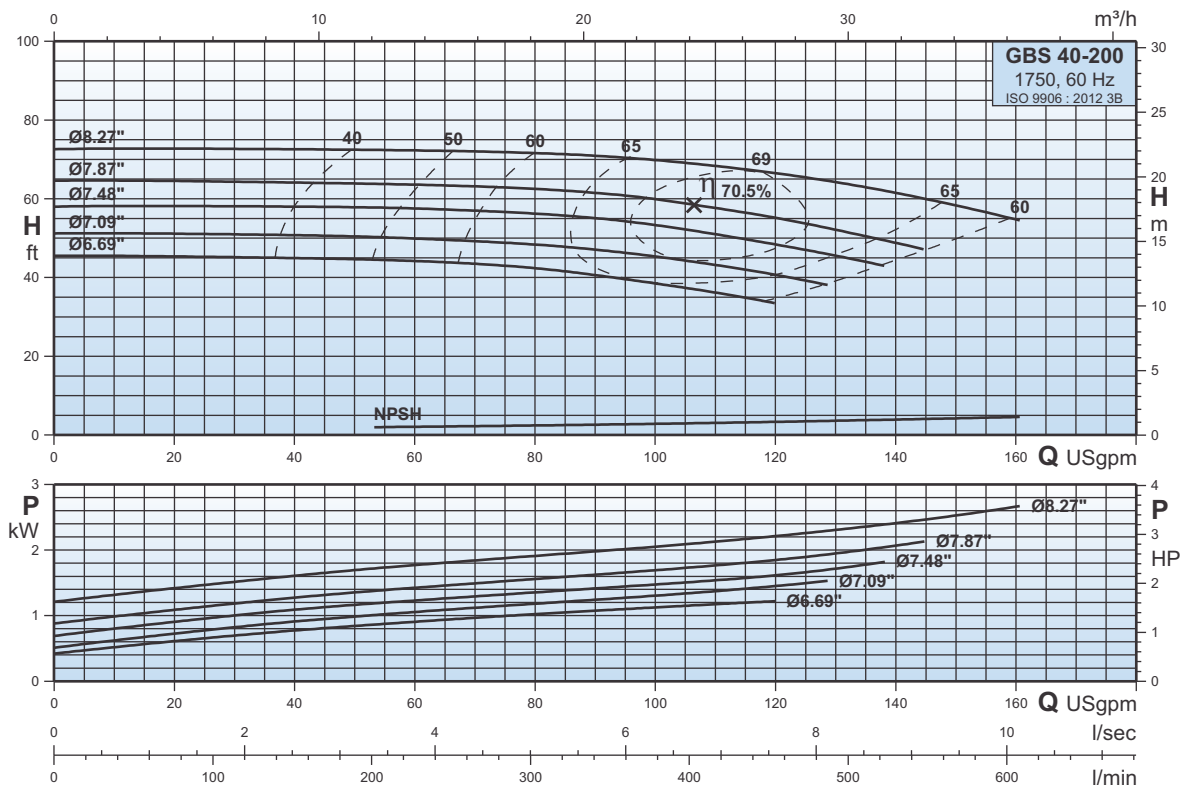

GBS 40-250

Curvas Características
Characteristic Curves
Courbes Caractéristiques

1750

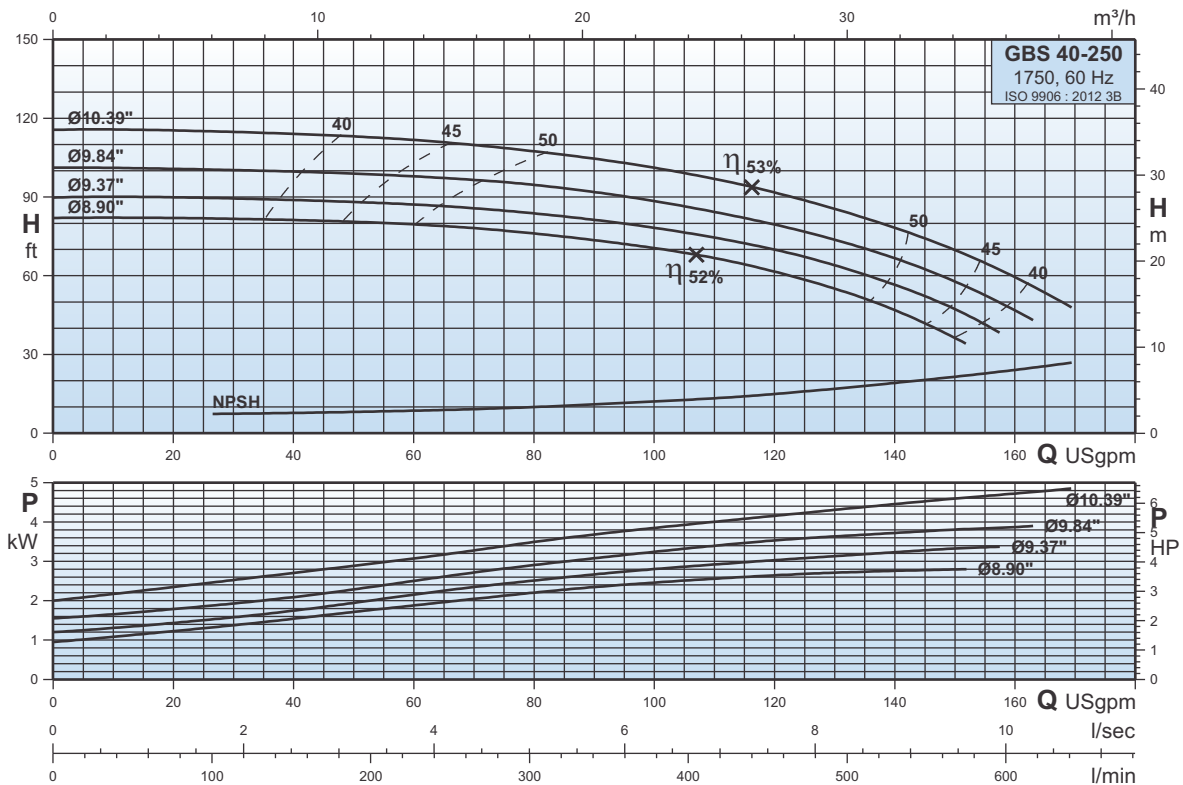

GBS 40-250L

Curvas Características
Characteristic Curves
Courbes Caractéristiques

1750

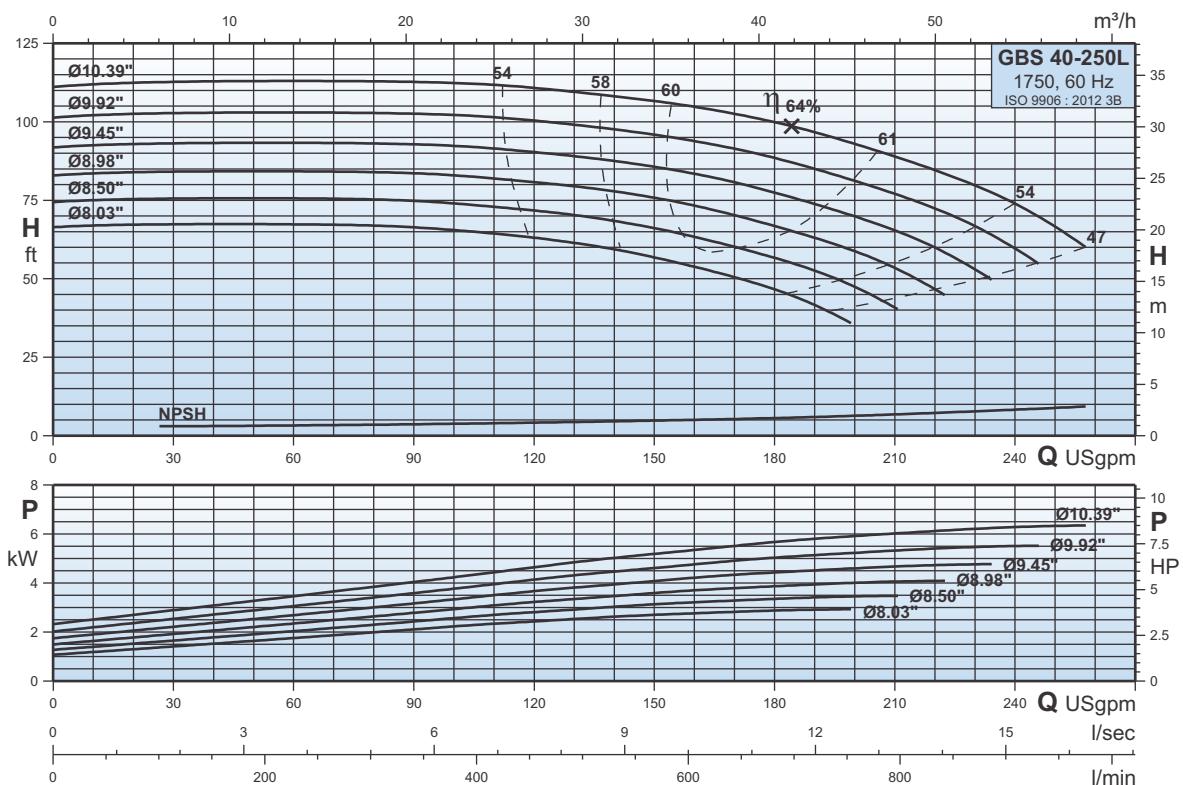

GBS 50-125

Curvas Características
Characteristic Curves
Courbes Caractéristiques

1750

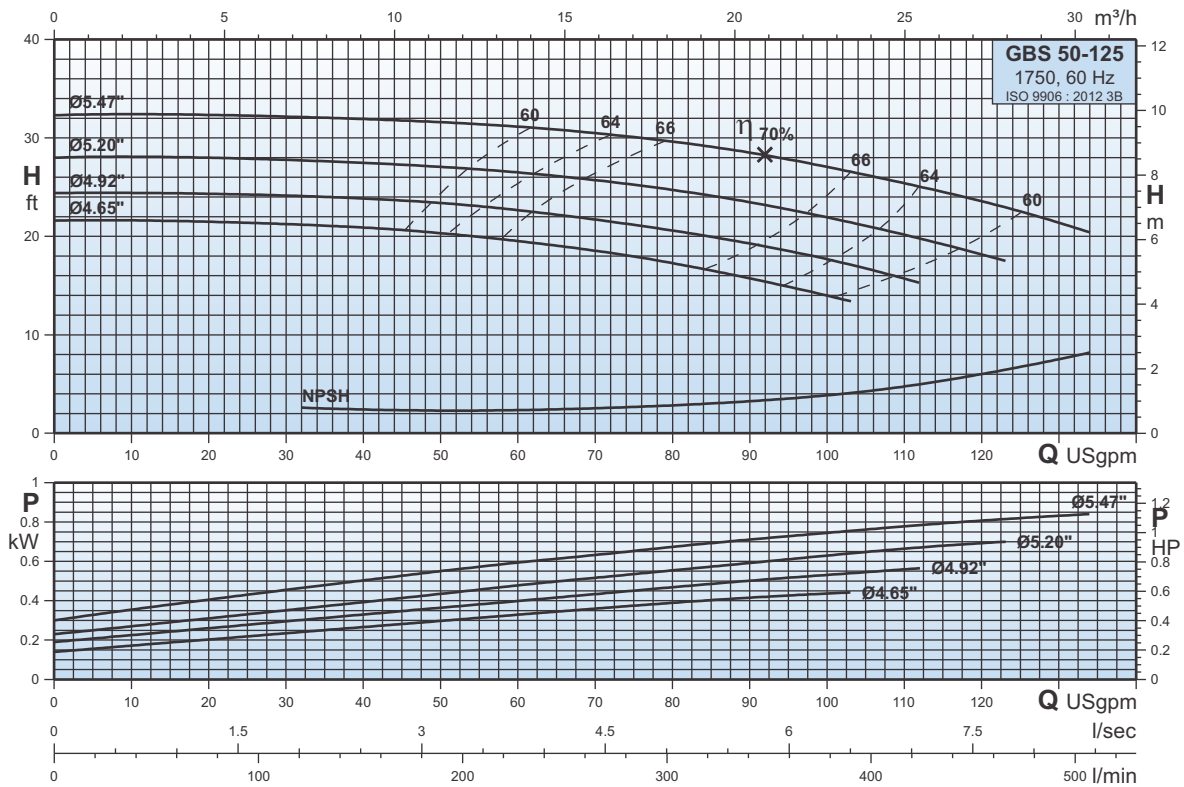

GBS 50-125L

Curvas Características
Characteristic Curves
Courbes Caractéristiques

1750

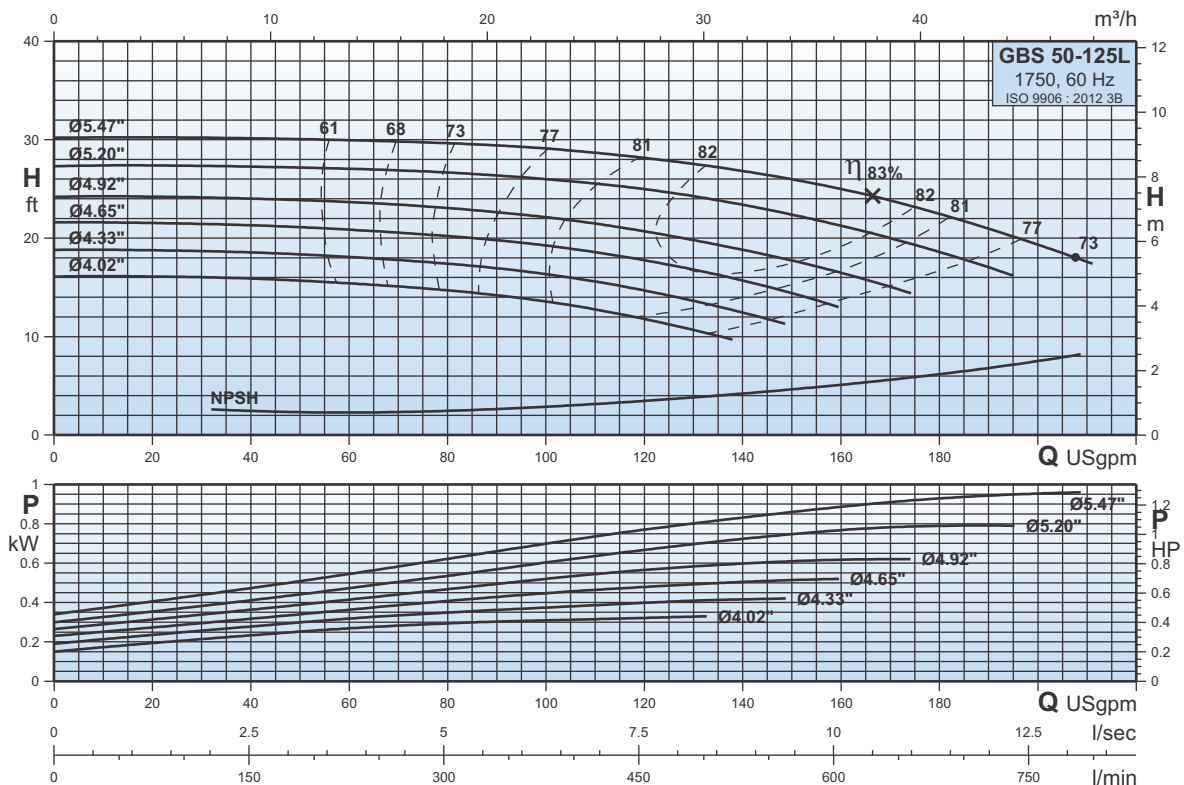

GBS 50-160

Curvas Características
Characteristic Curves
Courbes Caractéristiques

1750

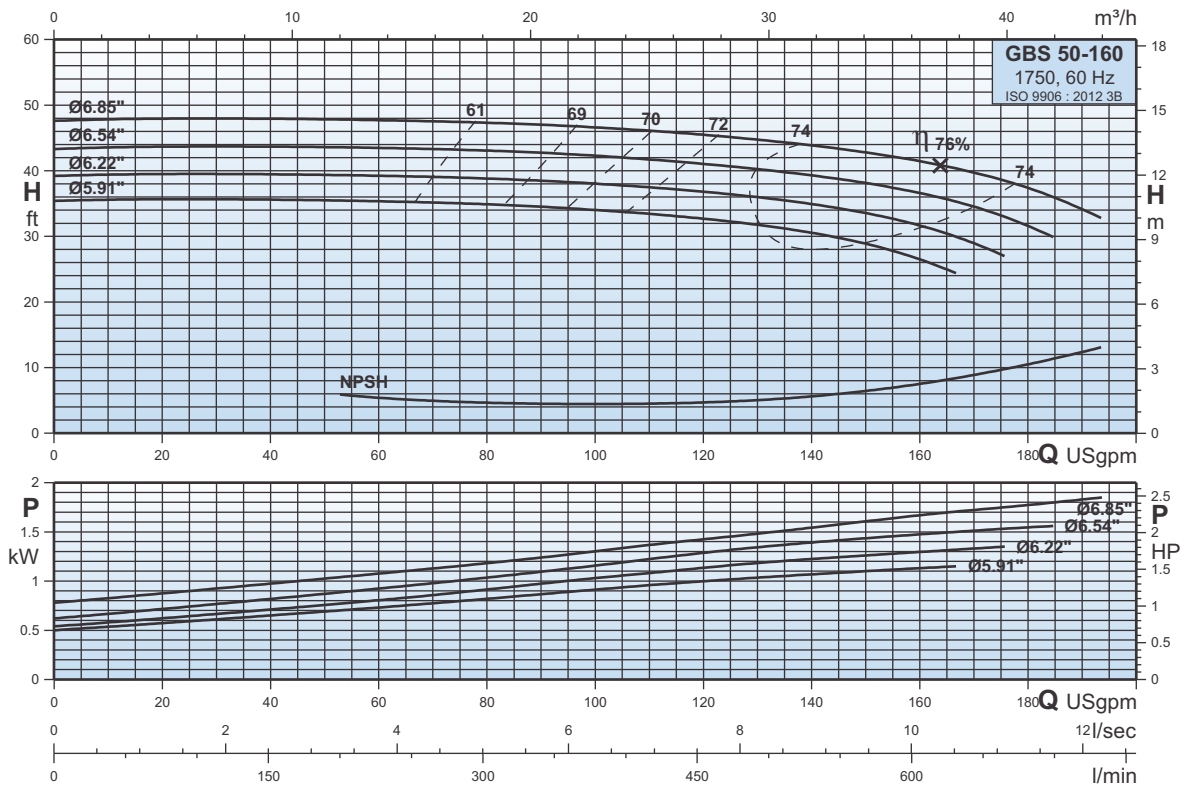

GBS 50-200

Curvas Características
Characteristic Curves
Courbes Caractéristiques

1750

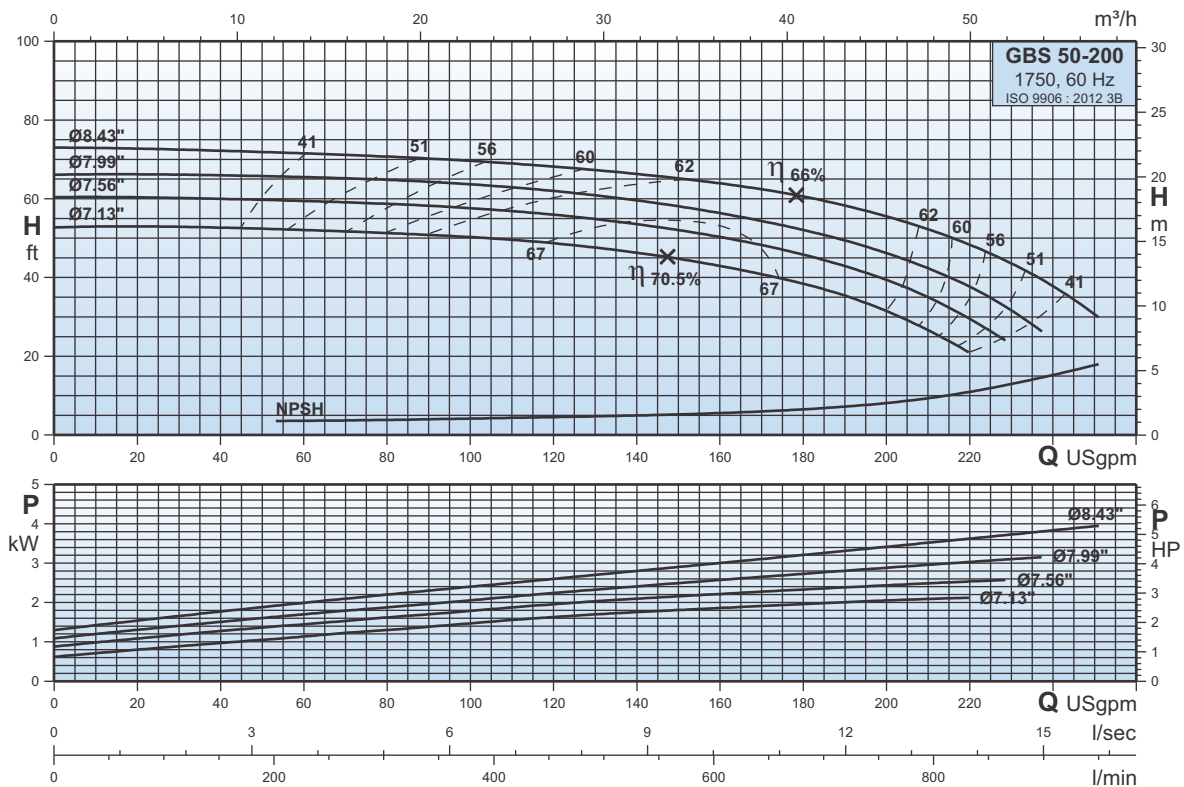

GBS 50-250

Curvas Características
Characteristic Curves
Courbes Caractéristiques

1750

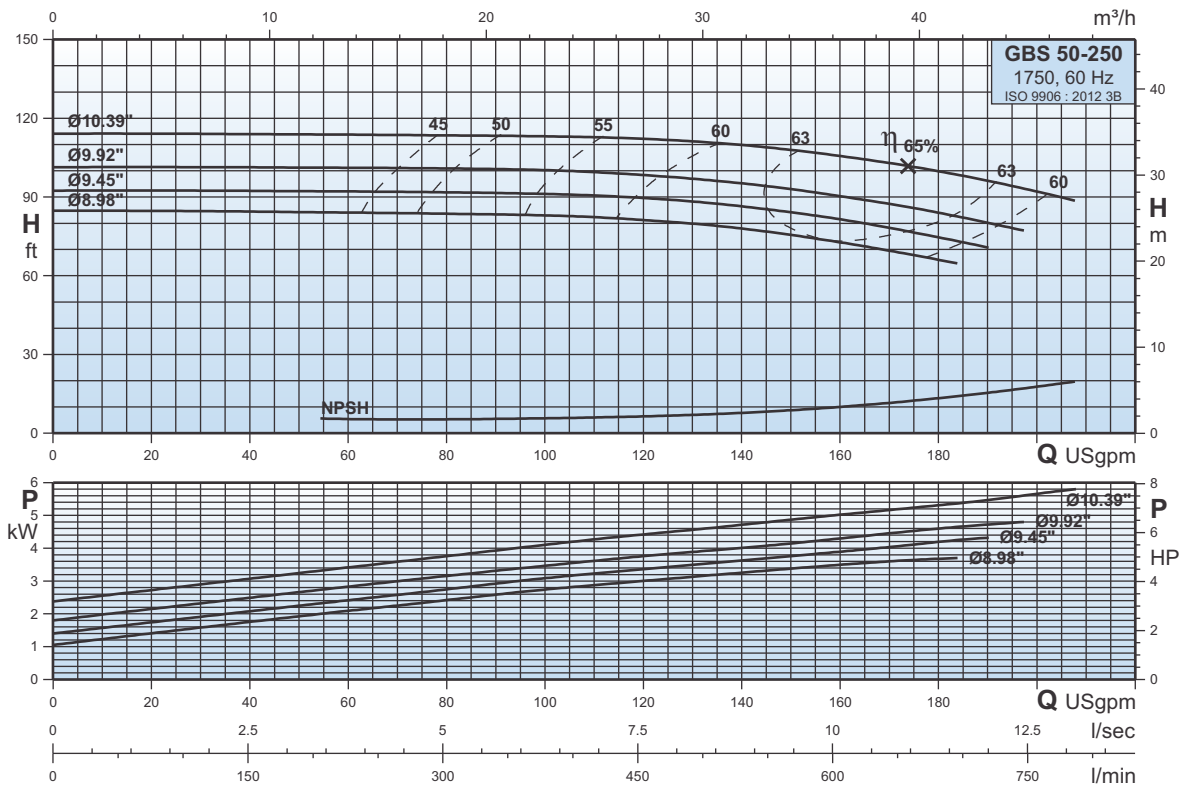

GBS 65-125

Curvas Características
Characteristic Curves
Courbes Caractéristiques

1750

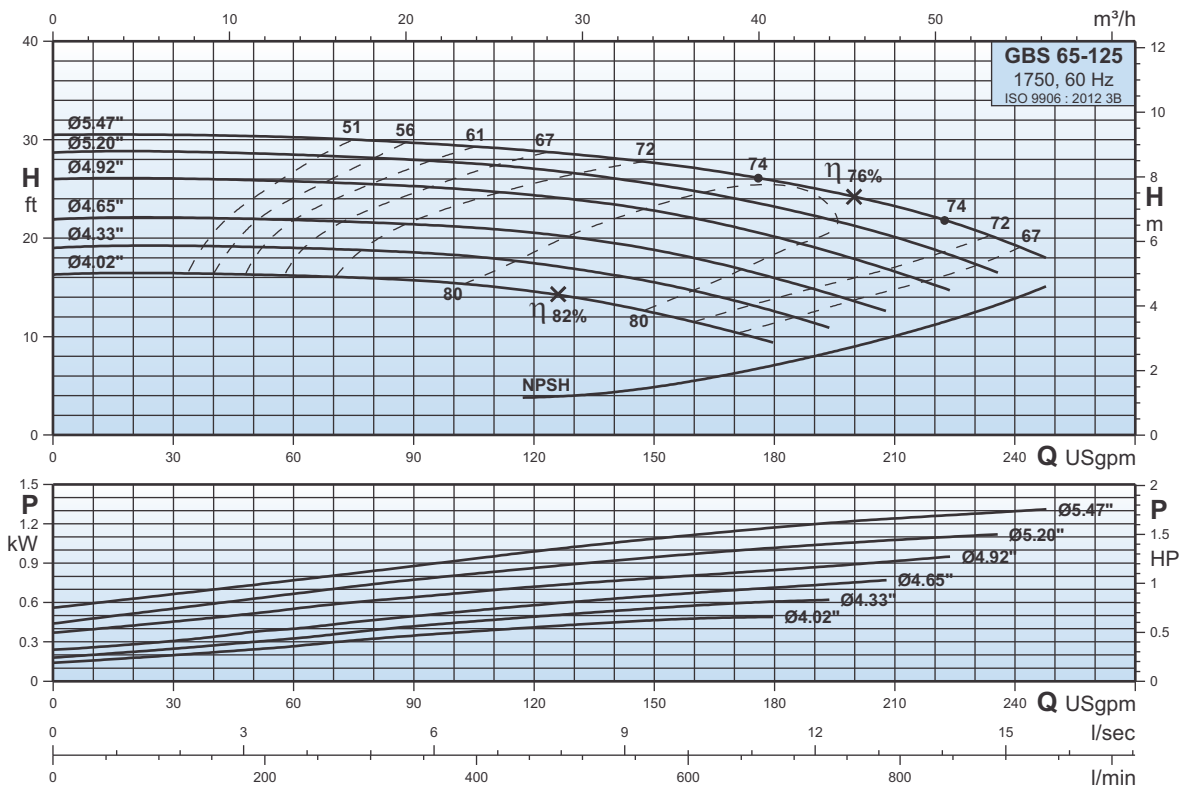

GBS 65-160

Curvas Características
Characteristic Curves
Courbes Caractéristiques

1750

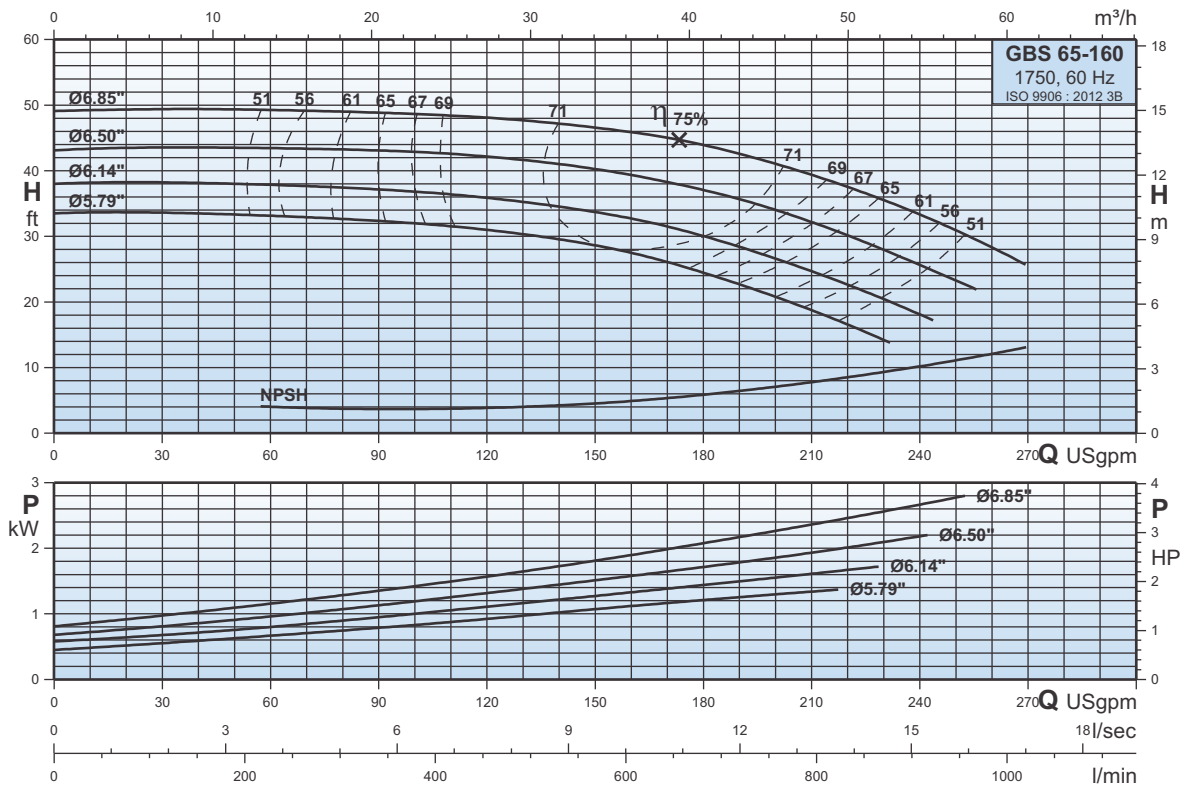

GBS 65-160L

Curvas Características
Characteristic Curves
Courbes Caractéristiques

1750

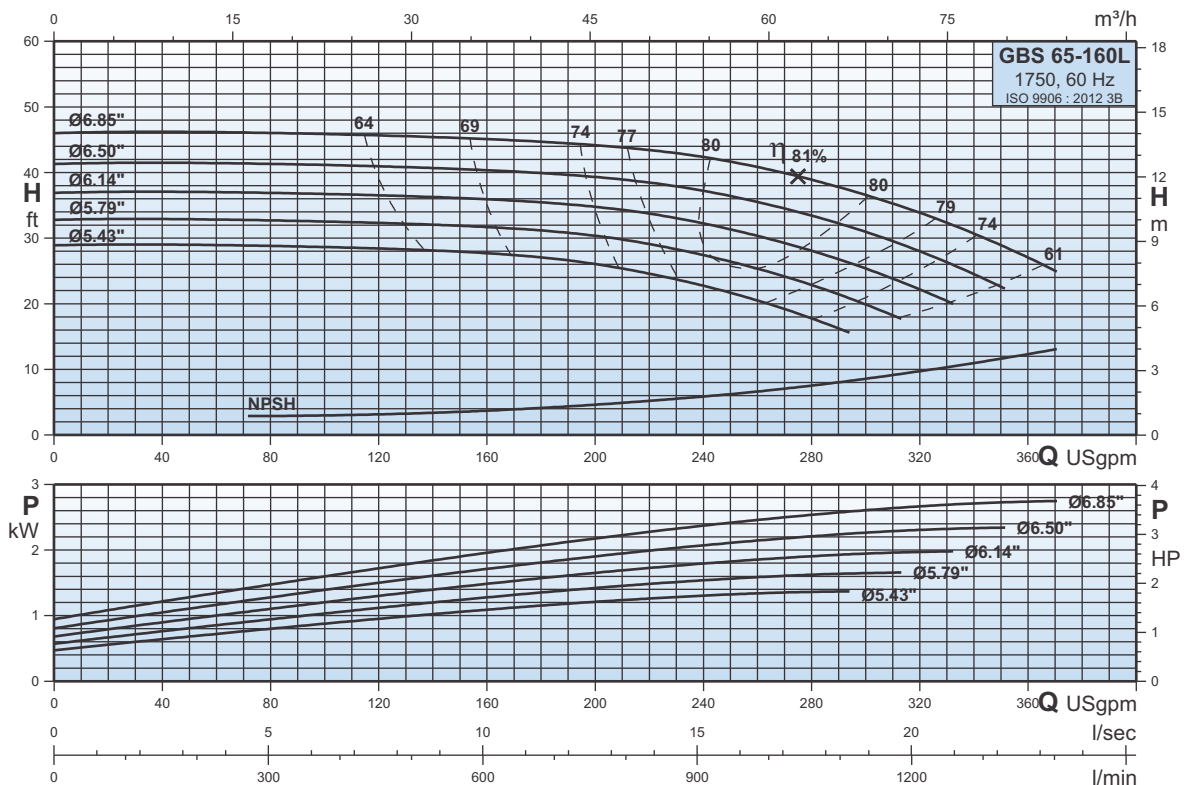

GBS 65-200

Curvas Características
Characteristic Curves
Courbes Caractéristiques

1750

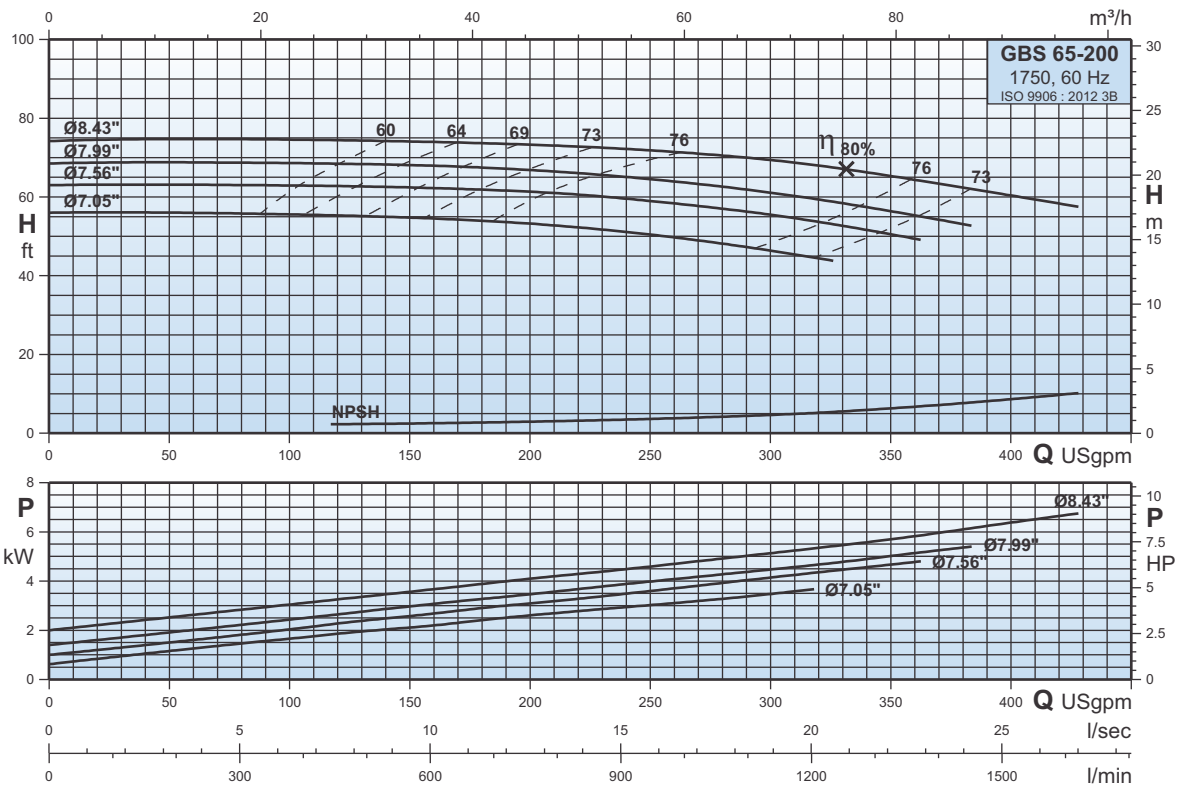

GBS 65-250

Curvas Características
Characteristic Curves
Courbes Caractéristiques

1750

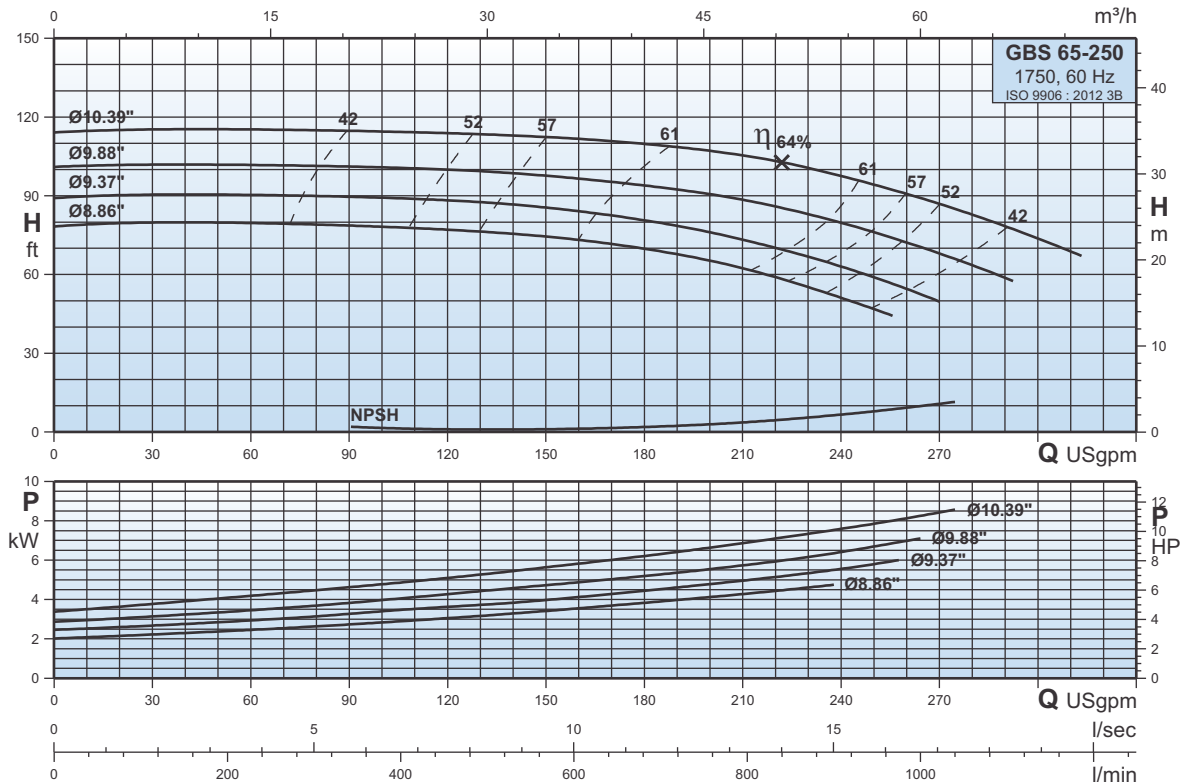

GBS 65-315

Curvas Características
Characteristic Curves
Courbes Caractéristiques

1750

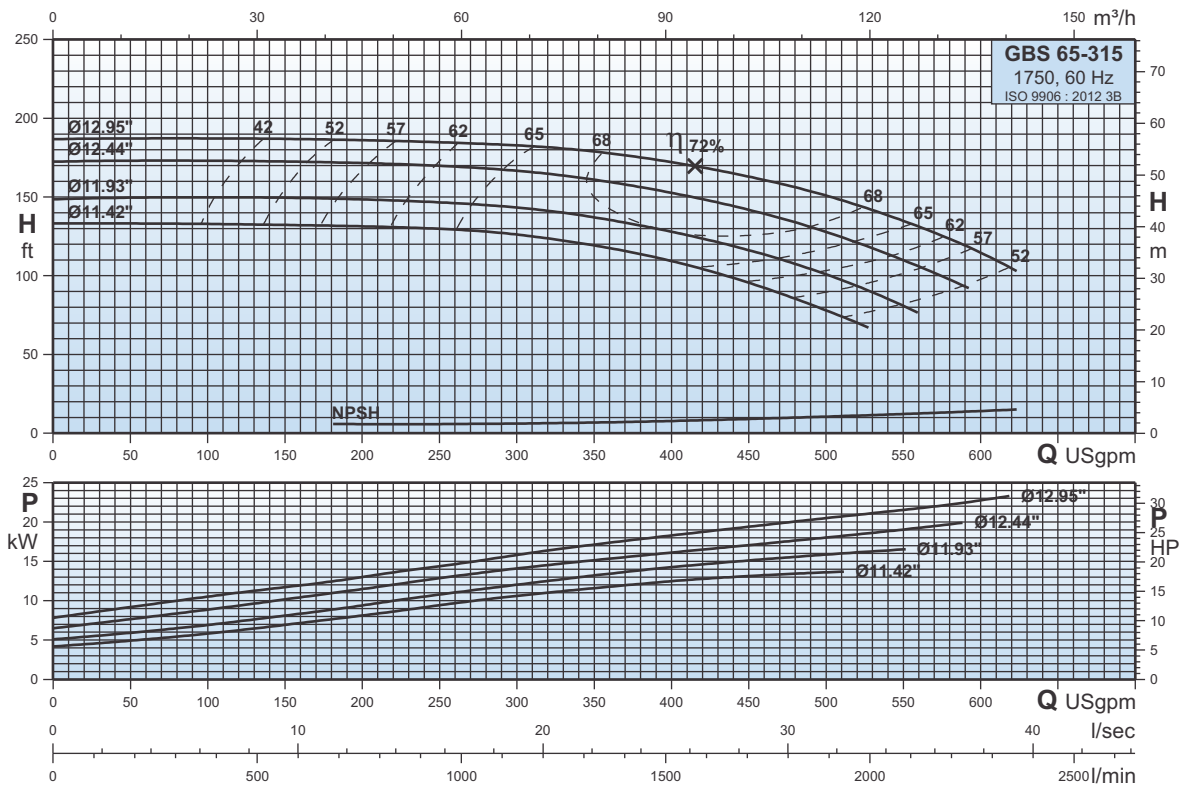

GBS 80-160

Curvas Características
Characteristic Curves
Courbes Caractéristiques

1750

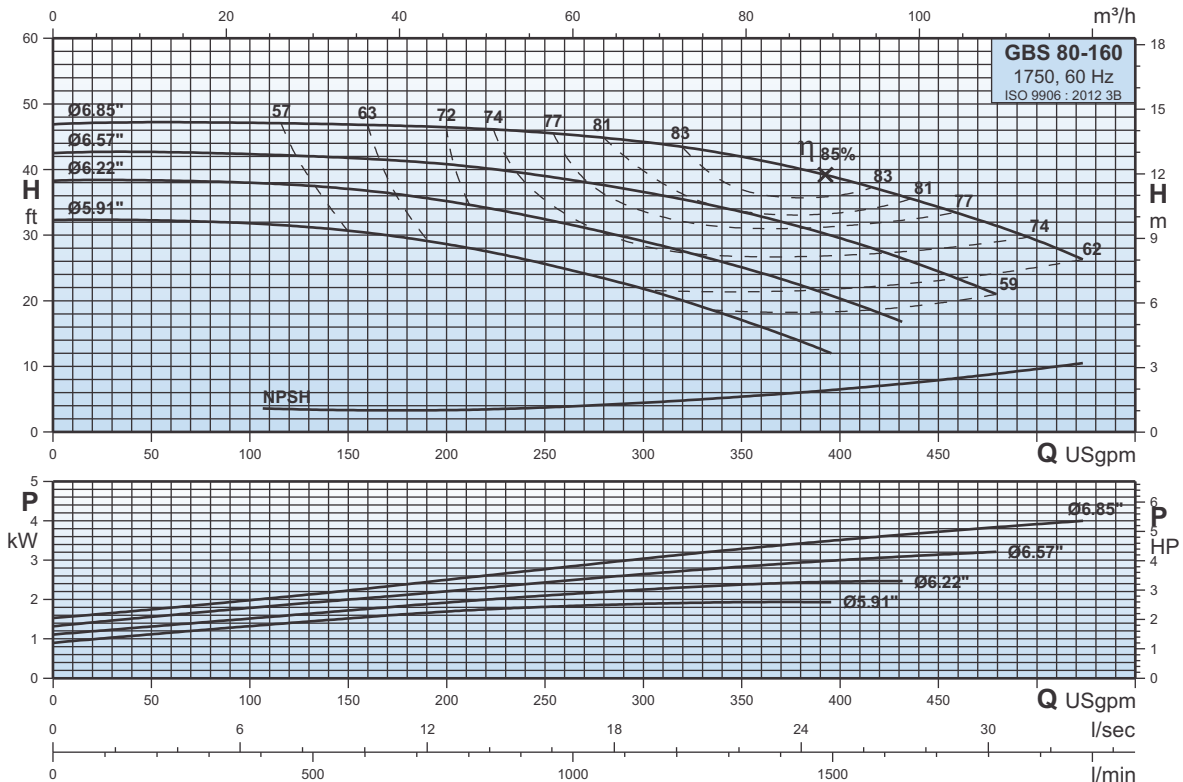

GBS 80-200

Curvas Características
Characteristic Curves
Courbes Caractéristiques

1750

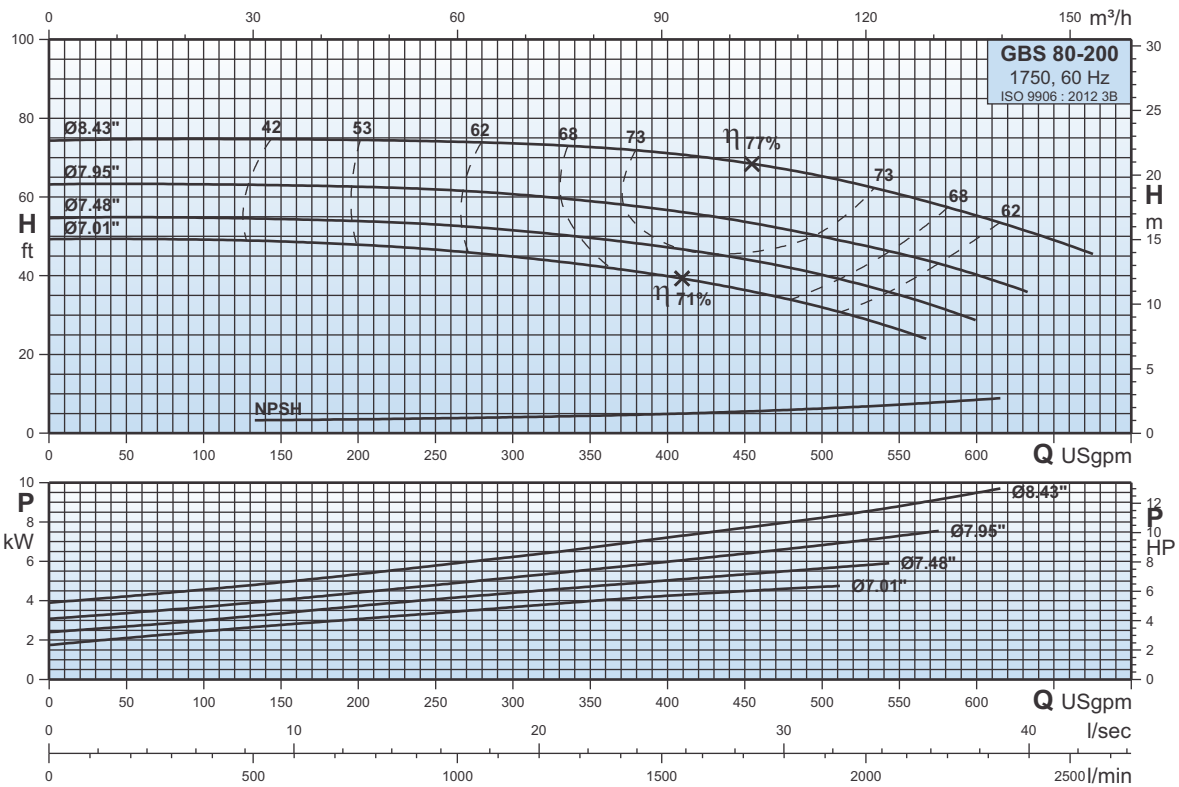

GBS 80-250

Curvas Características
Characteristic Curves
Courbes Caractéristiques

1750

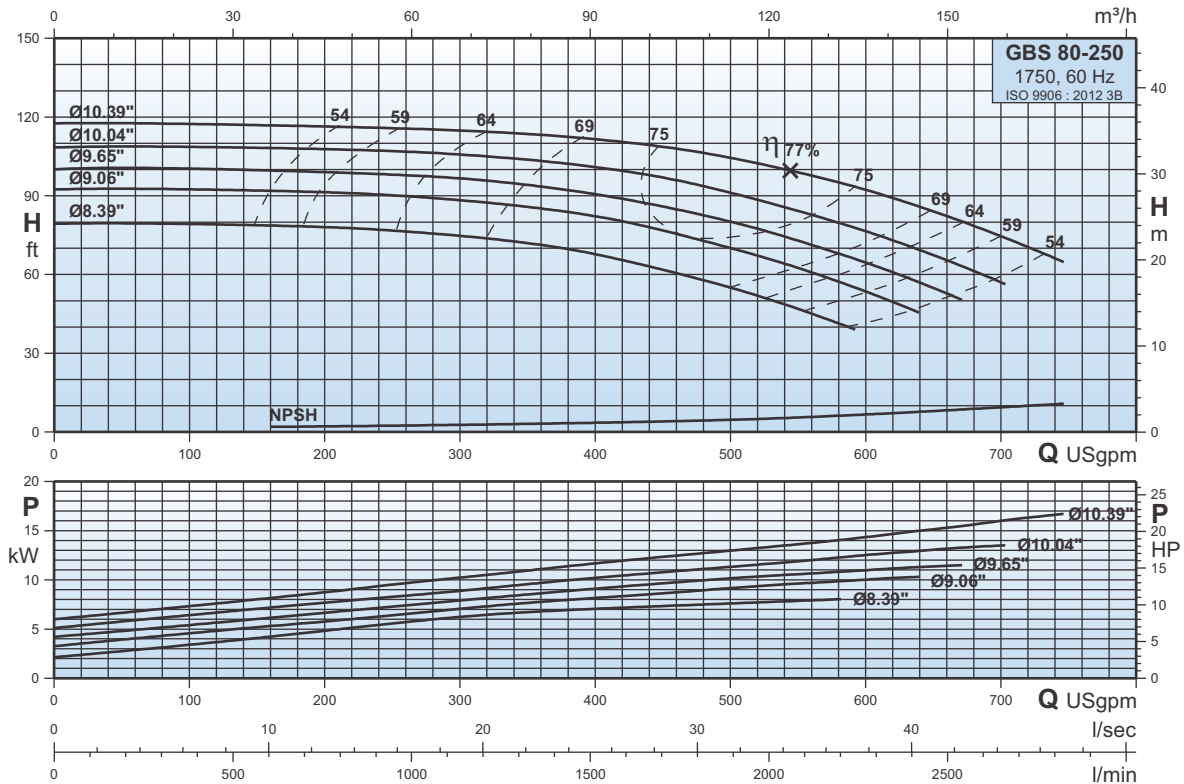

GBS 65-250L

Curvas Características
Characteristic Curves
Courbes Caractéristiques

1750

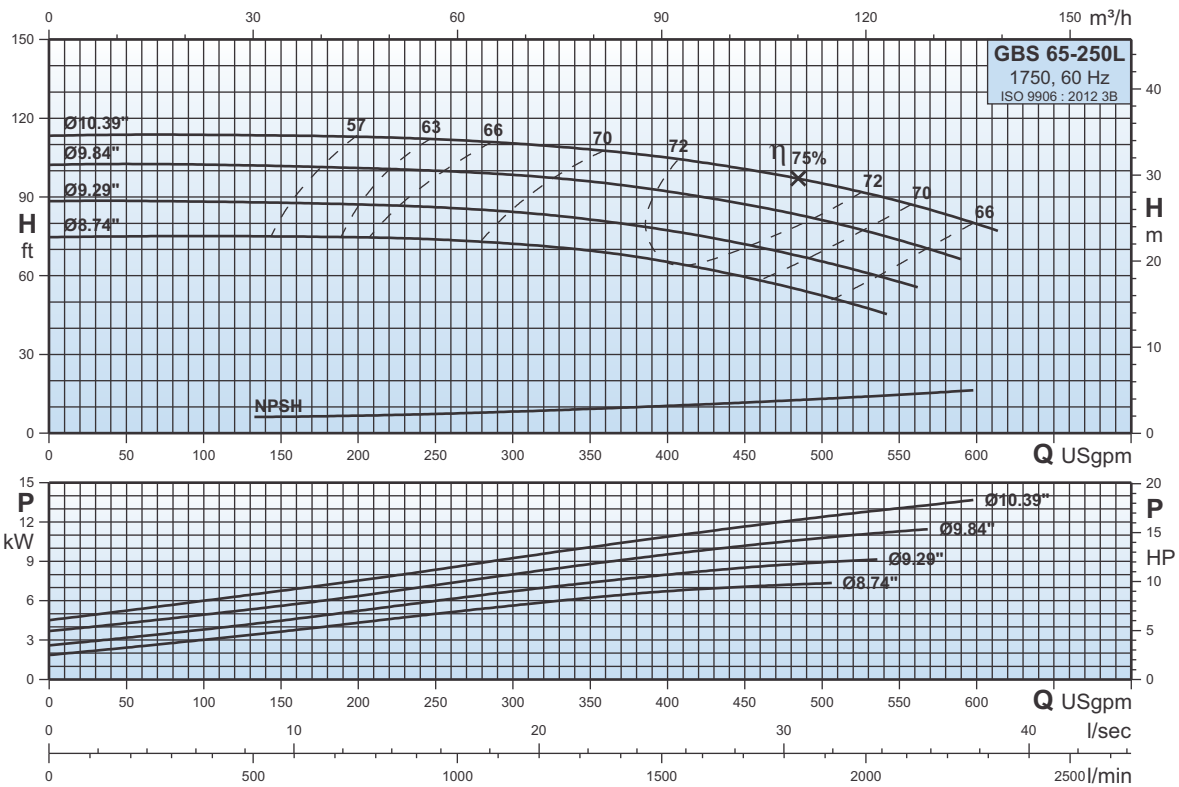

GBS 80-315

Curvas Características
Characteristic Curves
Courbes Caractéristiques

1750

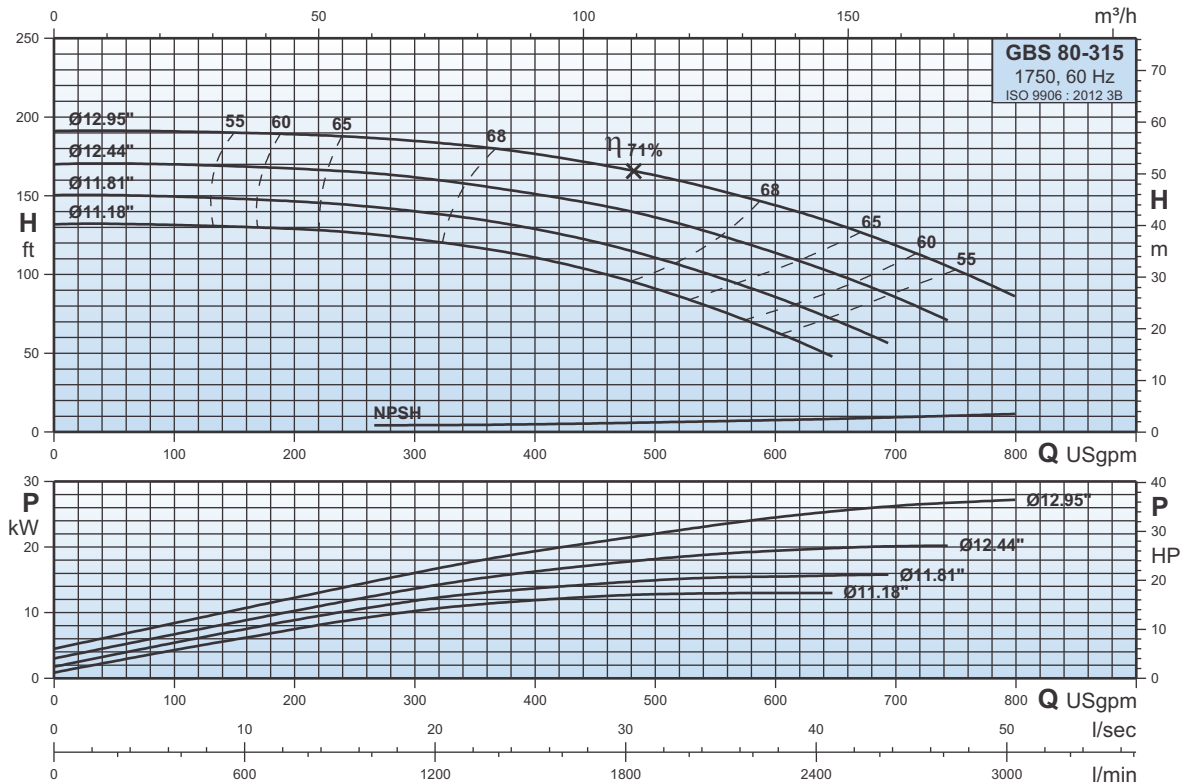

GBS 80-400

Curvas Características
Characteristic Curves
Courbes Caractéristiques

1750

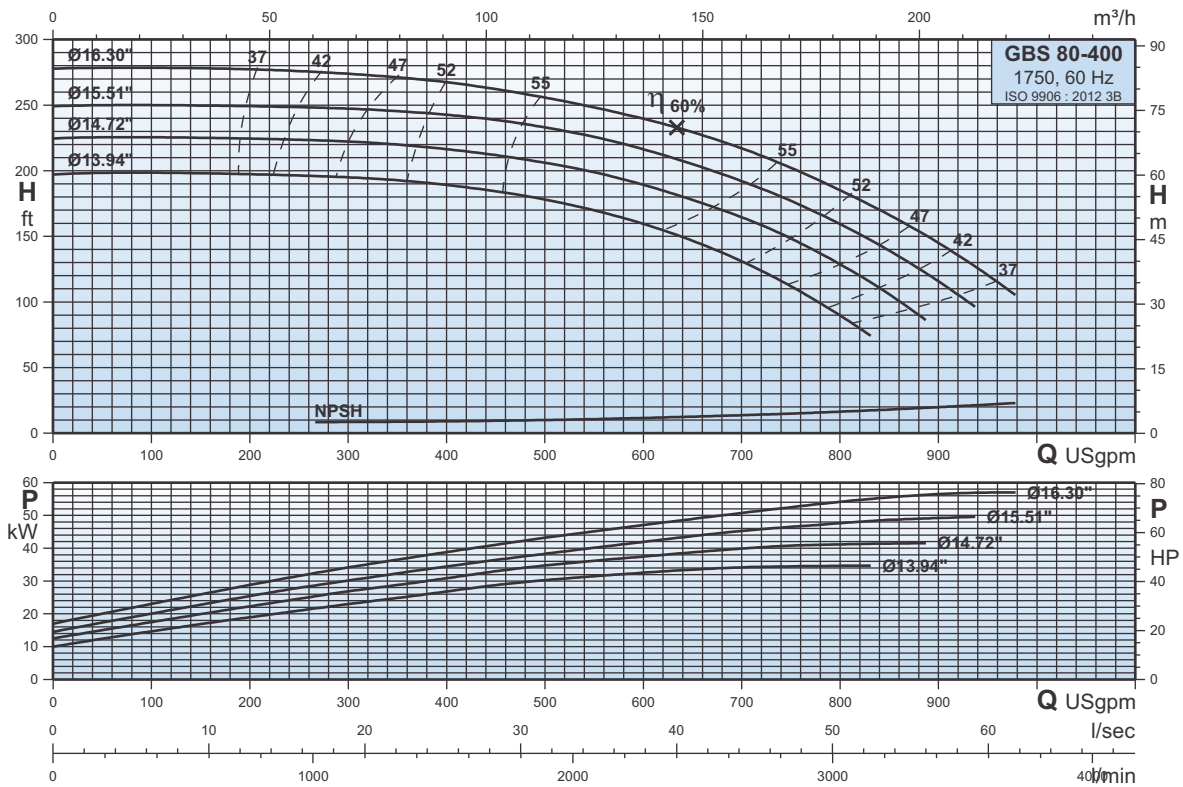

GBS 100-200

Curvas Características
Characteristic Curves
Courbes Caractéristiques

1750

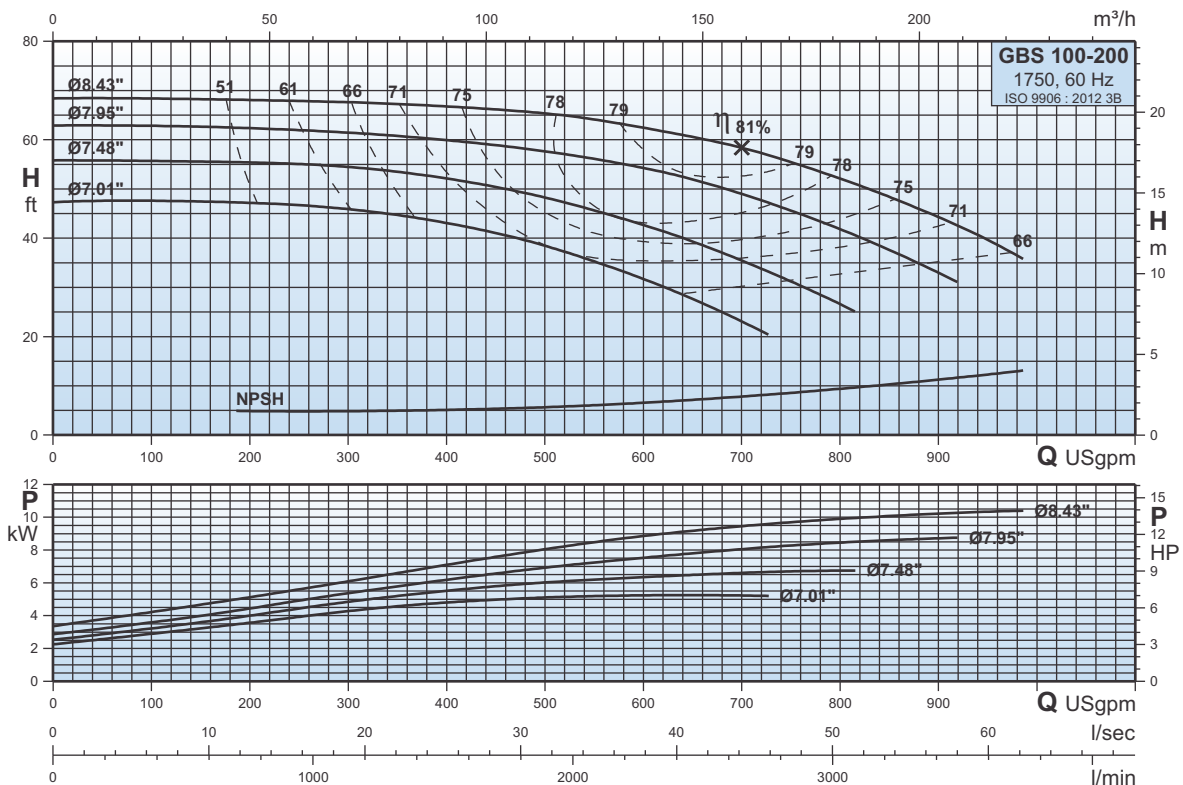

GBS 100-250

Curvas Características
Characteristic Curves
Courbes Caractéristiques

1750

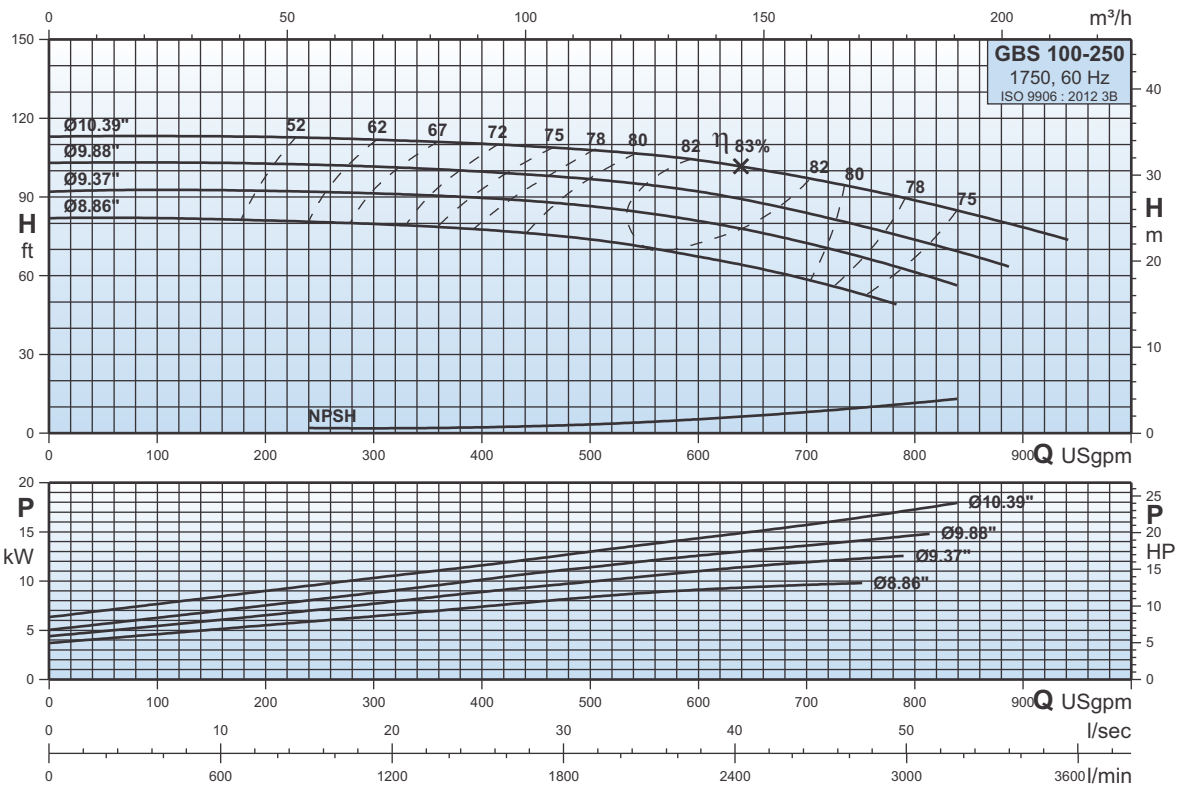

GBS 100-315

Curvas Características
Characteristic Curves
Courbes Caractéristiques

1750

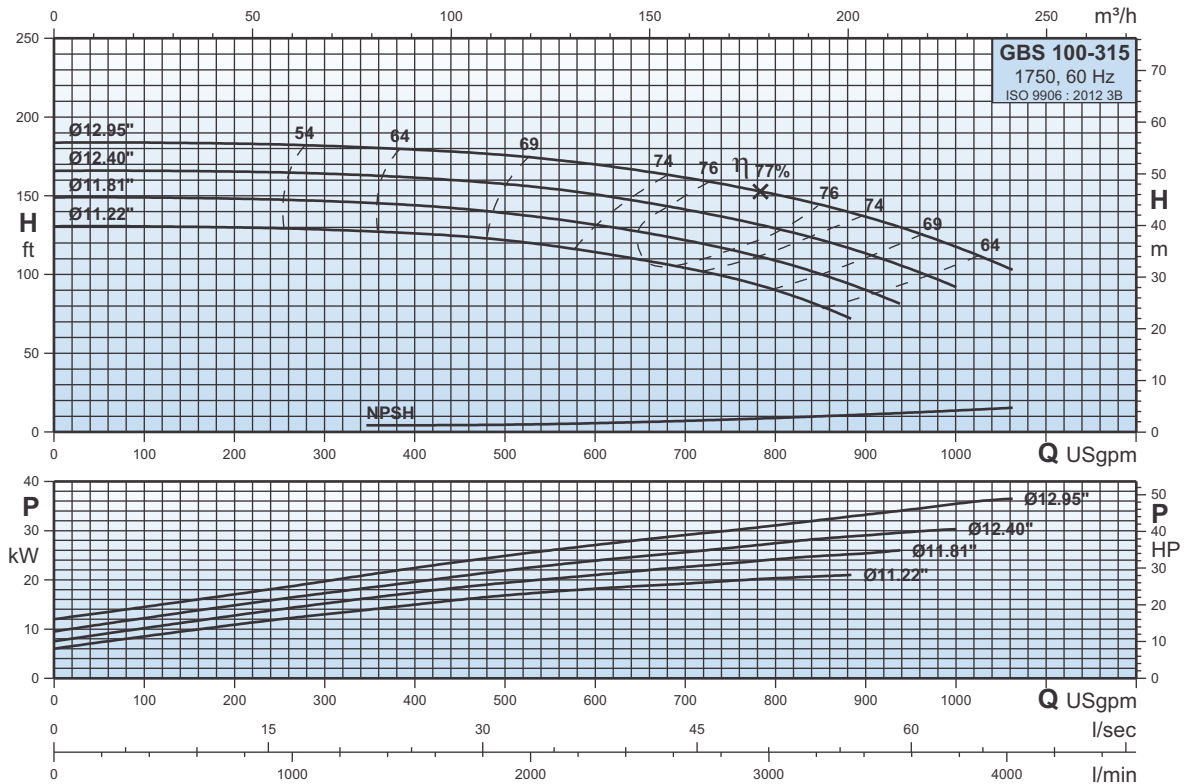

GBS 100-400

Curvas Características
Characteristic Curves
Courbes Caractéristiques

1750

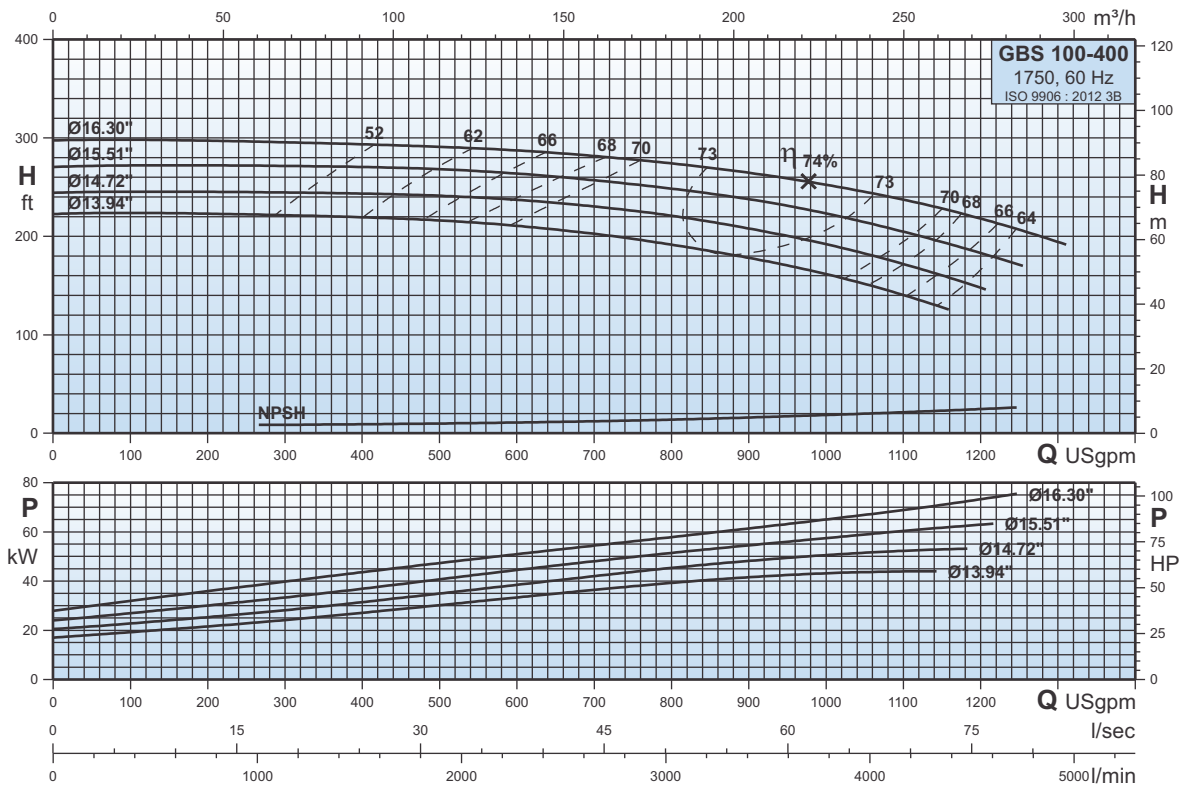

GBS 125-250

Curvas Características
Characteristic Curves
Courbes Caractéristiques

1750

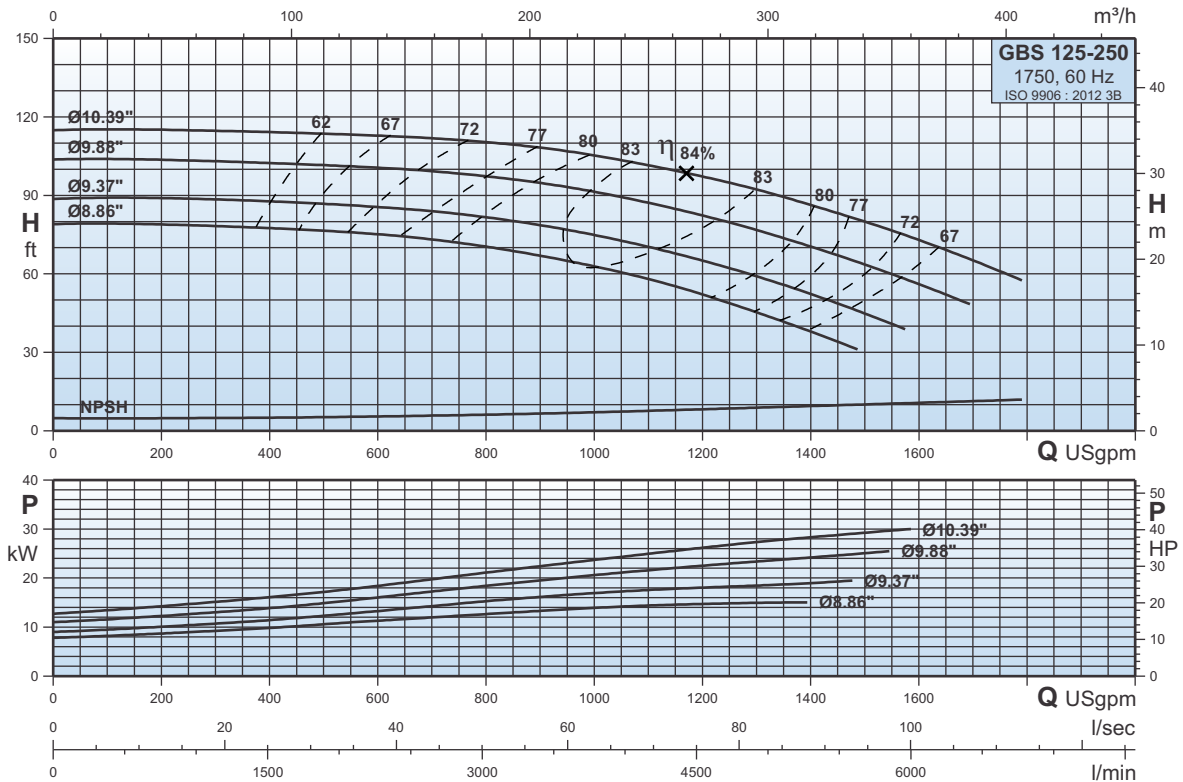

GBS 125-315

Curvas Características
Characteristic Curves
Courbes Caractéristiques

1750

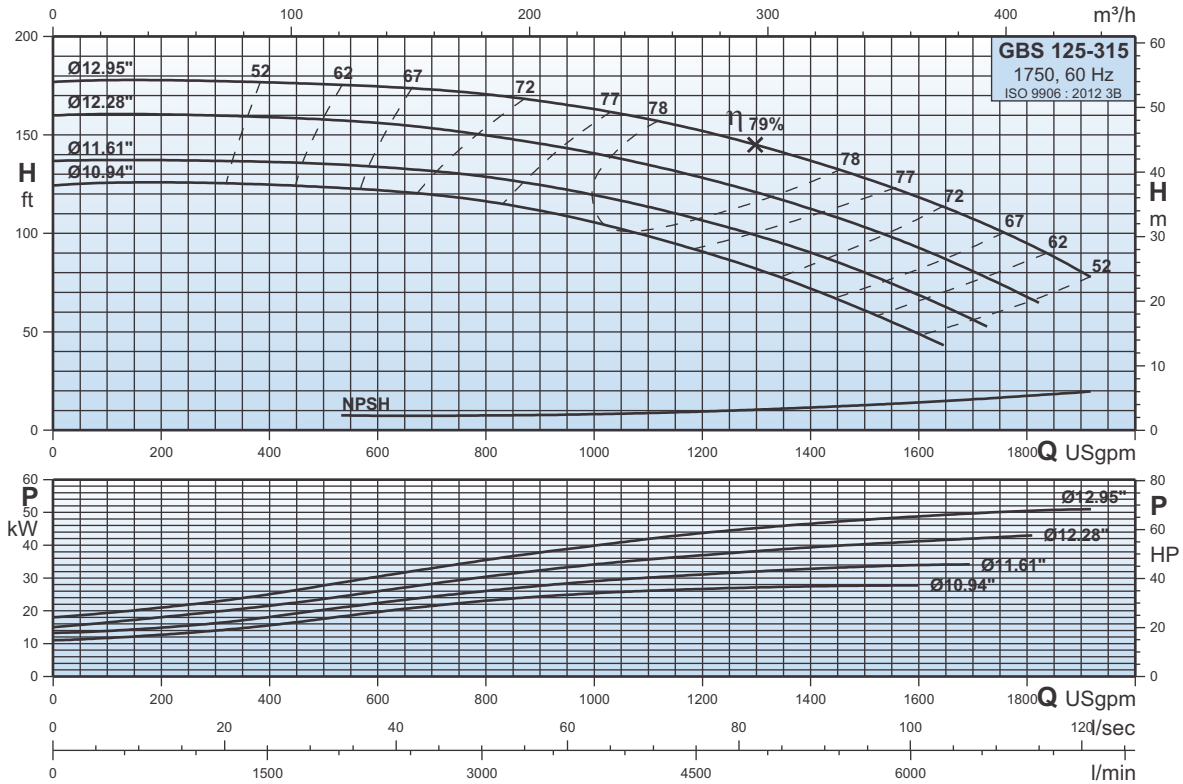

GBS 125-400

Curvas Características
Characteristic Curves
Courbes Caractéristiques

1750

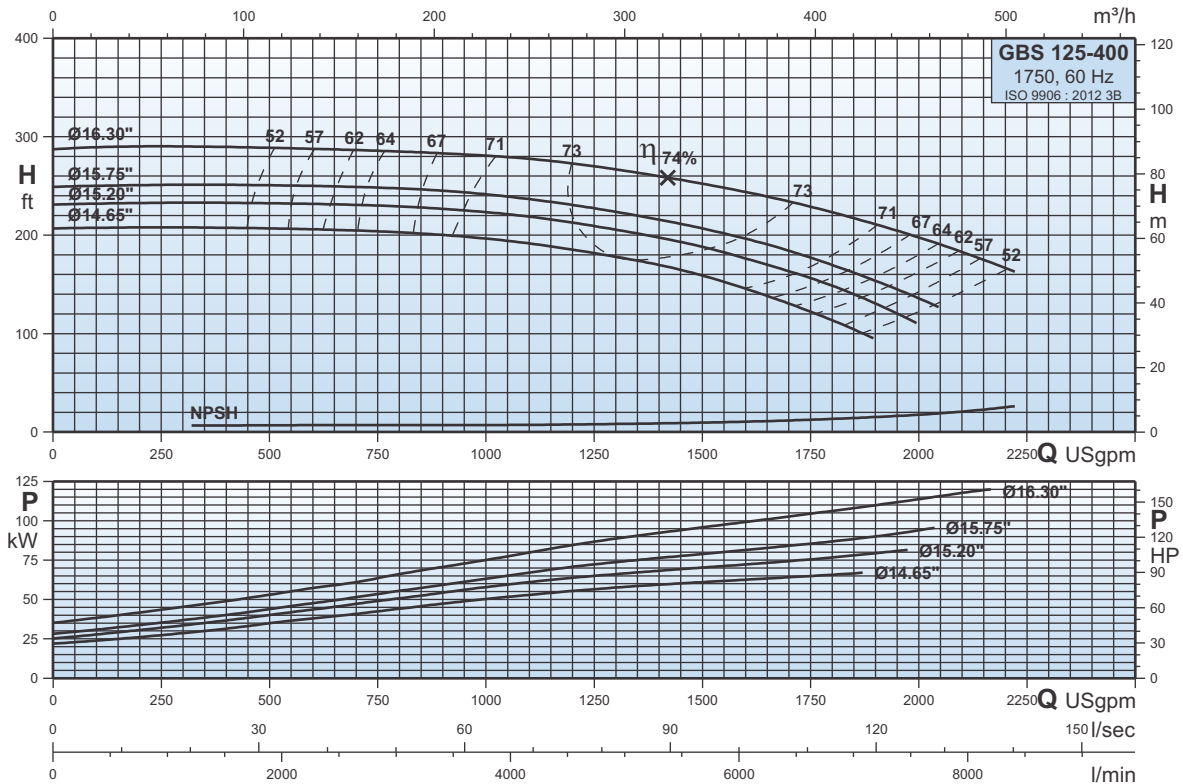

GBS 125-500

Curvas Características
Characteristic Curves
Courbes Caractéristiques

1750

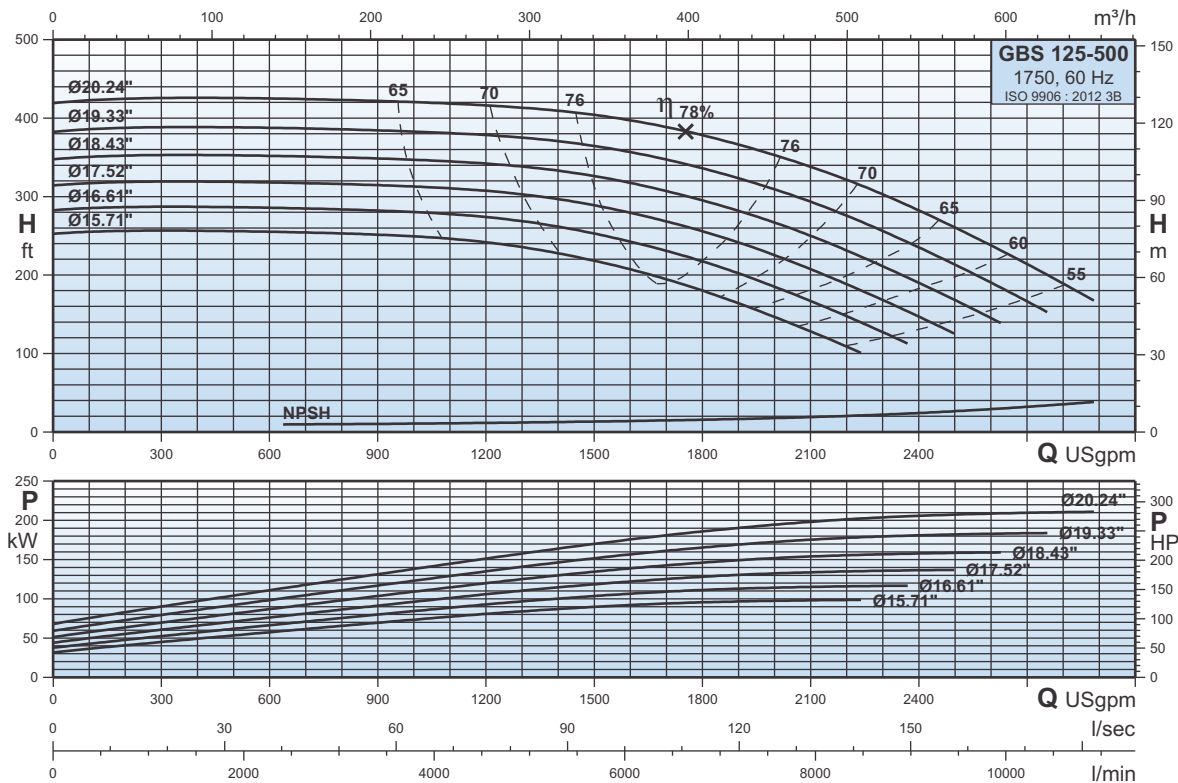

GBS 150-250

Curvas Características
Characteristic Curves
Courbes Caractéristiques

1750

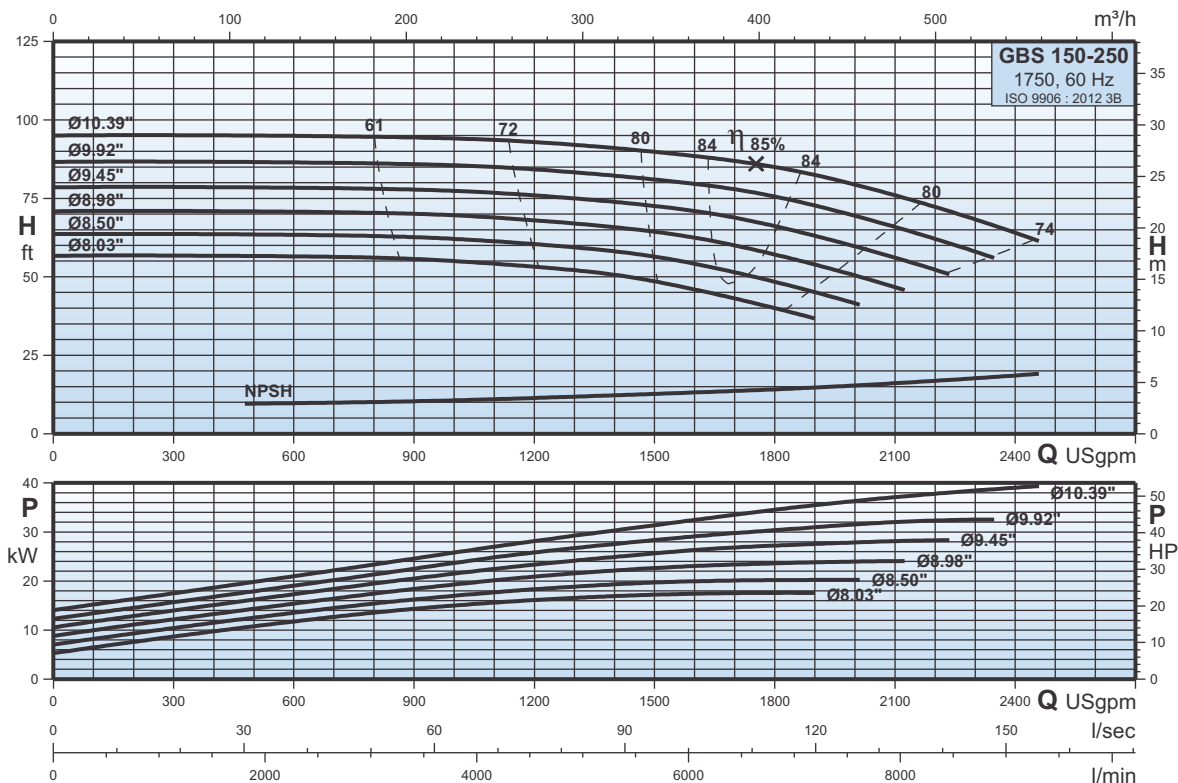

GBS 150-315

Curvas Características
Characteristic Curves
Courbes Caractéristiques

1750

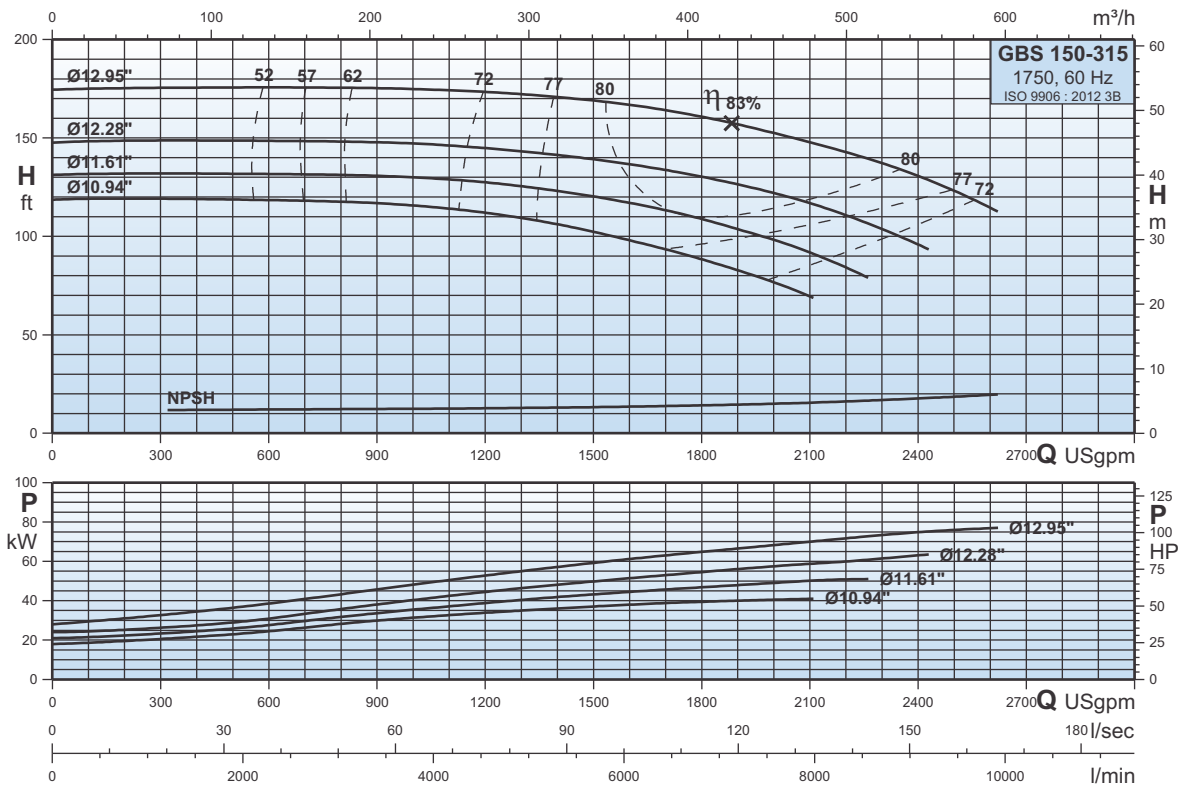

GBS 150-400

Curvas Características
Characteristic Curves
Courbes Caractéristiques

1750

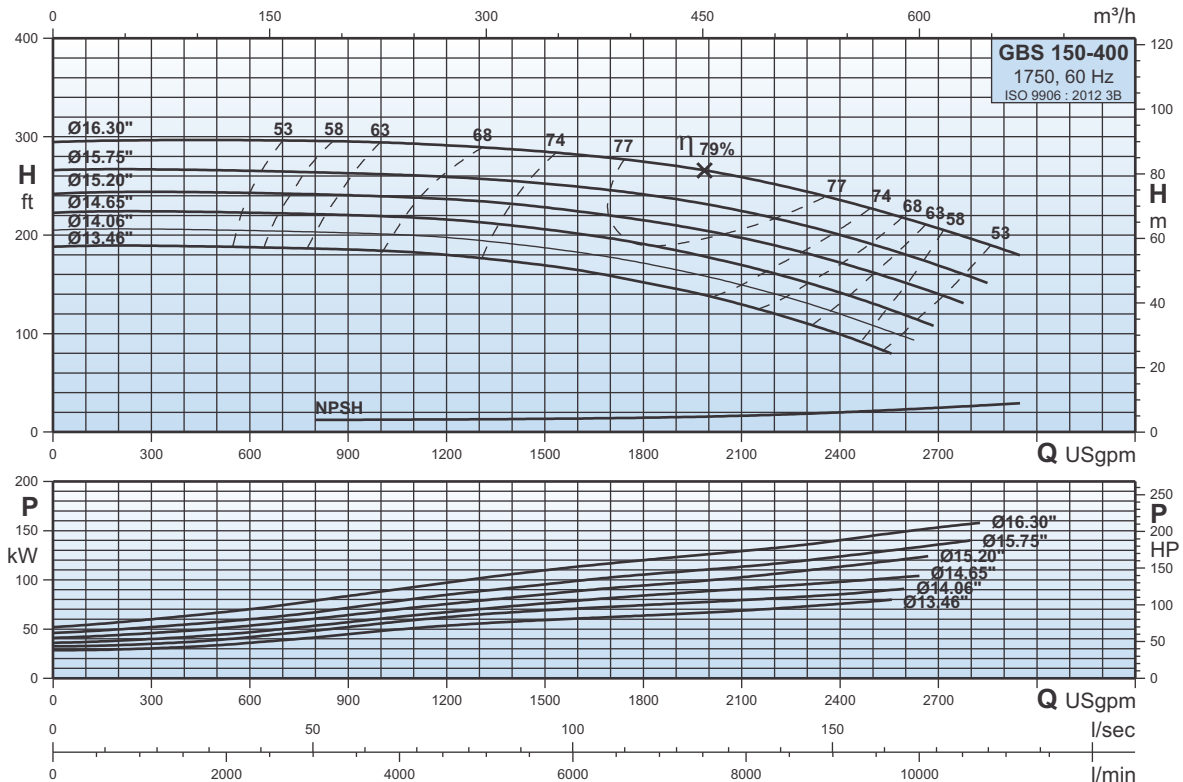

GBS 150-500

Curvas Características
Characteristic Curves
Courbes Caractéristiques

1750

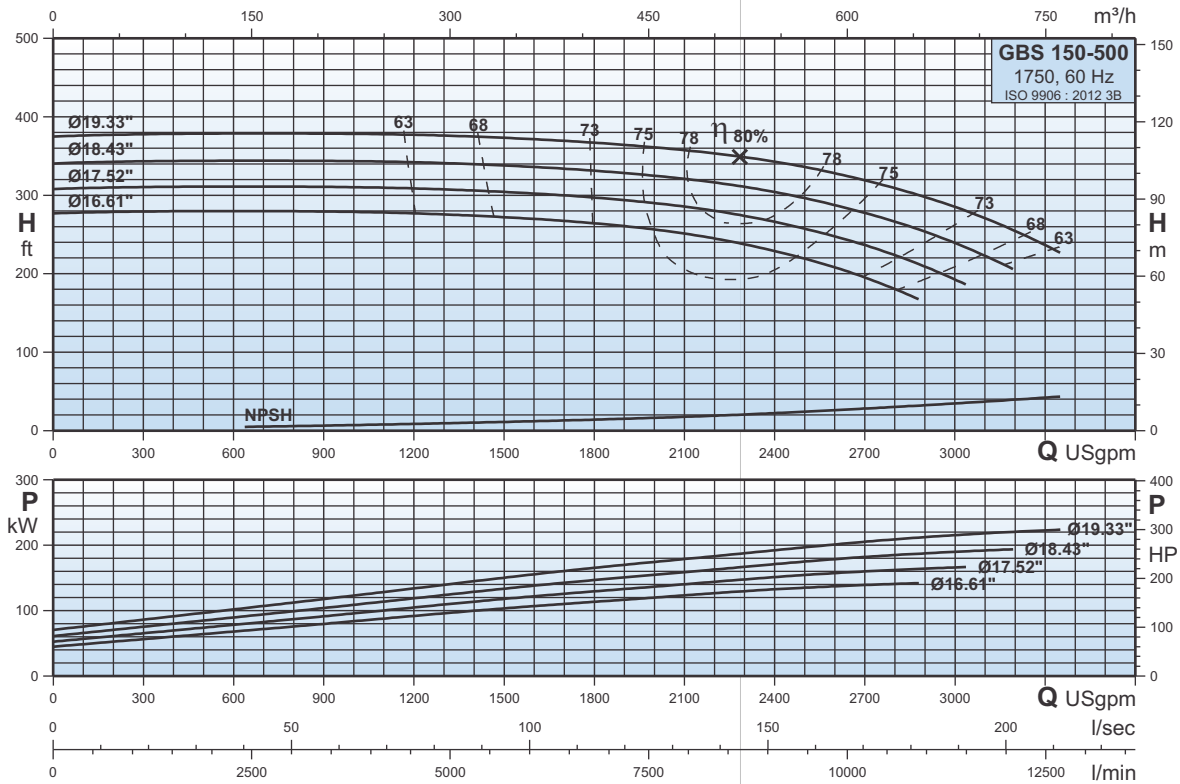

Dimensiones y pesos
Dimensions and Weights
Dimensions et poids

1750

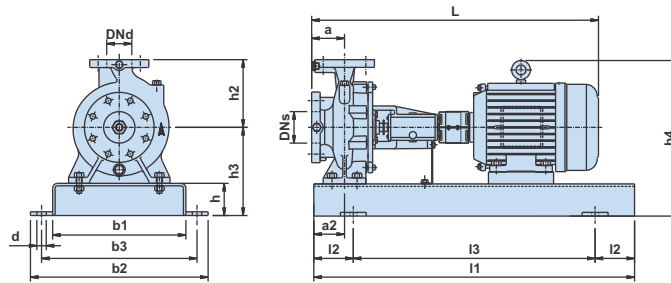

	GBS 32-160			GBS 32-200			GBS 32-3200L				GBS 32-250			GBS 40-125	GBS 40-125L
P₂ [HP]	1	1,5	2	1	1,5	2	1,5	2	3	4	3	4	5	1	1
[kW]	0,75	1,1	1,5	0,75	1,1	1,5	1,1	1,5	2,2	3	2,2	3	3,7	0,75	0,75
Carcasa/Frame/Armature	143T	145T	145T	143T	145T	145T	145T	145T	182T	184T	182T	184T	184T	143T	143T
ANSI [psi]	125	125	125	125	125	125	125	125	125	125	125	125	125	125	125
DN _s [pulgadas/inch/pouces]	2,00	2,00	2,00	2,00	2,00	2,00	2,00	2,00	2,00	2,00	2,00	2,00	2,00	2,50	2,50
DN _d [pulgadas/inch/pouces]	1,25	1,25	1,25	1,25	1,25	1,25	1,25	1,25	1,25	1,25	1,25	1,25	1,25	1,50	1,50
a [pulgadas/inch/pouces]	3,15	3,15	3,15	3,15	3,15	3,15	3,15	3,15	3,15	3,15	3,94	3,94	3,94	3,15	3,15
h ₂ [pulgadas/inch/pouces]	6,30	6,30	6,30	7,09	7,09	7,09	7,09	7,09	7,09	7,09	8,86	8,86	8,86	5,51	5,51
L [pulgadas/inch/pouces]	31,30	31,30	31,30	31,30	31,30	31,30	31,30	31,30	33,90	34,09	34,69	34,88	34,88	31,30	31,30
I ₁ [pulgadas/inch/pouces]	31,50	35,43	35,43	31,50	35,43	35,43	35,43	35,43	35,43	35,43	39,37	39,37	39,37	31,50	31,50
I ₂ [pulgadas/inch/pouces]	5,12	5,91	5,91	5,12	5,91	5,91	5,91	5,91	5,91	5,91	6,69	6,69	6,69	5,12	5,12
I ₃ [pulgadas/inch/pouces]	21,26	23,62	23,62	21,26	23,62	23,62	23,62	23,62	23,62	23,62	25,98	25,98	25,98	21,26	21,26
b ₁ [pulgadas/inch/pouces]	10,63	11,81	11,81	10,63	11,81	11,81	11,81	11,81	11,81	11,81	13,39	13,39	13,39	10,63	10,63
b ₂ [pulgadas/inch/pouces]	14,17	15,35	15,35	14,17	15,35	15,35	15,35	15,35	15,35	15,35	17,72	17,72	17,72	14,17	14,17
b ₃ [pulgadas/inch/pouces]	12,60	13,78	13,78	12,60	13,78	13,78	13,78	13,78	13,78	13,78	15,75	15,75	15,75	12,60	12,60
d [pulgadas/inch/pouces]	0,75	0,75	0,75	0,75	0,75	0,75	0,75	0,75	0,75	0,75	0,94	0,94	0,94	0,75	0,75
a ₂ [pulgadas/inch/pouces]	2,36	2,36	2,36	2,36	2,36	2,36	2,36	2,36	2,36	2,36	2,95	2,95	2,95	2,56	2,56
h [pulgadas/inch/pouces]	2,56	2,56	2,56	2,56	2,56	2,56	2,56	2,56	2,56	2,56	3,15	3,15	3,15	2,36	2,36
h ₃ [pulgadas/inch/pouces]	7,76	7,76	7,76	8,86	8,86	8,86	8,86	8,86	8,86	8,86	10,24	10,24	10,24	6,97	6,97
h ₄ [pulgadas/inch/pouces]	12,99	12,99	12,99	14,09	14,09	14,09	14,09	14,09	15,00	15,00	16,38	16,38	16,38	12,20	12,20
Tipo de bancada numero Base frame type no. Numéro du type d'armature	2	3	3	2	3	3	3	3	3	3	4	4	4	2	2
Peso neto Net weight Poids net	157	165	169	168	176	180	172	176	205	209	238	242	247	142	142
Peso bruto Gross weight Poids brut	276	284	288	287	295	299	291	295	324	328	407	411	416	261	261
Volumen bruto Gross volume Volume brut	12,92	12,92	12,92	12,92	12,92	12,92	12,92	12,92	12,92	12,92	22,70	22,70	22,70	12,92	12,92

	GBS 40-160			GBS 40-200				GBS 40-250			GBS 40-250L				GBS 50-125	
P₂ [HP]	1	1,5	2	1,5	2	3	4	4	5	7,5	4	5	7,5	10	1	1,5
[kW]	0,75	1,1	1,5	1,1	1,5	2,2	3	3	3,7	5,5	3	3,7	5,5	7,5	0,75	1,1
Carcasa/Frame/Armature	143T	145T	145T	145T	145T	182T	184T	184T	184T	213T	184T	184T	213T	215T	143T	145T
ANSI [psi]	125	125	125	125	125	125	125	125	125	125	125	125	125	125	125	125
DN _s [pulgadas/inch/pouces]	2,50	2,50	2,50	2,50	2,50	2,50	2,50	2,50	2,50	2,50	2,50	2,50	2,50	2,5	2,50	2,50
DN _d [pulgadas/inch/pouces]	1,50	1,50	1,50	1,50	1,50	1,50	1,50	1,50	1,50	1,50	1,50	1,50	1,50	1,5	2,00	2,00
a [pulgadas/inch/pouces]	3,15	3,15	3,15	3,94	3,94	3,94	3,94	3,94	3,94	3,94	3,94	3,94	3,94	3,94	3,94	3,94
h ₂ [pulgadas/inch/pouces]	6,30	6,30	6,30	7,09	7,09	7,09	7,09	8,86	8,86	8,86	8,86	8,86	8,86	8,86	8,86	6,30
L [pulgadas/inch/pouces]	31,30	31,30	31,30	32,05	32,05	34,69	34,88	34,88	34,88	38,78	34,88	34,88	38,78	38,07	32,05	32,05
I ₁ [pulgadas/inch/pouces]	31,50	35,43	35,43	35,43	35,43	35,43	35,43	39,37	39,37	44,09	39,37	39,37	44,09	44,09	31,50	35,43
I ₂ [pulgadas/inch/pouces]	5,12	5,91	5,91	5,91	5,91	5,91	5,91	6,69	6,69	7,48	6,69	6,69	7,48	7,48	5,12	5,91
I ₃ [pulgadas/inch/pouces]	21,26	23,62	23,62	23,62	23,62	23,62	23,62	25,98	25,98	29,13	25,98	25,98	29,13	29,13	21,26	23,62
b ₁ [pulgadas/inch/pouces]	10,63	11,81	11,81	11,81	11,81	11,81	11,81	13,39	13,39	14,96	13,39	13,39	14,96	14,96	10,63	11,81
b ₂ [pulgadas/inch/pouces]	14,17	15,35	15,35	15,35	15,35	15,35	15,35	17,72	17,72	19,29	17,72	17,72	19,29	19,29	14,17	15,35
b ₃ [pulgadas/inch/pouces]	12,60	13,78	13,78	13,78	13,78	13,78	13,78	15,75	15,75	17,32	15,75	15,75	17,32	17,32	12,60	13,78
d [pulgadas/inch/pouces]	0,75	0,75	0,75	0,75	0,75	0,75	0,75	0,94	0,94	0,94	0,94	0,94	0,94	0,94	0,75	0,75
a ₂ [pulgadas/inch/pouces]	2,36	2,36	2,36	2,36	2,36	2,36	2,36	2,95	2,95	2,95	2,95	2,95	2,95	2,95	2,36	2,36
h [pulgadas/inch/pouces]	2,56	2,56	2,56	2,56	2,56	2,56	2,56	3,15	3,15	3,15	3,15	3,15	3,15	3,15	2,56	2,56
h ₃ [pulgadas/inch/pouces]	7,76	7,76	7,76	8,86	8,86	8,86	8,86	10,24	10,24	10,24	10,24	10,24	10,24	10,24	7,76	7,76
h ₄ [pulgadas/inch/pouces]	12,99	12,99	12,99	14,09	14,09	15,00	15,00	16,38	16,38	17,56	16,38	16,38	17,56	17,56	12,99	12,99
Tipo de bancada numero Base frame type no. Numéro du type d'armature	2	3	3	3	3	3	3	4	4	5	4	4	5	5	2	3
Peso neto Net weight Poids net	149	156	161	167	172	200	205	251	256	331	251	256	331	356	146	154
Peso bruto Gross weight Poids brut	268	275	280	286	291	319	324	420	425	500	420	425	500	515	265	273
Volumen bruto Gross volume Volume brut	12,92	12,92	12,92	12,92	12,92	12,92	12,92	22,70	22,70	22,70	22,70	22,70	22,70	21,06	12,92	12,92

Nota: Todas las medidas estan basadas con acoplamiento estandar, las dimensiones cambian con el acoplamiento espaciador.

Note: All dimensions are based on standard coupling, dimensions will change for spacer coupling.

Note: Toutes les dimensions sont fondées sur la norme coupling, les dimensions changeront pour l'entretoise coupling.

GBS 80-200

Curvas Características
Characteristic Curves
Courbes Caractéristiques

1150

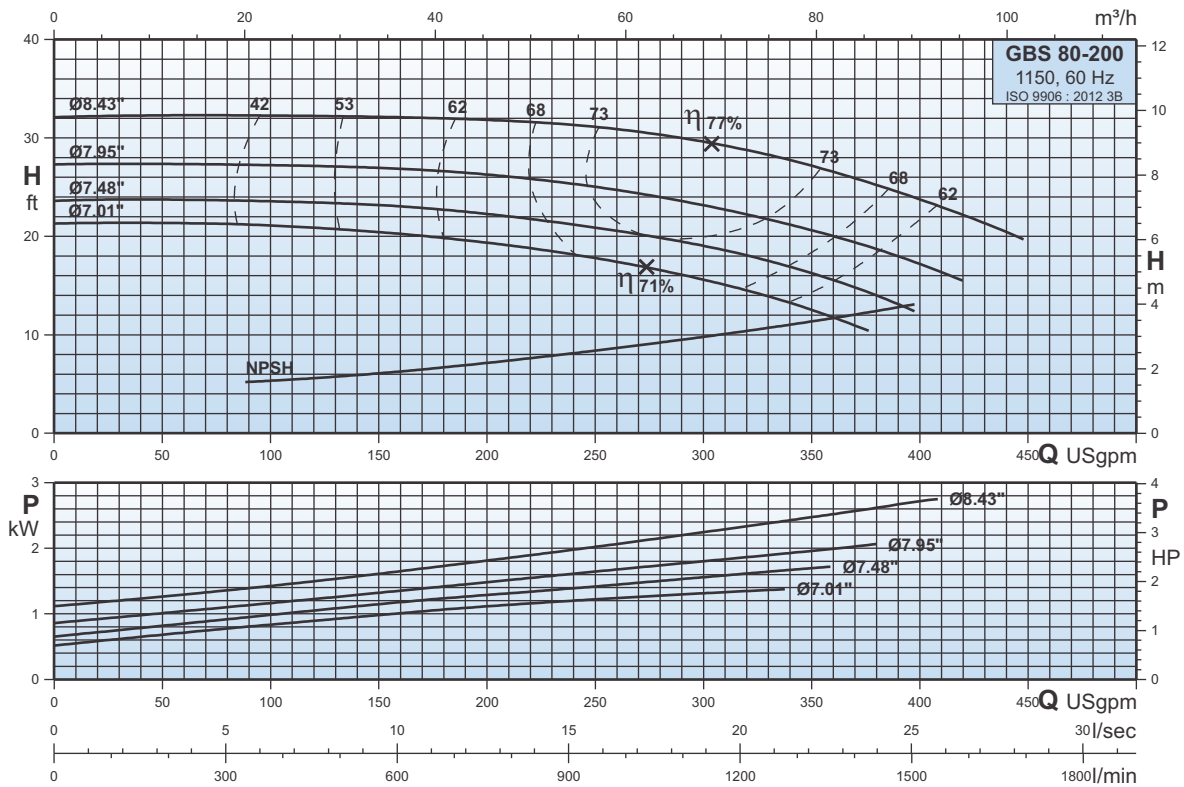

GBS 80-250

Curvas Características
Characteristic Curves
Courbes Caractéristiques

1150

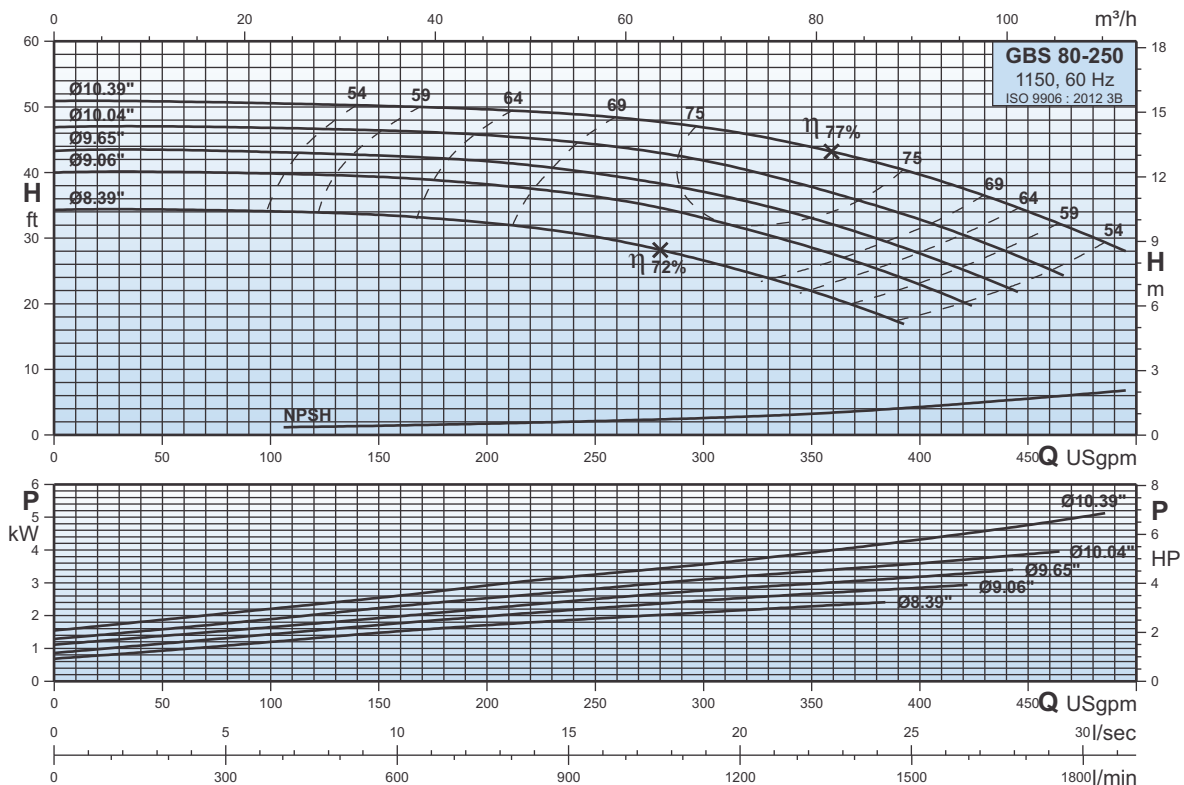

GBS 65-250L

Curvas Características
Characteristic Curves
Courbes Caractéristiques

1150

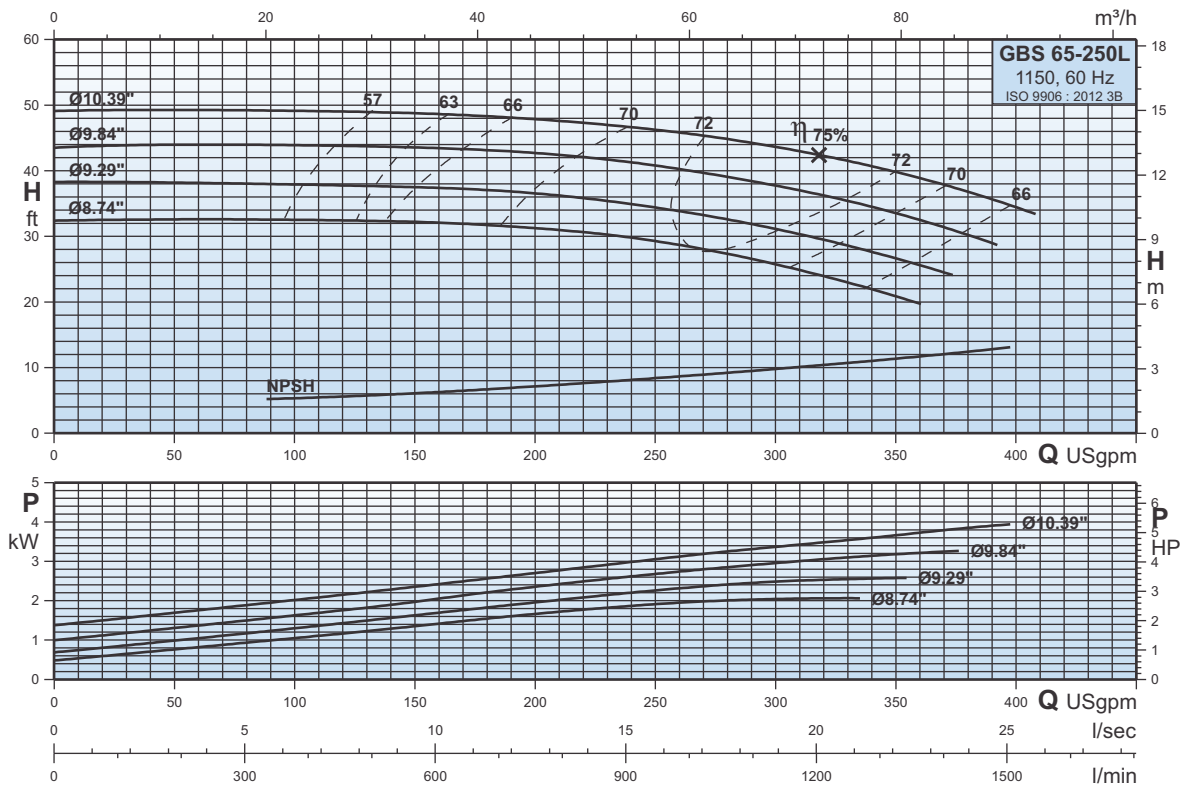

GBS 80-315

Curvas Características
Characteristic Curves
Courbes Caractéristiques

1150

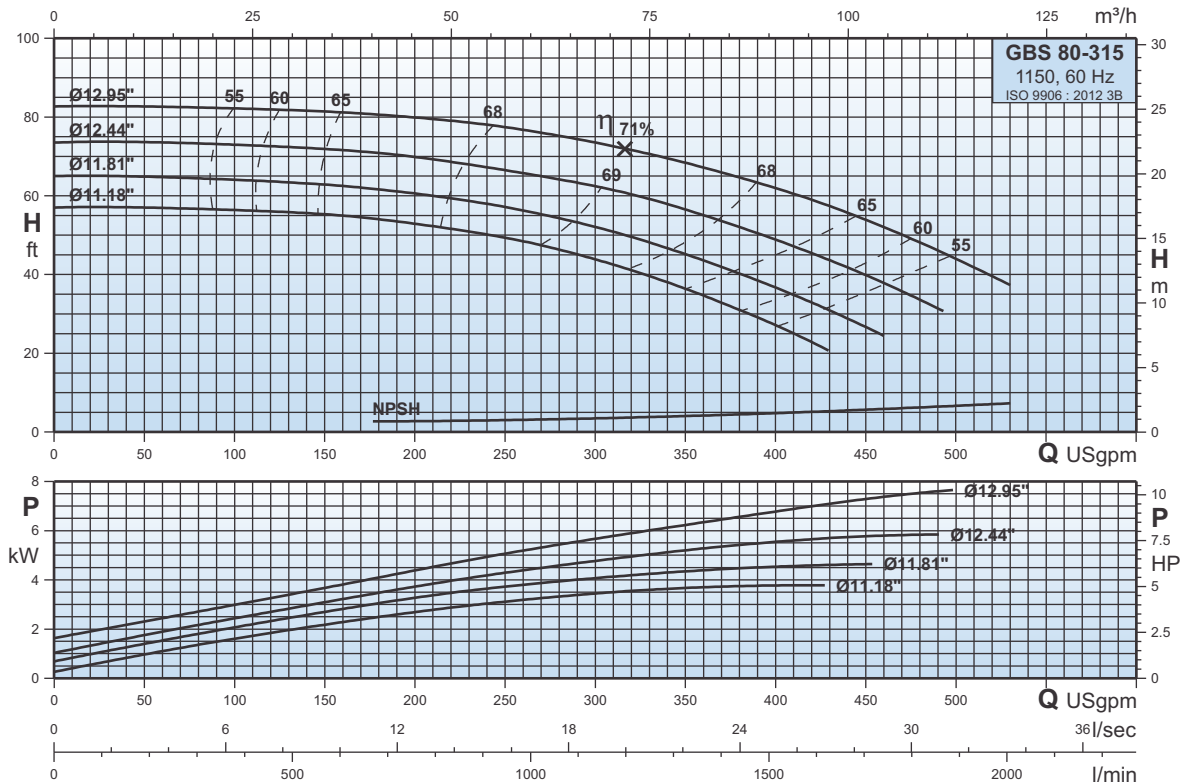

GBS 80-400

Curvas Características
Characteristic Curves
Courbes Caractéristiques

1150

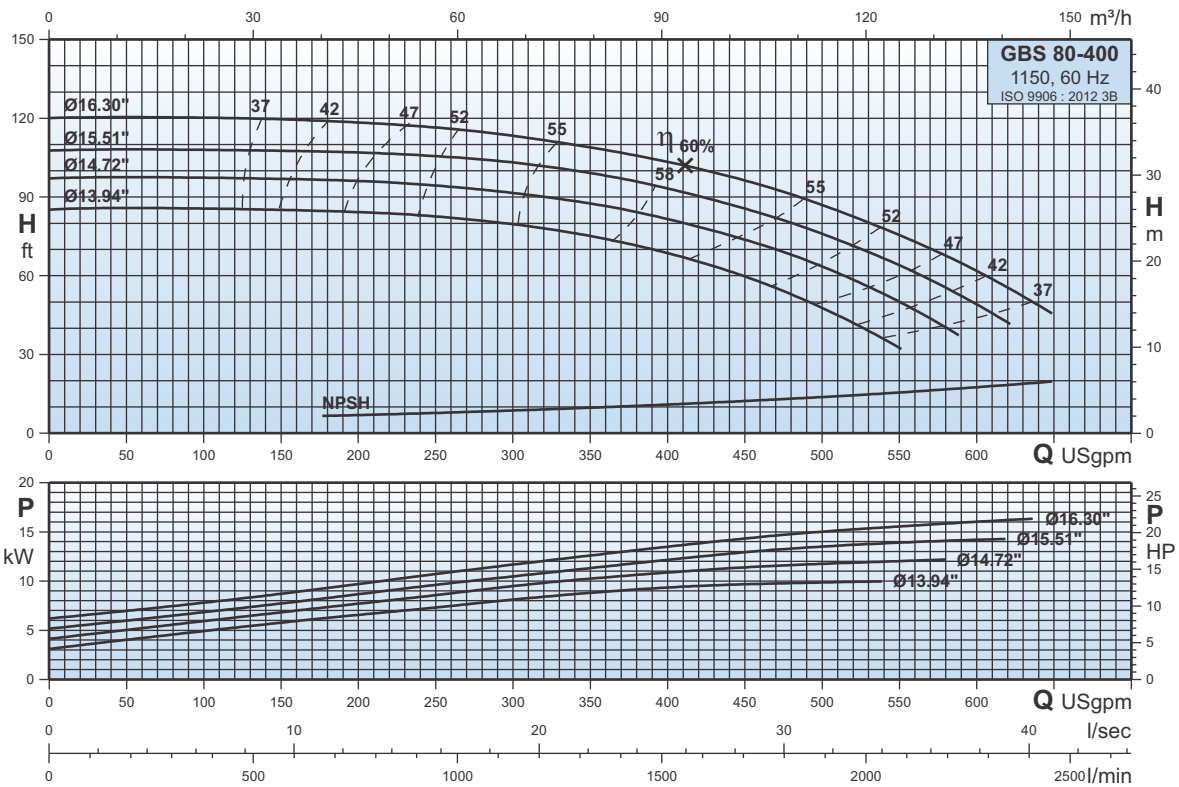

GBS 100-200

Curvas Características
Characteristic Curves
Courbes Caractéristiques

1150

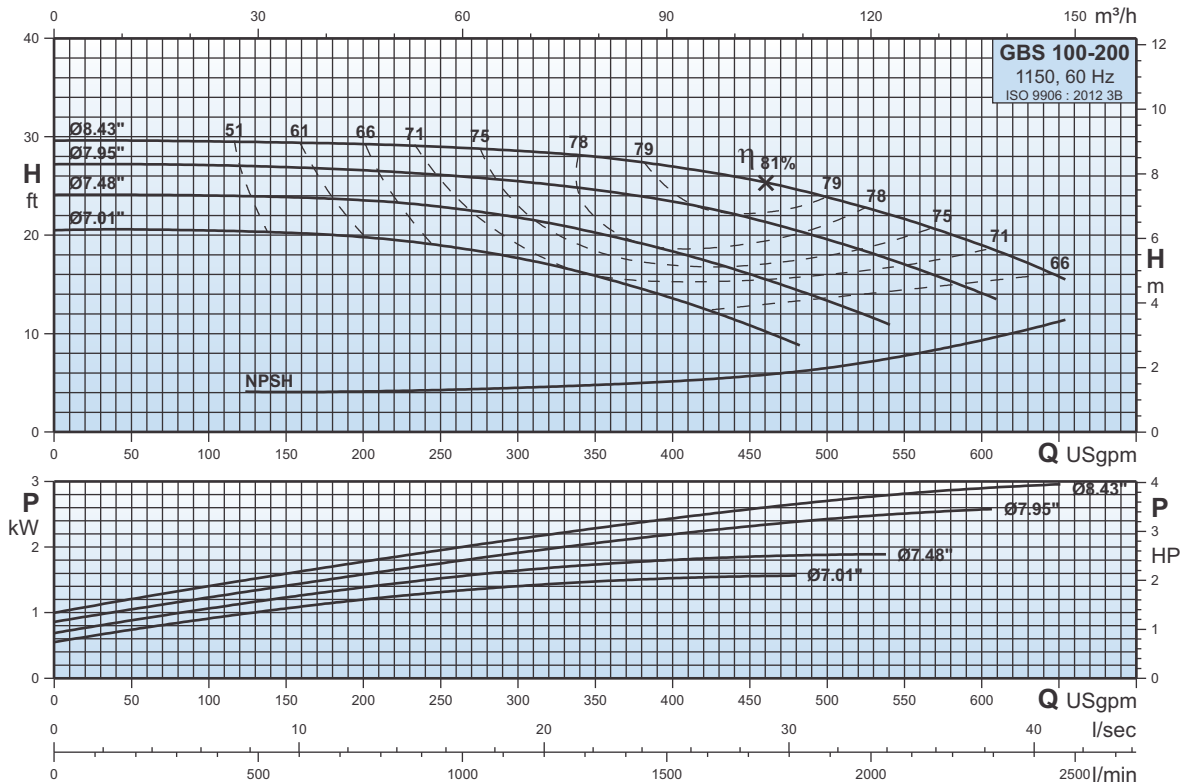

GBS 100-250

Curvas Características
Characteristic Curves
Courbes Caractéristiques

1150

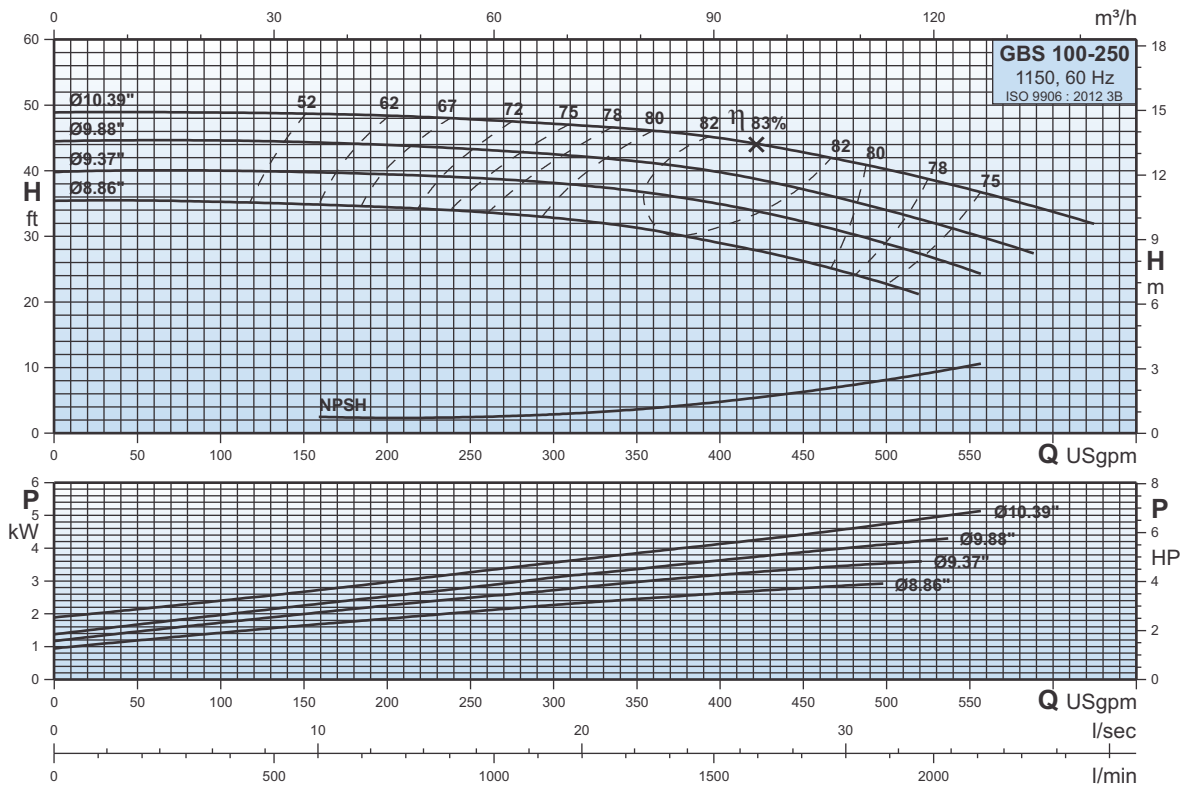

GBS 100-315

Curvas Características
Characteristic Curves
Courbes Caractéristiques

1150

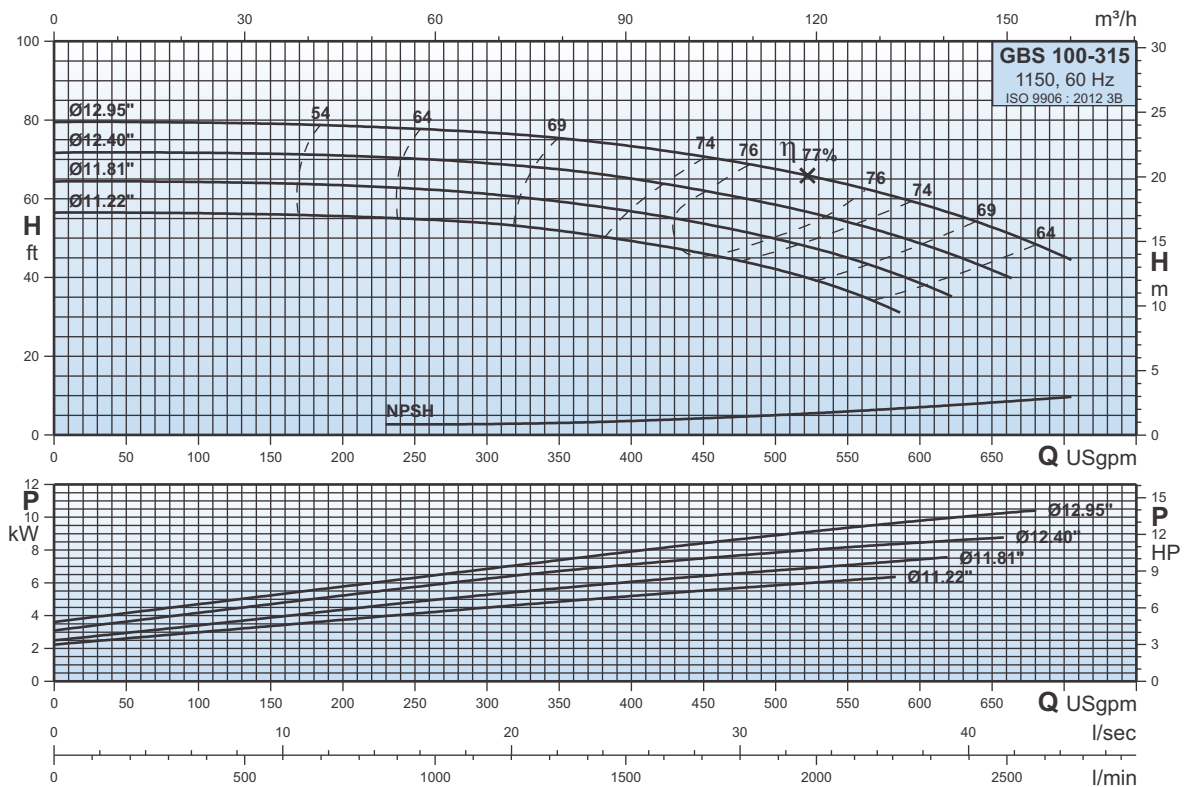

GBS 100-400

Curvas Características
Characteristic Curves
Courbes Caractéristiques

1150

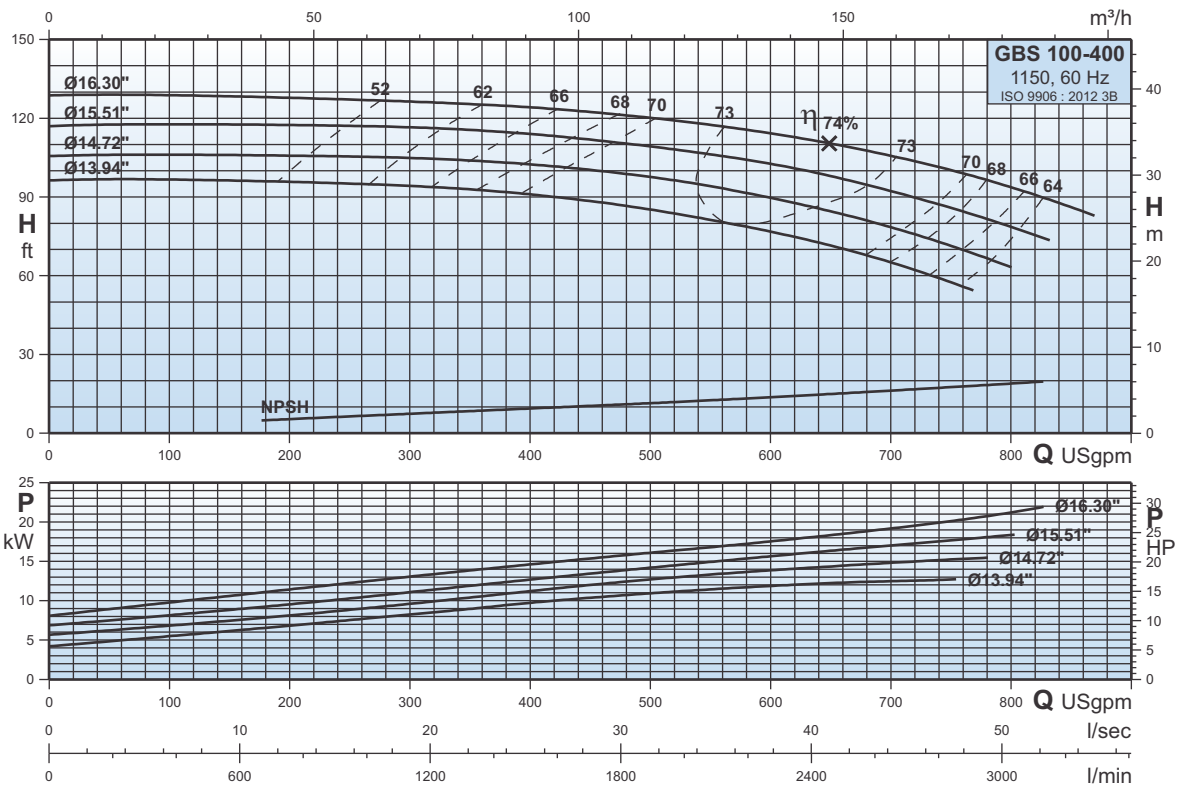

GBS 125-250

Curvas Características
Characteristic Curves
Courbes Caractéristiques

1150

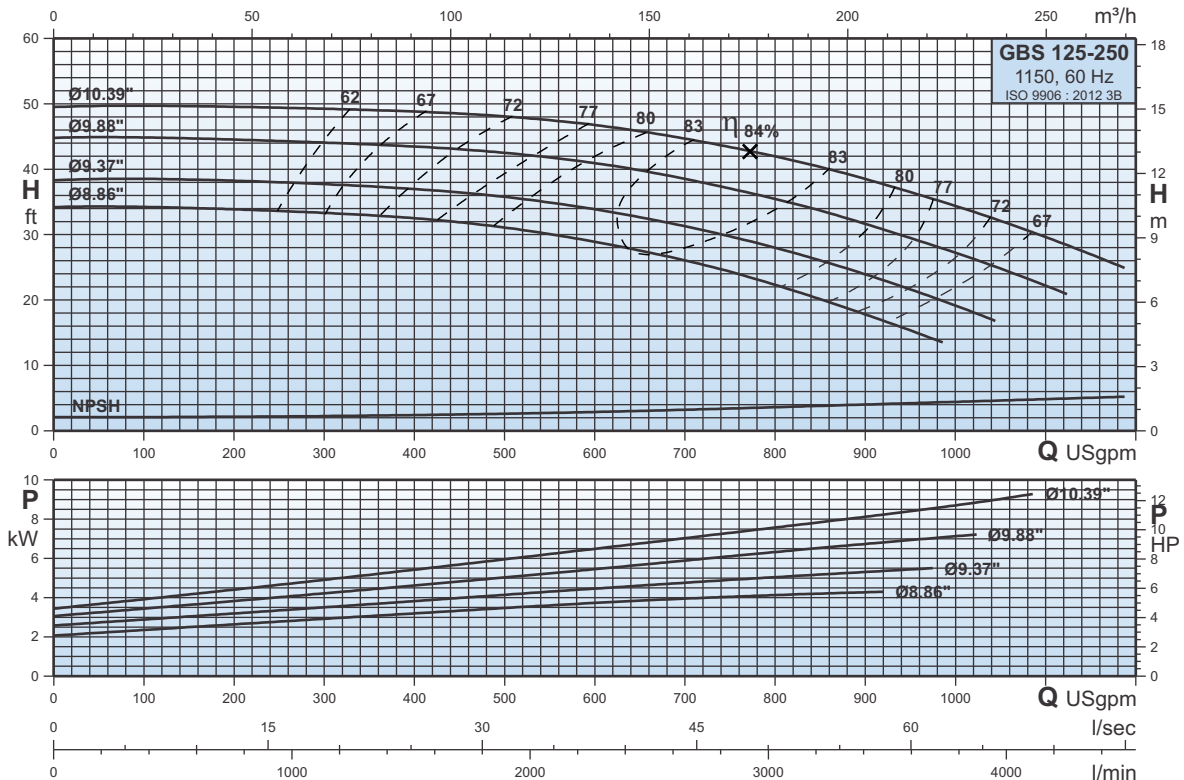

GBS 125-315

Curvas Características
Characteristic Curves
Courbes Caractéristiques

1150

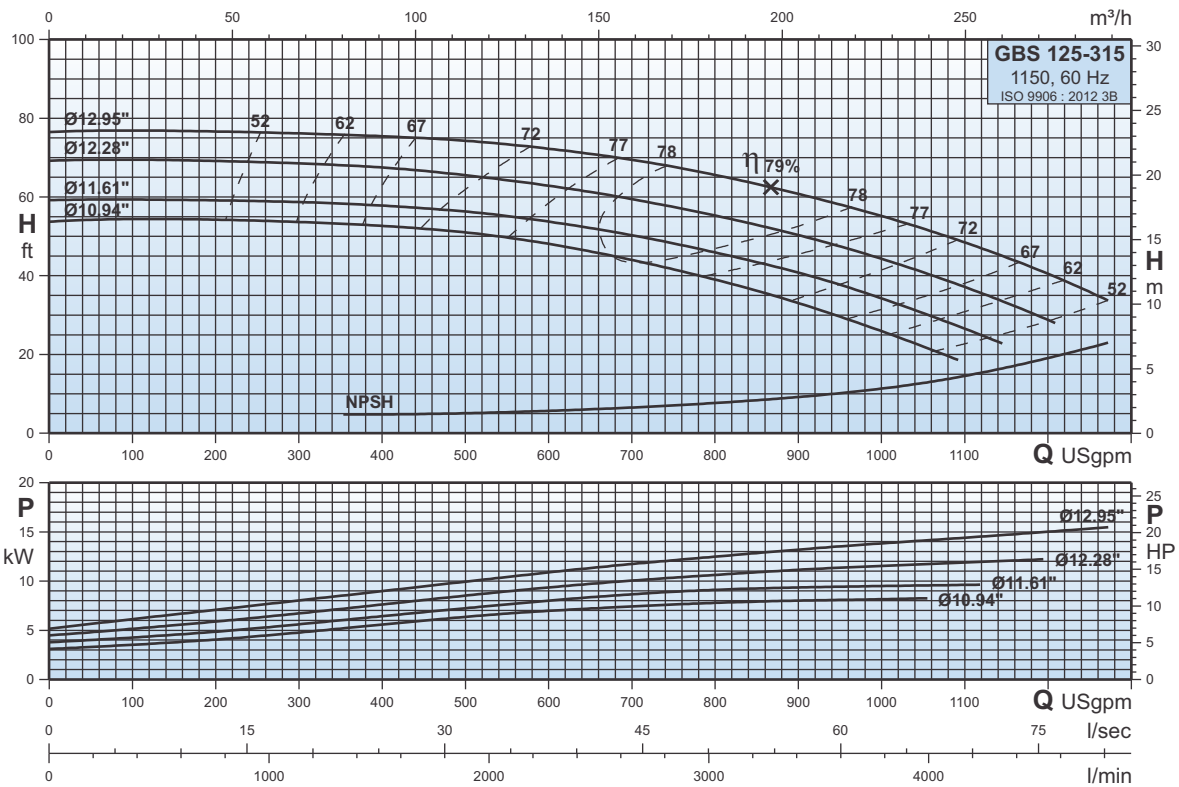

GBS 125-400

Curvas Características
Characteristic Curves
Courbes Caractéristiques

1150

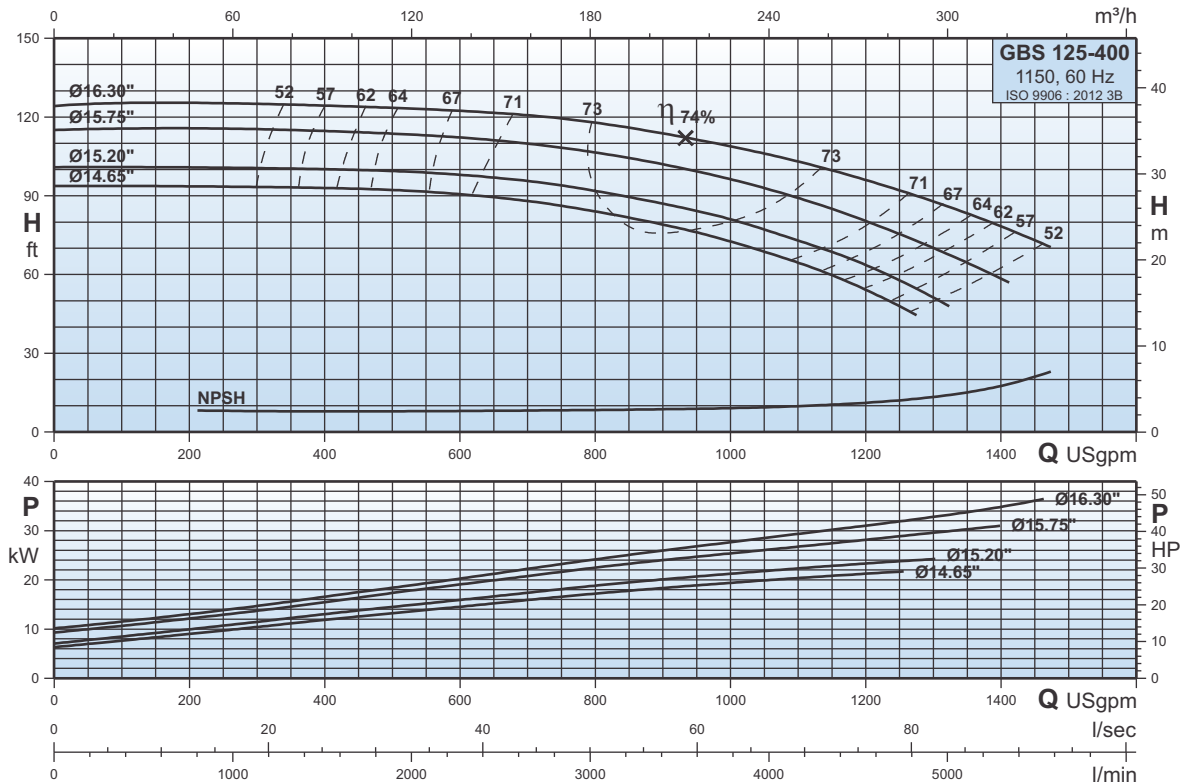

GBS 125-500

Curvas Características
Characteristic Curves
Courbes Caractéristiques

1150

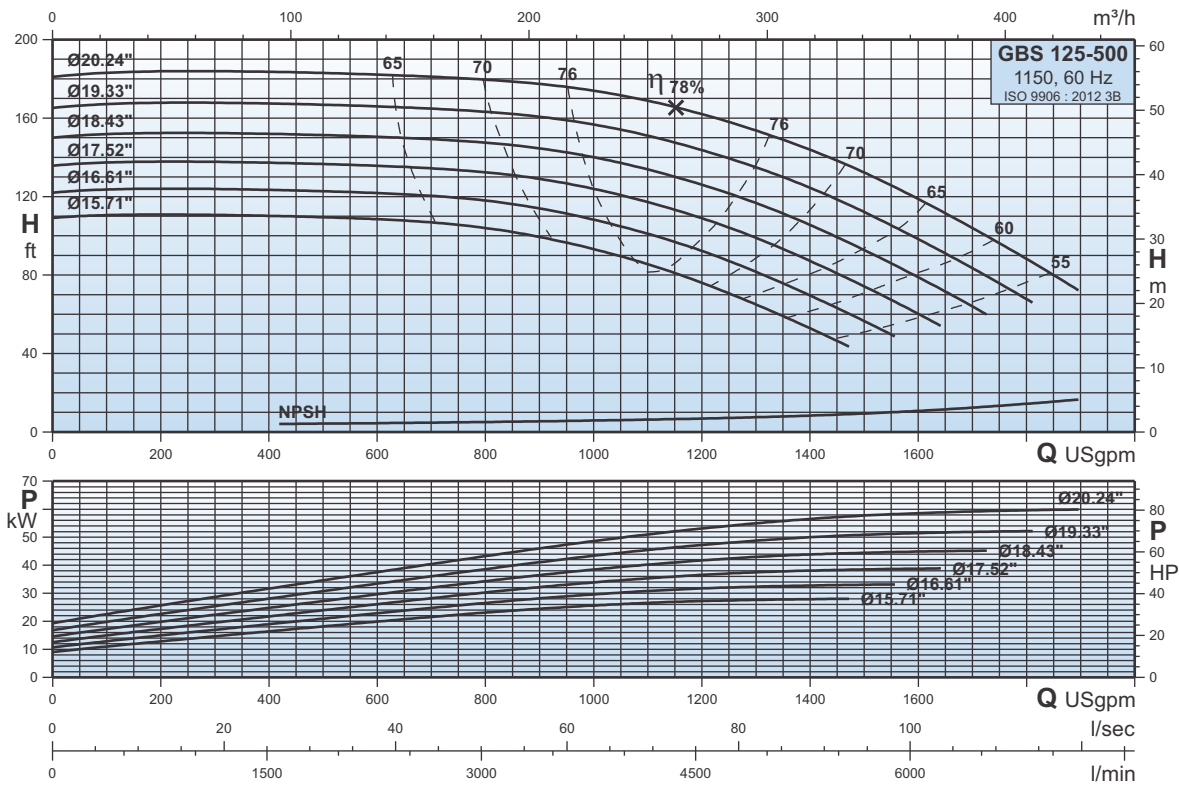

GBS 150-250

Curvas Características
Characteristic Curves
Courbes Caractéristiques

1150

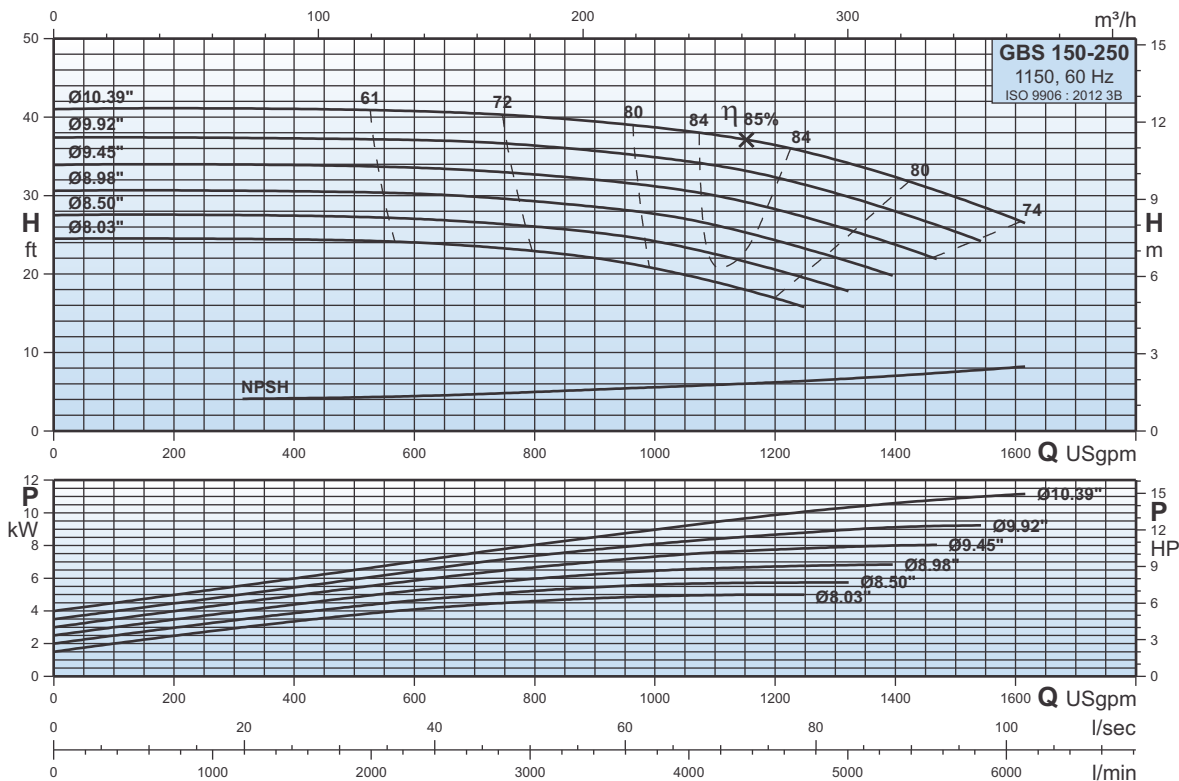

GBS 150-315

Curvas Características
Characteristic Curves
Courbes Caractéristiques

1150

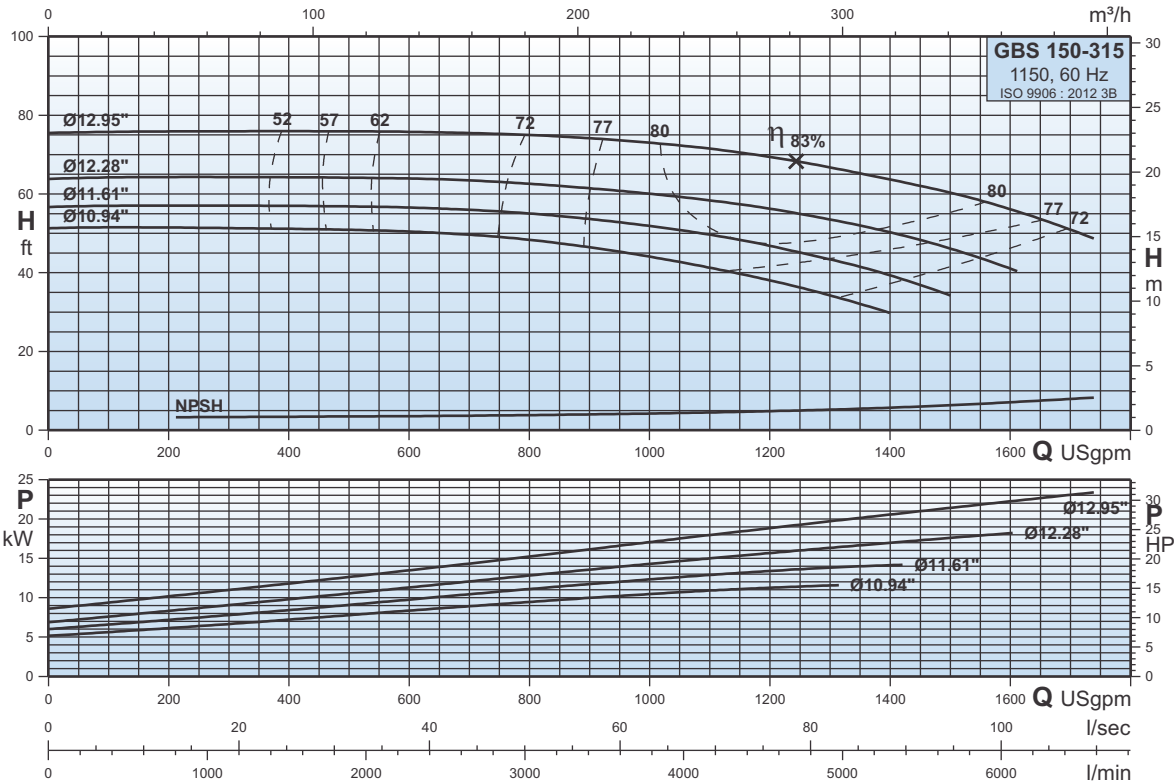

GBS 150-400

Curvas Características
Characteristic Curves
Courbes Caractéristiques

1150

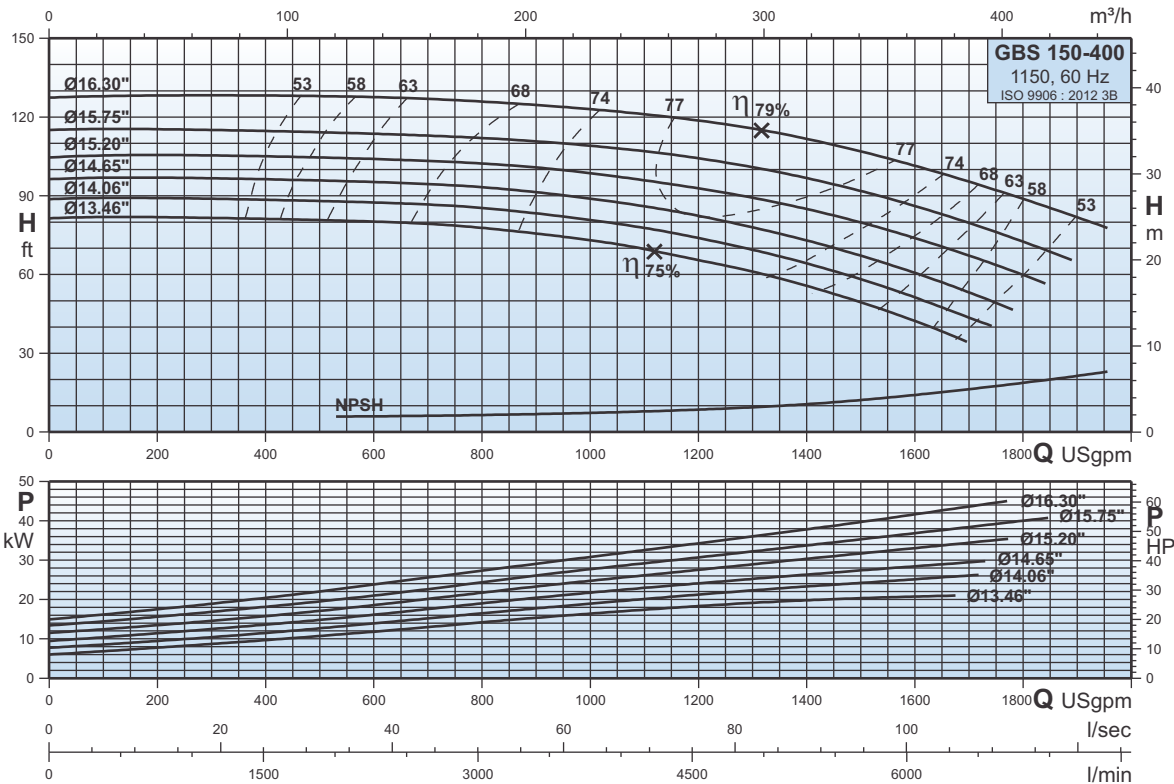

Dimensiones y pesos Dimensions and Weights Dimensions et poids

1150

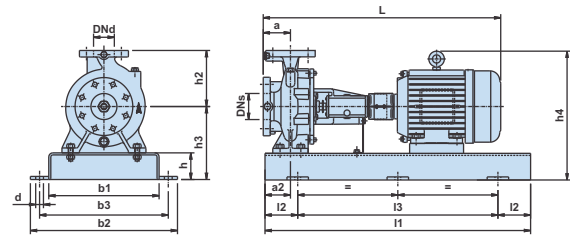
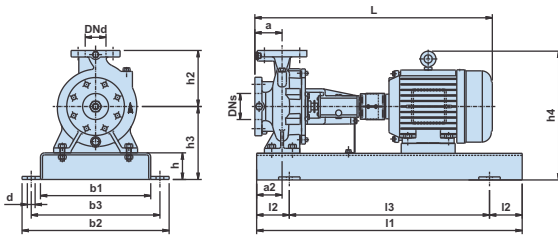

GBS 80-200, GBS80-250, GBS 65-250L, GBS 80-315
GBS 100-200, GBS 100-250, GBS 100-315

GBS 80-400

P ₂	[HP] [kW]	GBS 80-200				GBS 80-250				GBS 65-250L			GBS 80-315		
		1,5	2	3	4	3	4	5	7,5	3	4	5	5	7,5	10
Carcasa/Frame/Armature		182T	184T	213T	215T	213T	215T	215T	254T	213T	215T	215T	215T	254T	256T
ANSI	[psi]	125	125	125	125	125	125	125	125	125	125	125	125	125	125
DN _S	[pulgadas/inch/pouces]	4,00	4,00	4,00	4,00	4,00	4,00	4,00	4,00	4,00	4,00	4,00	4,00	4,00	4,00
DN _d	[pulgadas/inch/pouces]	3,00	3,00	3,00	3,00	3,00	3,00	3,00	3,00	2,50	2,50	2,50	3,00	3,00	3,00
a	[pulgadas/inch/pouces]	4,92	4,92	4,92	4,92	4,92	4,92	4,92	4,92	3,94	3,94	3,94	4,92	4,92	4,92
h ₂	[pulgadas/inch/pouces]	9,84	9,84	9,84	9,84	11,02	11,02	11,02	11,02	9,84	9,84	9,84	12,40	12,40	12,40
L	[pulgadas/inch/pouces]	40,20	40,20	44,09	44,09	43,94	43,94	43,94	47,48	42,95	43,11	43,11	44,09	47,48	49,13
I ₁	[pulgadas/inch/pouces]	44,09	44,09	44,09	44,09	49,21	49,21	49,21	49,21	44,09	44,09	44,09	49,21	49,21	49,21
I ₂	[pulgadas/inch/pouces]	7,48	7,48	7,48	7,48	8,07	8,07	8,07	8,07	7,48	7,48	7,48	8,07	8,07	8,07
I ₃	[pulgadas/inch/pouces]	29,13	29,13	29,13	29,13	33,07	33,07	33,07	33,07	29,13	29,13	29,13	33,07	33,07	33,07
b ₁	[pulgadas/inch/pouces]	14,96	14,96	14,96	14,96	16,93	16,93	16,93	16,93	14,96	14,96	14,96	16,93	16,93	16,93
b ₂	[pulgadas/inch/pouces]	19,29	19,29	19,29	19,29	21,26	21,26	21,26	21,26	19,29	19,29	19,29	21,26	21,26	21,26
b ₃	[pulgadas/inch/pouces]	17,32	17,32	17,32	17,32	19,29	19,29	19,29	19,29	17,32	17,32	17,32	19,29	19,29	19,29
d	[pulgadas/inch/pouces]	0,94	0,94	0,94	0,94	0,94	0,94	0,94	0,94	0,94	0,94	0,94	0,94	0,94	0,94
a ₂	[pulgadas/inch/pouces]	2,95	2,95	2,95	2,95	3,54	3,54	3,54	3,54	3,54	3,54	3,54	3,54	3,54	3,54
h	[pulgadas/inch/pouces]	3,15	3,15	3,15	3,15	3,15	3,15	3,15	3,15	3,15	3,15	3,15	3,15	3,15	3,15
h ₃	[pulgadas/inch/pouces]	10,24	10,24	10,24	10,24	11,02	11,02	11,02	11,02	11,02	11,02	11,02	12,99	12,99	13,78
h ₄	[pulgadas/inch/pouces]	16,38	16,38	17,56	17,56	18,35	18,35	18,35	19,76	18,35	18,35	18,35	20,31	21,7	22,52
Typo de bancada numero Base frame type no. Numéro du type d'armature		5	5	5	5	6	6	6	6	5	5	5	6	6	7
Peso neto Net weight Poids net	[lbs]	291	295	372	381	417	426	430	482	390	398	403	459	510	592
Peso bruto Gross weight Poids brut	[lbs]	460	464	541	550	655	664	668	720	559	567	572	667	748	830
Volumen bruto Gross volume Volume brut	[ft ³]	22,70	22,70	22,70	22,70	38,10	38,10	38,10	38,10	22,70	22,70	22,70	38,10	38,10	38,10

P ₂	[HP] [kW]	GBS 80-400			GBS 100-200			GBS 100-250			GBS 100-315		
		15	20	25	2	3	4	4	5	7,5	7,5	10	15
Carcasa/Frame/Armature		284T	286T	324T	184T	213T	215T	215T	215T	254T	254T	256T	284T
ANSI	[psi]	125	125	125	125	125	125	125	125	125	125	125	125
DN _S	[pulgadas/inch/pouces]	4,00	4,00	4,00	5,00	5,00	5,00	5,00	5,00	5,00	5,00	5,00	5,00
DN _d	[pulgadas/inch/pouces]	3,00	3,00	3,00	4,00	4,00	4,00	4,00	4,00	4,00	4,00	4,00	4,00
a	[pulgadas/inch/pouces]	5,51	5,51	5,51	4,92	4,92	4,92	5,51	5,51	5,51	5,51	5,51	5,51
h ₂	[pulgadas/inch/pouces]	13,98	13,98	13,98	11,02	11,02	11,02	11,02	11,02	11,02	11,02	12,40	12,40
L	[pulgadas/inch/pouces]	55,67	56,42	58,90	40,20	43,94	44,09	44,69	44,69	48,07	48,07	49,72	53,31
I ₁	[pulgadas/inch/pouces]	62,99	62,99	62,99	44,09	44,09	44,09	49,21	49,21	49,21	49,21	49,21	55,12
I ₂	[pulgadas/inch/pouces]	10,63	10,63	10,63	7,48	7,48	7,48	8,07	8,07	8,07	8,07	9,06	9,06
I ₃	[pulgadas/inch/pouces]	41,73	41,73	41,73	29,13	29,13	29,13	33,07	33,07	33,07	33,07	37,01	37,01
b ₁	[pulgadas/inch/pouces]	20,87	20,87	20,87	14,96	14,96	14,96	16,93	16,93	16,93	16,93	18,90	18,90
b ₂	[pulgadas/inch/pouces]	25,98	25,98	25,98	19,29	19,29	19,29	21,26	21,26	21,26	21,26	24,02	24,02
b ₃	[pulgadas/inch/pouces]	23,62	23,62	23,62	17,32	17,32	17,32	19,29	19,29	19,29	19,29	21,65	21,65
d	[pulgadas/inch/pouces]	1,10	1,10	1,10	0,94	0,94	0,94	0,94	0,94	0,94	0,94	1,10	1,10
a ₂	[pulgadas/inch/pouces]	4,33	4,33	4,33	3,54	3,54	3,54	3,54	3,54	3,54	3,54	3,54	3,54
h	[pulgadas/inch/pouces]	3,94	3,94	3,94	3,15	3,15	3,15	3,15	3,15	3,15	3,15	3,94	3,94
h ₃	[pulgadas/inch/pouces]	14,96	14,96	14,96	11,02	11,02	11,02	12,01	12,01	12,01	12,01	13,78	13,78
h ₄	[pulgadas/inch/pouces]	24,49	24,49	25,08	17,17	18,35	18,35	19,33	19,33	20,75	21,73	22,52	23,31
Typo de bancada numero Base frame type no. Numéro du type d'armature		8	8	8	5	5	5	6	6	6	6	7	7
Peso neto Net weight Poids net	[lbs]	902	963	1078	319	396	405	443	448	499	530	612	782
Peso bruto Gross weight Poids brut	[lbs]	1195	1256	1371	488	565	574	681	686	737	768	850	1020
Volumen bruto Gross volume Volume brut	[ft ³]	52,05	52,05	52,05	22,70	22,70	22,70	38,10	38,10	38,10	38,10	38,10	38,10

Nota: Todas las medidas estan basadas con acoplamiento estandar, las dimensiones cambian con el acoplamiento espaciador.

Note: All dimensions are based on standard coupling, dimensions will change for spacer coupling.

Note: Toutes les dimensions sont fondées sur la norme coupling, les dimensions changeront pour l'entretoise coupling.



GENERAL PUMPS

Dimensiones y pesos
Dimensions and Weights
Dimensions et poids

1150

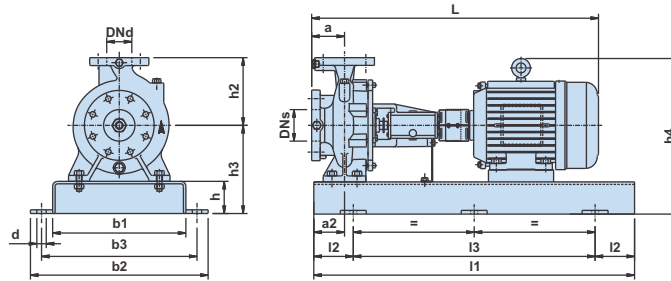

	GBS 100-400				GBS 125-250			GBS 125-315			GBS 125-400				GBS 125-500				
P₂	[HP]	15	20	25	30	5	7,5	10	10	15	20	25	30	40	50	40	50	60	75
	[kW]	11	15	18,5	22	3,7	5,5	7,5	7,5	11	15	18,5	22	30	37	30	37	45	55
Carcasa/Frame/Armature		284T	286T	324T	326T	215T	254T	256T	256T	284T	286T	324T	326T	364T	365T	364T	365T	404T	404T
ANSI	[psi]	125	125	125	125	125	125	125	125	125	125	125	125	125	125	125	125	125	125
DN_s	[pulgadas/inch/pouces]	5,00	5,00	5,00	5,00	6,00	6,00	6,00	6,00	6,00	6,00	6,00	6,00	6,00	6,00	6,00	6,00	6,00	6,00
DN_d	[pulgadas/inch/pouces]	4,00	4,00	4,00	4,00	5,00	5,00	5,00	5,00	5,00	5,00	5,00	5,00	5,00	5,00	5,00	5,00	5,00	5,00
a	[pulgadas/inch/pouces]	5,51	5,51	5,51	5,51	5,51	5,51	5,51	5,51	5,51	5,51	5,51	5,51	5,51	5,51	5,51	5,51	7,09	7,09
h₂	[pulgadas/inch/pouces]	13,98	13,98	13,98	13,98	13,98	13,98	13,98	13,98	13,98	13,98	15,75	15,75	15,75	15,75	15,75	15,75	19,69	19,69
L	[pulgadas/inch/pouces]	55,67	56,42	58,90	58,90	44,69	48,07	49,72	52,09	55,67	56,42	58,90	58,90	60,00	60,98	67,09	68,07	72,13	72,13
l₁	[pulgadas/inch/pouces]	62,99	62,99	62,99	62,99	49,21	49,21	55,12	62,99	62,99	62,99	62,99	62,99	62,99	62,99	78,74	78,74	78,74	78,74
l₂	[pulgadas/inch/pouces]	10,63	10,63	10,63	10,63	8,07	8,07	9,06	10,63	10,63	10,63	10,63	10,63	10,63	10,63	12,99	12,99	12,99	12,99
l₃	[pulgadas/inch/pouces]	41,73	41,73	41,73	41,73	33,07	33,07	37,01	41,73	41,73	41,73	41,73	41,73	41,73	41,73	52,76	52,76	52,76	52,76
b₁	[pulgadas/inch/pouces]	20,87	20,87	20,87	20,87	16,93	16,93	18,90	20,87	20,87	20,87	20,87	20,87	20,87	20,87	29,53	29,53	29,53	29,53
b₂	[pulgadas/inch/pouces]	25,98	25,98	25,98	25,98	21,26	21,26	24,02	25,98	25,98	25,98	25,98	25,98	25,98	25,98	35,04	35,04	35,04	35,04
b₃	[pulgadas/inch/pouces]	23,62	23,62	23,62	23,62	19,29	19,29	21,65	23,62	23,62	23,62	23,62	23,62	23,62	23,62	32,68	32,68	32,68	32,68
d	[pulgadas/inch/pouces]	1,10	1,10	1,10	1,10	0,94	0,94	1,10	1,10	1,10	1,10	1,10	1,10	1,10	1,10	1,10	1,10	1,10	1,10
a₂	[pulgadas/inch/pouces]	4,33	4,33	4,33	4,33	3,54	3,54	3,54	4,33	4,33	4,33	4,33	4,33	4,33	4,33	4,33	4,33	4,33	4,33
h	[pulgadas/inch/pouces]	3,94	3,94	3,94	3,94	3,15	3,15	3,94	3,94	3,94	3,94	3,94	3,94	3,94	3,94	5,12	5,12	5,12	5,12
h₃	[pulgadas/inch/pouces]	14,96	14,96	14,96	14,96	12,99	12,99	13,78	14,96	14,96	14,96	16,34	16,34	16,34	16,34	20,87	20,87	20,87	20,87
h₄	[pulgadas/inch/pouces]	24,49	24,49	25,08	25,08	20,31	21,73	22,52	23,70	24,49	24,49	26,46	26,46	27,52	27,52	32,48	32,91	32,91	33,78
Tipo de bancada numero Base frame type no. Numéro du type d'armature		8	8	8	8	6	6	7	8	8	8	8	8	8	8	10	10	10	10
Peso neto Net weight Poids net	[lbs]	902	963	1078	1103	507	559	640	725	895	956	1151	1176	1317	1403	2127	2213	2466	2508
Peso bruto Gross weight Poids brut	[lbs]	1195	1256	1371	1396	745	797	878	1018	1188	1249	1444	1469	1610	1696	2677	2763	3016	3058
Volumen bruto Gross volume Volume brut	[ft ³]	52,05	52,05	52,05	52,05	38,10	38,10	38,10	52,05	52,05	52,05	52,05	52,05	52,05	52,05	107,18	107,18	107,18	107,18

	GBS 150-250			GBS 150-315				GBS 150-400					
P₂	[HP]	7,5	10	15	15	20	25	30	30	40	50	60	
	[kW]	5,5	7,5	11	11	15	18,5	22	22	30	37	45	
Carcasa/Frame/Armature		254T	256T	284T	284T	286T	324T	326T	326T	364T	365T	404T	
ANSI	[psi]	125	125	125	125	125	125	125	125	125	125	125	
DN_s	[pulgadas/inch/pouces]	8,00	8,00	8,00	8,00	8,00	8,00	8,00	8,00	8,00	8,00	8,00	
DN_d	[pulgadas/inch/pouces]	6,00	6,00	6,00	6,00	6,00	6,00	6,00	6,00	6,00	6,00	6,00	
a	[pulgadas/inch/pouces]	6,30	6,30	6,30	6,30	6,30	6,30	6,30	6,30	6,30	6,30	6,30	
h₂	[pulgadas/inch/pouces]	14,76	14,76	14,76	15,75	15,75	15,75	15,75	17,72	17,72	17,72	17,72	
L	[pulgadas/inch/pouces]	50,55	52,20	55,67	56,46	57,20	59,69	59,69	59,69	60,79	61,77	65,83	
l₁	[pulgadas/inch/pouces]	62,99	62,99	62,99	70,87	70,87	70,87	70,87	70,87	70,87	70,87	70,87	
l₂	[pulgadas/inch/pouces]	10,63	10,63	10,63	11,81	11,81	11,81	11,81	11,81	11,81	11,81	11,81	
l₃	[pulgadas/inch/pouces]	41,73	41,73	41,73	47,24	47,24	47,24	47,24	47,24	47,24	47,24	47,24	
b₁	[pulgadas/inch/pouces]	20,87	20,87	20,87	23,62	23,62	23,62	23,62	23,62	23,62	23,62	23,62	
b₂	[pulgadas/inch/pouces]	25,98	25,98	25,98	28,74	28,74	28,74	28,74	28,74	28,74	28,74	28,74	
b₃	[pulgadas/inch/pouces]	23,62	23,62	23,62	26,38	26,38	26,38	26,38	26,38	26,38	26,38	26,38	
d	[pulgadas/inch/pouces]	1,10	1,10	1,10	1,10	1,10	1,10	1,10	1,10	1,10	1,10	1,10	
a₂	[pulgadas/inch/pouces]	4,33	4,33	4,33	4,33	4,33	4,33	4,33	4,33	4,33	4,33	4,33	
h	[pulgadas/inch/pouces]	3,94	3,94	3,94	3,94	3,94	3,94	3,94	3,94	3,94	3,94	3,94	
h₃	[pulgadas/inch/pouces]	14,96	14,96	14,96	14,96	14,96	14,96	14,96	16,34	16,34	16,34	16,34	
h₄	[pulgadas/inch/pouces]	24,53	24,53	26,54	24,49	24,49	25,08	25,08	24,46	27,52	27,52	28,82	
Tipo de bancada numero Base frame type no. Numéro du type d'armature		8	8	8	9	9	9	9	9	9	9	9	
Peso neto Net weight Poids net	[lbs]	697	725	895	988	1048	1164	1189	1262	1403	1488	1742	
Peso bruto Gross weight Poids brut	[lbs]	985	1013	1184	1340	1400	1516	1541	1614	1755	1840	2094	
Volumen bruto Gross volume Volume brut	[ft ³]	51,27	51,27	51,27	68,78	68,78	68,78	68,78	68,78	68,78	68,78	68,78	

Nota: Todas las medidas estan basadas con acoplamiento estandar, las dimensiones cambian con el acoplamiento espaciador.

Note: All dimensions are based on standard coupling, dimensions will change for spacer coupling.

Note: Toutes les dimensions sont fondées sur la norme coupling, les dimensions changeront pour l'entretoise coupling.

Bancadas

Base Frames

Base d'armature

Los bocetos tridimensionales a continuación muestran las dimensiones de los bancada de las bombas GBS.

The dimensional sketches below show the dimensions of the base frames fitted to GBS pumps.

Les croquis dimensionnels ci-dessous montrent les dimensions des bâtis adaptés aux pompes de GBS.

El número del tipo de bancada se establece en cada bomba GBS mencionada en las Dimensiones y pesos.

The type number of the base frame is stated for each GBS pump mentioned in the Dimensions and weights.

Le type nombre du bâti est énoncé pour chaque pompe de GBS mentionnée dans les dimensions et les poids.

Tipo de bancada numero Base frame type no. Numéro du type d'armature	Bancada Base frame Armature
2	
3	
4	
5	
6	

Tipo de bancada numero Base frame type no. Numéro du type d'armature	Bancada Base frame Armature
7	
8	
9	
10	

Nota: Todas las medidas en pulgadas, salvo que se indique lo contrario.

Note: All dimensions in inches unless otherwise noted.

Note: Toutes les dimensions en pouces sauf indication contraire.

Contra-bridas

Counter Flanges

Contre- brides

Bombas de hierro fundido (versión A, B, C, D)

Para conexiones de rosca, las bridas están hechas de hierro fundido. Para conexiones de brida, las bridas son de acero al carbono.

Bombas de CF-8 y de Bronce (versión E, F)

Para conexiones de rosca, las bridas están hechas de CF-8. Para las conexiones de brida, las bridas están hechas de acero inoxidable AISI 304.

Bombas CF-8M (versión-G)

Para conexiones de rosca, las bridas están hechas de CF-8M. Para conexiones de brida, las bridas son de acero inoxidable AISI 316.

Conjunto compuesto por una contra-bridas, una junta de material engomado y el número requerido de pernos y tuercas.

Cast iron pumps (version-A,B,C,D)

For threaded connection, flanges are made of cast iron. For welding connection, flanges are made of carbon steel.

CF-8 & Bronze pumps (version-E,F)

For threaded connection, flanges are made of CF-8. For welding connection, flanges are made of stainless steel AISI 304.

CF-8M pumps (version-G)

For threaded connection, flanges are made of CF-8M. For welding connection, flanges are made of stainless steel AISI 316.

A set consist of one counter flange, one gasket of rubber material and the requisite number of bolts and nuts.

Pompes de fer de fonte (version-A, B, C, D)

Pour le raccordement fileté, des brides sont faites de fer de fonte. Pour le raccordement de soudure, des brides sont faites d'acier du carbone.

CF-8 et les pompes en bronze (version-E, F)

Pour le raccordement fileté, des brides sont faites de CF-8. Pour le raccordement de soudure, des brides sont faites d'acier inoxydable AISI 304.

CF-8M pompe (version-G)

Pour le raccordement fileté, des brides sont faites de CF-8M. Pour le raccordement de soudure, des brides sont faites d'acier inoxydable AISI 316.

Un ensemble se compose d'une contre- bride, d'une garniture de matériel en caoutchouc et du nombre requis de boulons et d'écrous

Contra-bridas Counter flange Contre- bride	Tamaño de la bridas Flange size Taille de bride	Descripción Description Description		A	B	C	OD x N° de orificios	Conexión de tuberías Pipework connection Raccordement de canalisation	Número del producto				
							ØD x Nos. of holes		Product number				
							ØD x Nombre de trous		Nombre de produit				
	1 1/4	En rosca Threaded Fileté	ANSI 125	Ø4,53	Ø3,50	-	Ø0,62X4	1 1/4" NPT	GF0323T*				
			ANSI 250	Ø5,31	Ø3,86	Ø3,07	Ø0,75X4		GF0324T*				
			PN 16	Ø5,51	Ø3,94	Ø3,07	Ø0,70X4	1 1/4" BSP**	GF0321T*				
			PN 25	Ø5,51	Ø3,94	Ø3,07	Ø0,70X4		GF0322T*				
			De brida For welding Pour la soudure	ANSI 125	Ø4,53	Ø3,50	-	Ø0,62X4	1 1/4"	GF0323W*			
				ANSI 250	Ø5,31	Ø3,86	Ø3,07	Ø0,75X4		GF0324W*			
		PN 16		Ø5,51	Ø3,94	Ø3,07	Ø0,70X4	GF0321W*					
		PN 25		Ø5,51	Ø3,94	Ø3,07	Ø0,70X4	GF0322W*					
		ANSI 125		Ø4,92	Ø3,86	-	Ø0,62X4	1 1/2" NPT		GF0403T*			
		ANSI 250		Ø6,10	Ø4,49	Ø3,58	Ø0,87X4			GF0404T*			
		PN 16	Ø5,91	Ø4,33	Ø3,46	Ø0,70X4	1 1/2" BSP**		GF0401T*				
		PN 25	Ø5,91	Ø4,33	Ø3,46	Ø0,70X4			GF0402T*				
	1 1/2	En rosca Threaded Fileté	ANSI 125	Ø4,92	Ø3,86	-	Ø0,62X4	1 1/2" NPT	GF0403T*				
			ANSI 250	Ø6,10	Ø4,49	Ø3,58	Ø0,87X4		GF0404T*				
			PN 16	Ø5,91	Ø4,33	Ø3,46	Ø0,70X4	1 1/2" BSP**	GF0401T*				
			PN 25	Ø5,91	Ø4,33	Ø3,46	Ø0,70X4		GF0402T*				
			De brida For welding Pour la soudure	ANSI 125	Ø4,92	Ø3,86	-	Ø0,62X4	1 1/2"	GF0403W*			
				ANSI 250	Ø6,10	Ø4,49	Ø3,58	Ø0,87X4		GF0404W*			
		PN 16		Ø5,91	Ø4,33	Ø3,46	Ø0,70X4	GF0401W*					
		PN 25		Ø5,91	Ø4,33	Ø3,46	Ø0,70X4	GF0402W*					
				2	En rosca Threaded Fileté	ANSI 125	Ø5,91	Ø4,76		-	Ø0,75X4	2" NPT	GF0503T*
						ANSI 250	Ø6,50	Ø5,00		Ø4,17	Ø0,75X8		GF0504T*
			PN 16			Ø6,50	Ø4,92	Ø4,02	Ø0,70X4	2" BSP**	GF0501T*		
			PN 25			Ø6,50	Ø4,92	Ø4,02	Ø0,70X4		GF0502T*		
De brida For welding Pour la soudure	ANSI 125		Ø5,91			Ø4,76	-	Ø0,75X4	2"	GF0503W*			
	ANSI 250		Ø6,50			Ø5,00	Ø4,17	Ø0,75X8		GF0504W*			
	PN 16		Ø6,50		Ø4,92	Ø4,02	Ø0,70X4	GF0501W*					
	PN 25		Ø6,50		Ø4,92	Ø4,02	Ø0,70X4	GF0502W*					
			2 1/2		En rosca Threaded Fileté	ANSI 125	Ø7,09	Ø5,51		-	Ø0,75X4	2 1/2" NPT	GF0653T*
						ANSI 250	Ø7,48	Ø5,87		Ø4,92	Ø0,87X8		GF0654T*
PN 16						Ø7,28	Ø5,71	Ø4,80	Ø0,70X4	2 1/2" BSP**	GF0651T*		
PN 25						Ø7,28	Ø5,71	Ø4,80	Ø0,70X8		GF0652T*		
De brida For welding Pour la soudure		ANSI 125		Ø7,09		Ø5,51	-	Ø0,75X4	2 1/2"	GF0653W*			
		ANSI 250		Ø7,48		Ø5,87	Ø4,92	Ø0,87X8		GF0654W*			
		PN 16		Ø7,28	Ø5,71	Ø4,80	Ø0,70X4	GF0651W*					
		PN 25		Ø7,28	Ø5,71	Ø4,80	Ø0,70X8	GF0652W*					

Contra-bridas

Counter Flanges

Contre- brides

Contra-bridas Counter flange Contre- bride	Tamaño de la bridas Flange size Taille de bride	Descripción Description Description		A	B	C	OD x N ° de orificios ØD x Nos. of holes ØD x Nombre de trous	Conexión de tuberías Pipework connection Raccordement de canalisation	Número del producto Product number Nombre de produit
	3	En rosca Threaded Fileté	ANSI 125	Ø7,48	Ø5,98	-	Ø0,75X4	3" NPT	GF0803T*
			ANSI 250	Ø8,27	Ø6,61	Ø5,67	Ø0,87X8		GF0804T*
			PN 16	Ø7,87	Ø6,30	Ø5,43	Ø0,70X8	3" BSP**	GF0801T*
		De brida For welding Pour la soudure	ANSI 125	Ø7,48	Ø5,98	-	Ø0,75X4	3"	GF0803W*
			ANSI 250	Ø8,27	Ø6,61	Ø5,67	Ø0,87X8		GF0804W*
			PN 16	Ø7,87	Ø6,30	Ø5,43	Ø0,70X8		GF0801W*
			PN 25	Ø7,87	Ø6,30	Ø5,43	Ø0,70X8	GF0802W*	
	4	En rosca Threaded Fileté	ANSI 125	Ø9,06	Ø7,52	-	Ø0,75X8	4" NPT	GF1003T*
			ANSI 250	Ø10,04	Ø7,87	Ø6,93	Ø0,87X8		GF1004T*
			PN 16	Ø9,25	Ø7,09	Ø6,22	Ø0,70X8	4" BSP**	GF1001T*
		De brida For welding Pour la soudure	PN 25	Ø9,25	Ø7,48	Ø6,22	Ø0,86X8	4"	GF1002T*
			ANSI 125	Ø9,06	Ø7,52	-	Ø0,75X8		GF1003W*
			ANSI 250	Ø10,04	Ø7,87	Ø6,93	Ø0,87X8		GF1004W*
			PN 16	Ø9,25	Ø7,09	Ø6,22	Ø0,70X8	GF1001W*	
			PN 25	Ø9,25	Ø7,48	Ø6,22	Ø0,86X8	GF1002W*	
	5	En rosca Threaded Fileté	ANSI 125	Ø10,04	Ø8,50	-	Ø0,87X8	5" NPT	GF1253T*
			ANSI 250	Ø11,02	Ø9,25	Ø8,31	Ø0,87X8		GF1254T*
			PN 16	Ø10,63	Ø8,27	Ø7,40	Ø0,70X8	5" BSP**	GF1251T*
		De brida For welding Pour la soudure	PN 25	Ø10,63	Ø8,66	Ø7,40	Ø0,98X8	5"	GF1252T*
			ANSI 125	Ø10,04	Ø8,50	-	Ø0,87X8		GF1253W*
			ANSI 250	Ø11,02	Ø9,25	Ø8,31	Ø0,87X8		GF1254W*
			PN 16	Ø10,63	Ø8,27	Ø7,40	Ø0,70X8	GF1251W*	
			PN 25	Ø10,63	Ø8,66	Ø7,40	Ø0,98X8	GF1252W*	
	6	En rosca Threaded Fileté	ANSI 125	Ø11,02	Ø9,49	-	Ø0,87X8	6" NPT	GF1503T*
			ANSI 250	Ø12,60	Ø10,63	Ø9,69	Ø0,87X12		GF1504T*
			PN 16	Ø11,81	Ø9,45	Ø8,35	Ø0,86X8	6" BSP**	GF1501T*
		De brida For welding Pour la soudure	PN 25	Ø11,81	Ø9,84	Ø8,35	Ø0,98X8	6"	GF1502T*
			ANSI 125	Ø11,02	Ø9,49	-	Ø0,87X8		GF1503W*
			ANSI 250	Ø12,60	Ø10,63	Ø9,69	Ø0,87X12		GF1504W*
			PN 16	Ø11,81	Ø9,45	Ø8,35	Ø0,86X8	GF1501W*	
			PN 25	Ø11,81	Ø9,84	Ø8,35	Ø0,98X8	GF1502W*	
	8	En rosca Threaded Fileté	ANSI 125	Ø13,58	Ø11,77	-	Ø0,87X8	8" NPT	GF2003T*
			ANSI 250	Ø14,96	Ø12,99	Ø11,93	Ø1,13X12		GF2004T*
			PN 16	Ø14,17	Ø11,61	Ø10,55	Ø0,86X12	8" BSP**	GF2001T*
		De brida For welding Pour la soudure	PN 25	Ø14,17	Ø12,20	Ø10,55	Ø0,98X12	8"	GF2002T*
			ANSI 125	Ø13,58	Ø11,77	-	Ø0,87X8		GF2003W*
			ANSI 250	Ø14,96	Ø12,99	Ø11,93	Ø1,13X12		GF2004W*
			PN 16	Ø14,17	Ø11,61	Ø10,55	Ø0,86X12	GF2001W*	
			PN 25	Ø14,17	Ø12,20	Ø10,55	Ø0,98X12	GF2002W*	
	10	En rosca Threaded Fileté	ANSI 125	Ø15,94	Ø14,25	-	Ø1X12	10" NPT	GF2503T*
			ANSI 250	Ø17,52	Ø15,24	Ø14,06	Ø1,25X16		GF2504T*
			PN 16	Ø16,73	Ø13,98	Ø12,60	Ø0,98X12	10" BSP**	GF2501T*
		De brida For welding Pour la soudure	PN 25	Ø16,73	Ø14,57	Ø12,60	Ø1,14X12	10"	GF2502T*
			ANSI 125	Ø15,94	Ø14,25	-	Ø1X12		GF2503W*
			ANSI 250	Ø17,52	Ø15,24	Ø14,06	Ø1,25X16		GF2504W*
			PN 16	Ø16,73	Ø13,98	Ø12,60	Ø0,98X12	GF2501W*	
			PN 25	Ø16,73	Ø14,57	Ø12,60	Ø1,14X12	GF2502W*	

Nota: * Agregar un subíndice según el siguiente ejemplo de la pieza numero.
 GF0321TCI para bridas de hierro fundido.
 GF0321TS1 para bridas de acero inoxidable AISI 304.
 GF0321TS2 para bridas de acero inoxidable AISI 316.
 GF0321WCS para bridas de acero al carbono.
 ** Bidas NPT también disponibles por encargo.
 Todas las medidas en pulgadas, salvo que se indique lo contrario.

Note: * Add a subscript as per following example to product number.
 GF0321TCI for cast iron flanges.
 GF0321TS1 for stainless steel AISI 304 flanges.
 GF0321TS2 for stainless steel AISI 316 flanges.
 GF0321WCS for carbon steel flanges.
 ** NPT threaded flanges are also available on request.
 All dimensions in inches unless otherwise noted.

Note: * Ajoutez un indice inférieur selon l'exemple suivant la partie #.
 GF0321TCI pour des brides de fer de fonte.
 GF0321TS1 pour des brides de l'acier inoxydable AISI 304.
 GF0321TS2 pour des brides de l'acier inoxydable AISI 316.
 GF0321WCS pour des brides d'acier du carbone
 ** Les brides filetéés par TNP sont également disponibles sur demande.
 Toutes les dimensions en pouces sauf indication contraire.





GENERAL PUMPS

GENERAL PUMPS, S.L.

Pol. Ind. El Oliveral (U.E.7, Nave nº1) - Calle W
46394 Ribarroja del Turia - Valencia Spain
Tel. : +34 96 1665200 / Fax :+34 96 1665052
E-mail: info@pumpsgp.com • www.pumpsgp.com

01.00.011216.0090