

CE

IE 1 / IE 2 / IE 3



GENERAL PUMPS



GMT Series

Energy-efficient
Cast Iron Three Phase
Induction Motors

50 Hz.

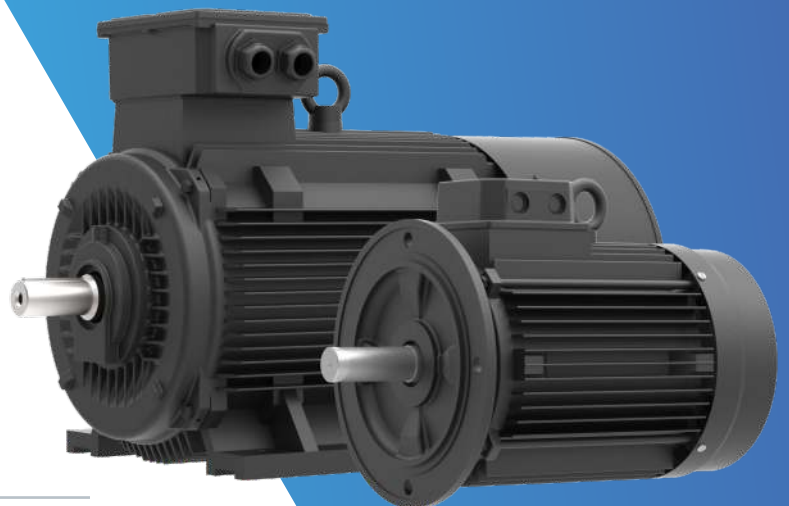

www.pumpsgp.com

Contents

SPECIFICATIONS	Page 3
APPLICATIONS	Page 4
FEATURES AND BENEFITS	Page 4
BENEFITS OF ENERGY EFFICIENT MOTORS	Page 4
STANDARDS FOR MOTORS	Page 5
INTERNATIONAL STANDARDS FOR MOTOR EFFICIENCY	Page 6
NOMINAL EFFICIENCY OF MOTORS & EFFICIENCY CLASS COMPARISON	Page 7
TOLERANCES	Page 8
TYPE KEY	Page 9
MATERIAL OF CONSTRUCTION	Page 9
MOUNTING ARRANGEMENTS	Page 10
DEGREE OF PROTECTION (INGRESS PROTECTION - IP)	Page 11
INSULATION CLASS	Page 12
EFFECTS OF VARIATION OF VOLTAGE AND FREQUENCY	Page 12
OVERLOAD	Page 12
INSTALLATION CONDITIONS	Page 13
INSTALLATION AT ALTITUDES OF MORE THAN 1000 M ABOVE SEA LEVEL	Page 13
NUMBERS OF STARTS/HOUR	Page 13
BEARING DETAILS & LUBRICATION	Page 14
TERMINAL BOX	Page 14
CABLE SIZE	Page 14
NOISE LEVEL	Page 15
VIBRATION LEVEL	Page 15
EXPLODED VIEW AND SPARE PARTS DESCRIPTION	Page 16
MOTOR PERFORMANCE DATA	Page 17
MOTOR DIMENSIONAL DRAWING	Page 27
SHIPPING DIMENSIONS	Page 33



Product Data

SPECIFICATIONS

- Motor type : AC three-phase squirrel cage induction motor
- Enclosure : TEFC
- Frame : 63 to 355L
- Mounting : Foot, Flange and Face
- Rated power : 0.18 kW to 315 kW (0.25 to 430 HP)
- Voltage \pm variation : 415 V \pm 10%
- Frequency \pm variation: 50 Hz \pm 5%
- Combined variation : 10% (Absolute sum)
- Rated speed : 3000, 1500, 1000, 750 rpm (2 pole, 4 pole, 6 pole, 8 pole)
- Ambient temperature : +50°C
- Altitude : Should be lower than 1000 metres above sea level
- Relative humidity : Up to 100%
- Connection : Up to 2.2 kW-Star connection with 3 leads & above 2.2 kW-Delta connection with 6 leads
- Direction of rotation : Anticlockwise or clockwise as seen from the Driver end side
- Duty / Rating : S1 / Continuous
- Insulation class : Class 'F' and temperature rise limited to class 'B'
- Degree of protection : IP 55
- Cooling method : IC411 / Shaft mounted fan.

Product Data

APPLICATIONS

- Pumps
- Compressors
- Fans and blowers
- Flour mills, rolling mills, mixers
- Machine tools
- Textile and plastic machineries
- Printing, packaging and wood working machineries
- Agricultural, food processing machinery
- Material handling equipments
- Cranes, hoists and lifts
- Cooling towers.

FEATURES AND BENEFITS

- Motors are fitted with dynamically balanced aluminium die cast squirrel cage rotors.
- Motors are fitted with pre-lubricated antifriction ball bearings up to 132 frame.
- Motors are free from moisture and dust particles.
- Minimum electricity consumption because of special grade electrical steel used in an energy efficient optimized design.
- Balanced three-dimensional heat transfer principal due to special fins design of stator body.
- Minimum rotor losses due to use of electrolytic grade of aluminium.
- Minimum copper losses due to use of electrolytic grade of copper.
- Minimum friction losses.
- Low noise, smooth running motor.
- Reliable operation.
- Easy maintenance.
- Low payback period.

BENEFITS OF ENERGY EFFICIENT MOTORS

- Short payback period / lower operating cost due to their higher efficiency.
- Motors have lower power dissipation due to their higher efficiency.
- Motors have a longer life span due to their relatively low temperature rise.
- Motors have higher thermal margins, which helps avoid unnecessary safety margins in the design process.
- Motors save energy and reduce CO₂ emissions.

STANDARDS FOR MOTORS

All motors are complying with following International standards:

<i>International Standards</i>	
IEC 60034-1	Rating and performance
IEC 60034-2-1	Methods for determining losses and efficiency
IEC 60034-5	Classification of degrees of protection
IEC 60034-6	Methods of cooling
IEC 60034-7	Symbols of construction and mounting arrangements
IEC 60034-8	Terminal markings and direction of rotation
IEC 60034-9	Noise limits
IEC 60072-1	Dimensions and output of electric machines
IEC 60034-14	Vibration limits
IEC 60034-30-1	Efficiency classes of line operated AC motors (IE code)

INTERNATIONAL STANDARDS FOR MOTOR EFFICIENCY

The efficiency factor defines the efficiency of motors when transforming electrical energy into mechanical energy.

The International Electrotechnical Commission (IEC), in order to harmonize the energy consumption regulations aimed to reduce the CO₂ emissions and the impact of industrial operations on the environment, has established the standard IEC 60034-30:2008 which defines energy efficiency classes for low-voltage, three-phase, 50Hz and 60Hz squirrel cage induction motors.

In parallel IEC developed and issued a new standard for determining the motor efficiencies. The new standard IEC 60034-30 defines and harmonizes worldwide the efficiency classes IE1, IE2 and IE3 for low-voltage three-phase motors in the power range from 0.75 kW to 375 kW.

New international efficiency classes of low-voltage three-phase motors - IE = International Efficiency

The new IEC 60034-30:2008 defines worldwide the following efficiency classes of LV three-phase motors, in the range from 0.75 to 375 kW.

IE1 = Standard Efficiency

IE2 = High Efficiency

IE3 = Premium Efficiency

(new efficiency class in Europe nowadays and identical to "NEMA Premium" in the USA for 60Hz).

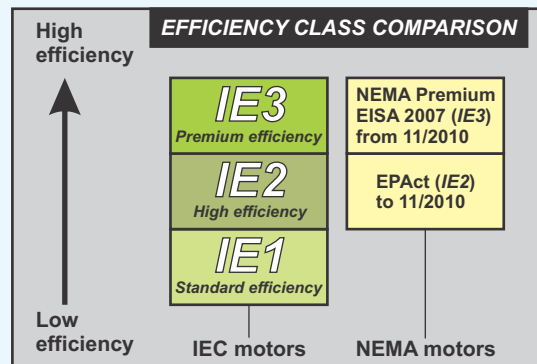

From now motors can be offered and sold with the new classes IE1, IE2 and IE3.

In that case the efficiency has to be determined according to the new requirements given in the IEC 60034-2-1 standard.

According to the Commission Regulation (EC) No 640/2009 (introduced in July 2009) the required efficiency class of general-purpose motors (introduced to the market in Europe in future) will be as follows:

- ★ From 16 June 2011, motors placed for the first-time on the market shall have a minimum efficiency class of IE2.
- ★ From 1 January 2015: motors with a rated output between 7.5 - 375 kW shall have a minimum efficiency class of IE3, or IE2 if they are operated/equipped with electronic speed control (VSD).
- ★ From 1 January 2017: motors with a rated output between 0.75 - 375 kW shall have a minimum efficiency class of IE3, or IE2 if they are operated/equipped with electronic speed control (VSD).

Electronic speed control is carried out using a frequency converter (VSD) that adjusts the speed of the motor - and therefore the torque produced - based on the energy needed.

General Pumps has offered energy efficiency motors for several years now. These motors are also in compliance with the efficiency standards covered by CEMEP. We continuously carry out intensive research and development of the motors according to the new standards IEC 60034-30 and IEC 60034-2-1.

Product Data

NOMINAL EFFICIENCY OF MOTORS & EFFICIENCY CLASS COMPARISON

Nominal efficiency (%) limits for class IE1, IE2 & IE3 50 Hz according to the IEC 60034-30										
P _N		2-Pole Eff. (%)			4-Pole Eff. (%)			6-Pole Eff. (%)		
kW	HP	IE1	IE2	IE3	IE1	IE2	IE3	IE1	IE2	IE3
0.75	1	72.1	77.4	80.7	72.1	79.6	82.5	70.0	75.9	78.9
1.1	1.5	75.0	79.6	82.7	75.0	81.4	84.1	72.9	78.1	81.0
1.5	2	77.2	81.3	84.2	77.2	82.8	85.3	75.2	79.8	82.5
2.2	3	79.7	83.2	85.9	79.7	84.3	86.7	77.7	81.8	84.3
3.7	5	82.7	85.5	87.8	82.7	86.3	88.4	80.9	84.3	86.5
5.5	7.5	84.7	87.0	89.2	84.7	87.7	89.6	83.1	86.0	88.0
7.5	10	86.0	88.1	90.1	86.0	88.7	90.4	84.7	87.2	89.1
11	15	87.6	89.4	91.2	87.6	89.8	91.4	86.4	88.7	90.3
15	20	88.7	90.3	91.9	88.7	90.6	92.1	87.7	89.7	91.2
18.5	25	89.3	90.9	92.4	89.3	91.2	92.6	88.6	90.4	91.7
22	30	89.9	91.3	92.7	89.9	91.6	93.0	89.2	90.9	92.2
30	40	90.7	92.0	93.3	90.7	92.3	93.6	90.2	91.7	92.9
37	50	91.2	92.5	93.7	91.2	92.7	93.9	90.8	92.2	93.3
45	60	91.7	92.9	94.0	91.7	93.1	94.2	91.4	92.7	93.7
55	75	92.1	93.2	94.3	92.1	93.5	94.6	91.9	93.1	94.1
75	100	92.7	93.8	94.7	92.7	94.0	95.0	92.6	93.7	94.6
90	120	93.0	94.1	95.0	93.0	94.2	95.2	92.9	94.0	94.9
110	150	93.3	94.3	95.2	93.3	94.5	95.4	93.3	94.3	95.1
132	180	93.5	94.6	95.4	93.5	94.7	95.6	93.5	94.6	95.4
160	215	93.8	94.8	95.6	93.8	94.9	95.8	93.8	94.8	95.6
200 to 375	270 to 500	94.0	95.0	95.8	94.0	95.1	96.0	94.0	95.0	95.8

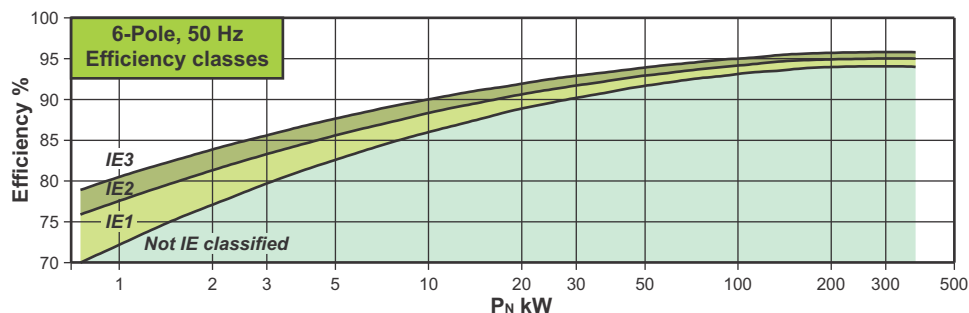
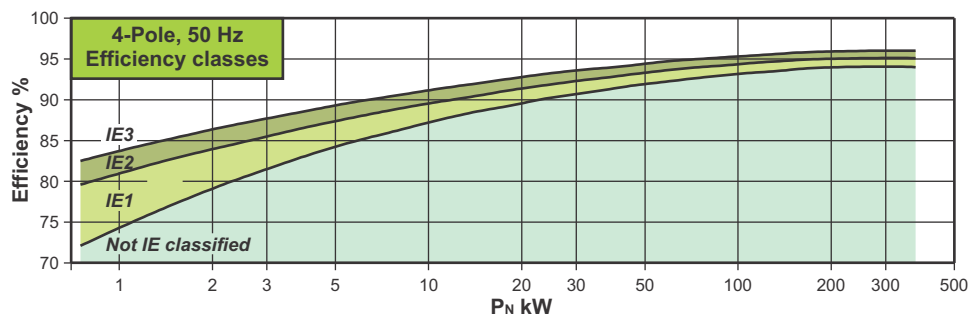
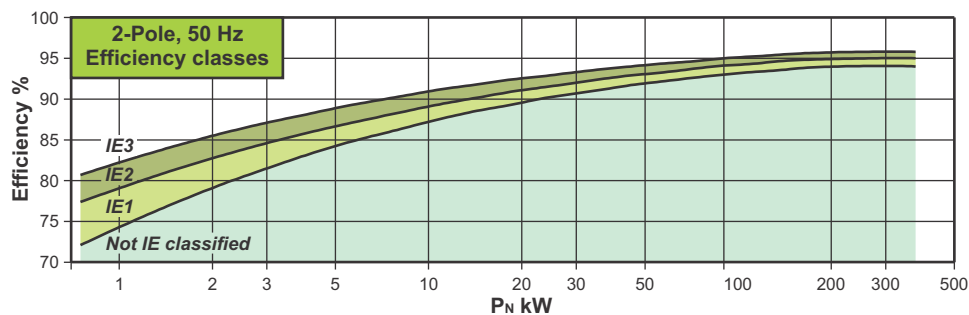

TOLERANCES

For industrial motors according to IEC 60034-1, certain tolerances must be allowed on guaranteed values, taking into consideration the necessary tolerances for the manufacture of such motors and the materials used. The standard includes the following remarks:

- It is not intended that guarantees necessarily have to be given for all or any of the items involved. Quotations including guaranteed values subject to tolerances should say so, and the tolerances should be in accordance with the table.
- Attention is drawn to the different interpretation of the term guarantee. In some countries a distinction is made between guaranteed values and typical or declared values.
- Where a tolerance is stated in only one direction, the value is not limited in the other direction.

Permissible deviation between real values & declared values according to the IEC 60034-1

Power factor ($\cos \varphi$)	-1/6(1-cos φ) Minimum 0.02 and maximum 0.07
Efficiency (η)	-0.15(1- η) for $P_N \leq 150$ kW -0.1(1- η) for $P_N > 150$ kW Where η is a decimal number
Slip (s)	$\pm 20\%$ of the slip for $P_N \geq 1$ kW $\pm 30\%$ of the slip for $P_N < 1$ kW
Locked rotor current (I_L/I_N)	+20% (No lower limit)
Locked rotor torque (T_L/T_N)	-15% and +25% (+25% may be exceeded by agreement)
Breakdown torque (T_B/T_N)	-10%
Moment of inertia (J) [kgm ²]	$\pm 10\%$

Product Data

TYPE KEY

GMT	050	2	112	M	A	2
Type range	Motor output (HP)	Number of poles	Shaft centre height	Mounting arrangements		
GMT = General Pumps Three-phase induction motor series	025 = 0.25 hp 050 = 0.50 hp 075 = 0.75 hp 110 = 1.00 hp 115 = 1.50 hp 120 = 2.00 hp 130 = 3.00 hp 150 = 5.00 hp 175 = 7.50 hp 210 = 10.0 hp 212 = 12.5 hp 215 = 15.0 hp 220 = 20.0 hp 225 = 25.0 hp 230 = 30.0 hp 240 = 40.0 hp 250 = 50.0 hp 260 = 60.0 hp 275 = 75.0 hp 310 = 100 hp 312 = 120 hp 315 = 150 hp 318 = 180 hp 321 = 215 hp 327 = 270 hp 334 = 340 hp 343 = 430 hp	2 = 2 Pole 4 = 4 Pole 6 = 6 Pole 8 = 8 Pole	063 = 63 mm 071 = 71 mm 080 = 80 mm 090 = 90 mm 100 = 100 mm 112 = 112 mm 132 = 132 mm 160 = 160 mm 180 = 180 mm 200 = 200 mm 225 = 225 mm 250 = 250 mm 280 = 280 mm 315 = 315 mm 355 = 355 mm	A = Mounting code IM B3 B = Mounting code IM B34 C = Mounting code IM B5 D = Mounting code IM B6 E = Mounting code IM B7 F = Mounting code IM B8 G = Mounting code IM B14 H = Mounting code IM B35 I = Mounting code IM V1 J = Mounting code IM V3 K = Mounting code IM V5 L = Mounting code IM V6 M = Mounting code IM V15 N = Mounting code IM V18 O = Mounting code IM V19 P = Mounting code IM V37		
Frame length				Efficiency class		
Z = S = Mechanical dimensions (short) M = Mechanical dimensions (medium) L = Mechanical dimensions (long)				1 = IE1 motor 2 = IE2 motor 3 = IE3 motor		



MATERIAL OF CONSTRUCTION

Component	Material
Stator frame	Cast iron
Front endshield	Cast iron
Rear endshield	Cast iron
Terminal box	Aluminum alloy / Cast iron
Terminal plate	Bakelite
Fan cover	Carbon steel
Fan	Reinforced polypropylene / Nylon
Electric rotor	Silicon steel / Carbon steel
Key	Carbon steel
Hardware	Carbon steel

Product Data

MOUNTING ARRANGEMENTS

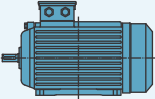
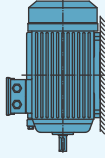
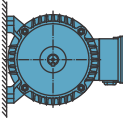
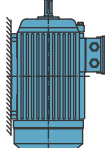
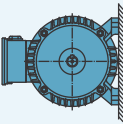
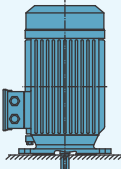
Mounting arrangements for rotating electrical machines are designated according to the IEC 60034-7 standard. Our motors are available with the mounting arrangements as per details below, depending on design and frame size.

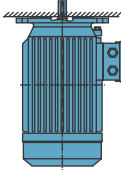
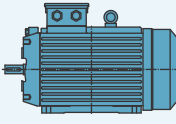
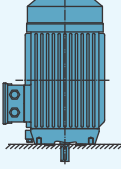
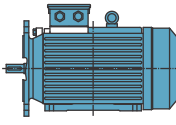
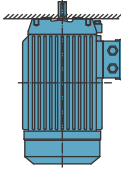
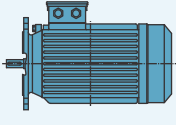
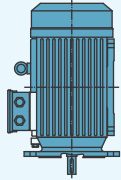
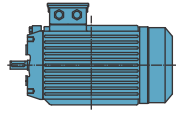
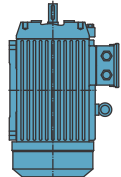





<i>Horizontal shaft mounting</i>					<i>Vertical shaft mounting</i>				
Mounting arrangement	Code I	Code II	Frame size	Mounting arrangement	Code I	Code II	Frame size		
 Mounted by foot, foot down	IM B3	IM 1001	63 - 355	 Mounted by foot, Driver end down	IM V5	IM 1011	63 - 160		
 Mounted by foot, foot left (viewed from Driver-end)	IM B6	IM 1051	63 - 160	 Mounted by foot, Driver end up	IM V6	IM 1031	63 - 160		
 Mounted by foot, foot right (viewed from Driver-end)	IM B7	IM 1061	63 - 160	 Mounted on Driver end side of flange type 'B', Driver end down	IM V1	IM 3011	63 - 355		
 Mounted by foot, foot up	IM B8	IM 1071	63 - 160	 Mounted on Driver end side of flange type 'B', Driver end up	IM V3	IM 3031	63 - 160		
 Mounted by foot, foot down, with additional mounting on D-end side of flange type 'C'	IM B34	IM 2101	63 - 132	 Mounted on Driver end side of flange type 'C', Driver end down	IM V18	IM 3611	63 - 132		
 Mounted by foot, foot down, with additional mounting on D-end side of flange type 'B'	IM B35	IM 2001	63 - 355	 Mounted on Driver end side of flange type 'C', Driver end up	IM V19	IM 3631	63 - 132		
 Mounted on Driver end side of flange type 'B'	IM B5	IM 3001	63 - 355	 Mounted by foot, with additional mounting on D-end side of flange, type 'B' D-end down	IM V15	IM 2011	63 - 160		
 Mounted on Driver end side of flange type 'C'	IM B14	IM 3601	63 - 160	 Mounted by foot, with additional mounting on D-end side of flange, type 'C' D-end up	IM V37	IM 2131	63 - 132		

Product Data

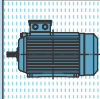
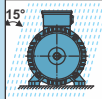
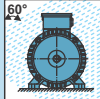
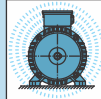
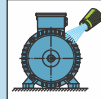
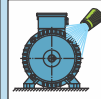
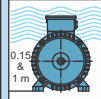
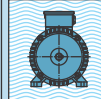
DEGREE OF PROTECTION (INGRESS PROTECTION - IP)

As per IEC 60034-5 standard, the Degree of protection of a rotating electrical machine is designated with the letters **IP** (Ingress Protection) followed by two characteristic numbers, with the following manner:

- First characteristic numeral: Describes to protection against access to hazardous parts and ingress of solids & foreign bodies.
- Second characteristic numeral: Describes to protection against ingress of water.
- All our motors shown in this catalog are IP 55.

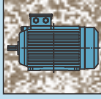
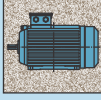
			Second numeral & description								
			0	1	2	3	4	5	6	7	8
First numeral & description			Not protected	Protection against vertically falling drops of water	Protection against direct spray of water up to 15° from vertical	Protection against direct spray of water up to 60° from vertical	Protection against water splashed from all directions	Protection against low pressure jet of water from any directions	Protection against strong jet of water from any directions	Protection against immersion between 0.15 & 1 m	Protection against long period of immersion under pressure
											
0	Not protected										
1	Protection against solid foreign bodies > 50 mm (e.g: Inadvertent contact with hand)										
2	Protection against solid foreign bodies > 12 mm (e.g: Inadvertent contact with the fingers)			IP 21	IP 22	IP 23					
3	Protection against solid foreign bodies > 2.5 mm (e.g: Inadvertent contact with wires and tools)										
4	Protection against solid foreign bodies > 1 mm (e.g: Inadvertent contact with wires, bands)						IP 44				
5	Protection against dust (no harmful deposits of dust)						IP 54	IP 55	IP 56		
6	Totally protected against deposition of dust										

Product Data

INSULATION CLASS

Motors are manufactured with class 'F' insulation as a standard and temperature rise limited to class 'B'. This allows for about 25°C reserve thermal capacity in the motor. The reserve thermal capacity is what helps maintain the integrity of the insulation and lengthen motor life.

Temperature rise and maximum temperatures at the hottest points of the winding according to the temperature class of IEC 60034-1.

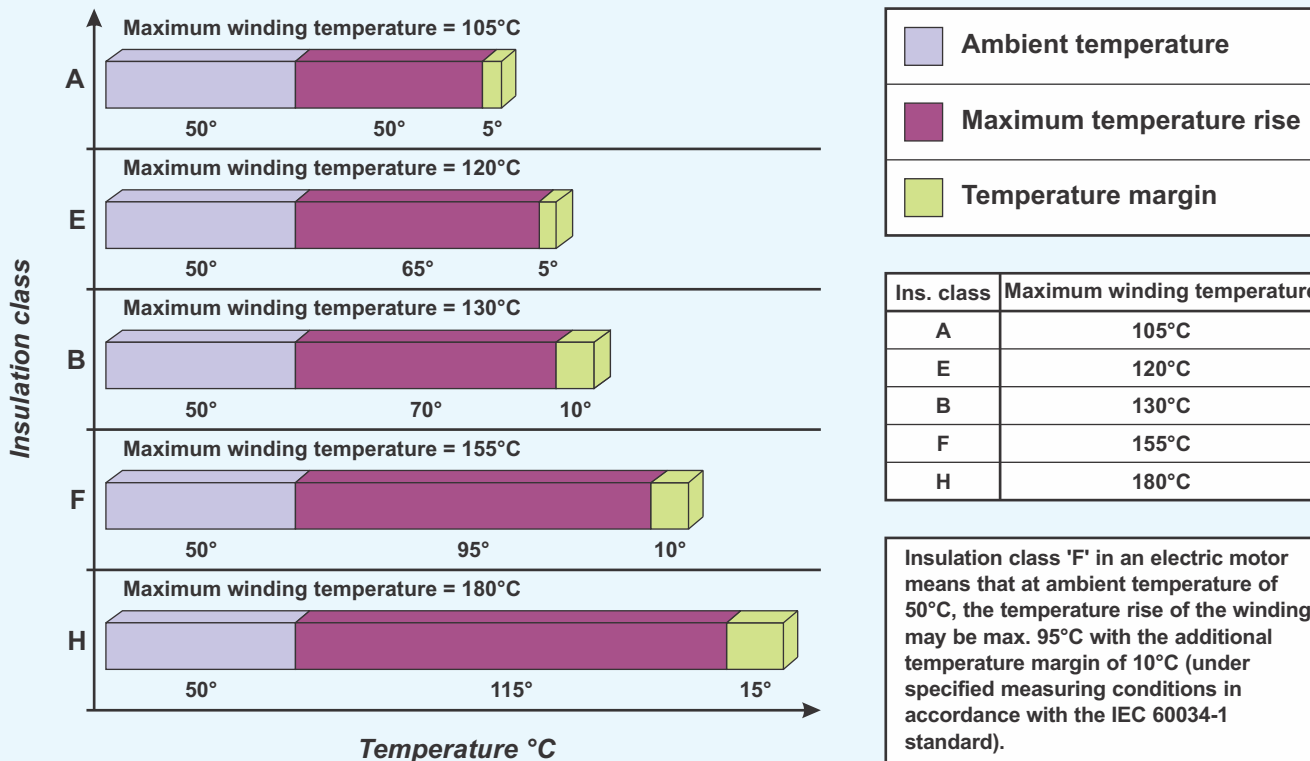

EFFECTS OF VARIATION OF VOLTAGE AND FREQUENCY

Effects of variation of voltage and frequency on the characteristics of motor

Characteristics	Voltage		Frequency	
	110%	90%	105%	95%
Torque Starting and maximum	Increase 21%	Decrease 19%	Decrease 10%	Increase 11%
Speed Synchronous Full load	No change Increase 1%	No change Decrease 1.5%	Increase 5% Increase 5%	Decrease 5% Decrease 5%
Current No load Starting Full load Temperature rise Overload capacity Magnetic noise	Increase 10-15% Increase 10-12% Decrease 7% Decrease 3-4% Increase 21% Slight Increase	Decrease 10-12% Decrease 10-12% Increase 11% Increase 6-7% Decrease 19% Slight Decrease	Decrease 5-6% Decrease 5-6% Slight Decrease Slight Decrease Slight Decrease Slight Decrease	Increase 5-6% Increase 5-6% Slight Increase Slight Increase Slight Increase Slight Increase
Efficiency Full load	Increase 0.5-1.0%	Decrease 2%	Slight Increase	Slight Decrease
Power factor	Decrease 3%	Increase 1%	Slight Increase	Slight Decrease

OVERLOAD

At operating temperature three-phase motors are capable of withstanding an overload for 15 second at 1.6 times the rated torque at rated voltage. This overload is according to the IEC 60034-1 standard and will not result in excessive heating.

Product Data

INSTALLATION CONDITIONS

The motors conform to degree of protection IP 55 as per IEC 60034-5.

The standard design for horizontal mounting is suitable for indoor and protected outdoor installation (temperature of coolant -20°C to +50°C).

For unprotected outdoor installation or severe climatic conditions (moisture category wet, climate group WORLDWIDE, extremely dusty site conditions, aggressive industrial atmosphere, danger of storm rain and coastal climate, danger of attack by termites, etc.), as well as vertical mounting, special protective measures are recommended, such as:

- Protective cowl (for vertical shaft-down motors)
- For vertical shaft-up motors additional bearing seal and flange drainage
- Special paint finish
- Treatment of winding with protective moisture-proof varnish
- Anti-condensation heating (possibly winding heating)
- Condensation drain holes.

The special measures to be applied have to be agreed with the factory once the conditions of installation have been settled.

The corresponding conditions of installation have to be clearly indicated in the order.

INSTALLATION AT ALTITUDES OF MORE THAN 1000 M ABOVE SEA LEVEL

Conditions	Altitude of installation		
	2000 m	3000 m	4000 m
At 50°C ambient temperature and thermal class 'B', Rated output reduce to approx	92%	84%	76%
At 50°C ambient temperature and thermal class 'F', Rated output reduce to approx	89%	79%	68%
Full nominal output to data tables with thermal class 'B' and ambient temperature of	32°C	24°C	16°C
Full nominal output to data tables with thermal class 'F' and ambient temperature of	30°C	19°C	9°C

NUMBERS OF STARTS/HOUR

The permissible nos. of starts per hour can be taken as given in the table below, provided the following conditions are met:

Additional moment of inertia \leq moment of inertia of the rotor: load torque rising with the square of the speed up to nominal torque; starts at even intervals.

Frame size	2 Pole	4 Pole	6 & 8 Pole
63 - 71	100	250	350
80 - 100	60	140	160
112 - 132	30	60	80
160 - 180	15	30	50
200 - 225	8	15	30
250 - 355	4	8	12



Product Data

BEARING DETAILS & LUBRICATION

Frame size	Nos. of poles	Drive end bearing	Non-Drive end bearing	Regreasing interval [hours]
63	2	6201 ZZ-C3	6201 ZZ-C3	-
	4, 6, 8			-
71	2	6202 ZZ-C3	6202 ZZ-C3	-
	4, 6, 8			-
80	2	6204 ZZ-C3	6204 ZZ-C3	-
	4, 6, 8			-
90	2	6205 ZZ-C3	6205 ZZ-C3	-
	4, 6, 8			-
100	2	6206 ZZ-C3	6206 ZZ-C3	-
	4, 6, 8			-
112	2	6206 ZZ-C3	6206 ZZ-C3	-
	4, 6, 8			-
132	2, 4	6208 ZZ-C3	6208 ZZ-C3	-
	6, 8	6308-C3	6308-C3	8000
160	2, 4, 8	6309-C3	6209-C3	4000
	6	6310-C3	6309-C3	8000
180	2	6310-C3	6210-C3	3500
	4, 6, 8			8000
200	2	6312-C3	6212-C3	3500
	4, 6, 8			8000
225	2	6313-C3	6313-C3	3500
	4, 6, 8			8000
250	2	6315-C3	6215-C3	3000
	4, 6, 8			7000
280	2	6317-C3	6316-C3	3000
	4, 6, 8	6317-C3	6316-C3	5000
315	2	6317-C3	6317-C3	2000
	4, 6, 8	6319-C3	6319-C3	4000
355	2	6319-C3	6319-C3	2000
	4, 6, 8	6322-C3	6319-C3	3000

TERMINAL BOX

Terminal box is provided on top as a standard.

CABLE SIZE

Frame size	Maximum cable size		Cable entry size	
	DOL starting	Star-Delta starting	IE1	IE2, IE3
63	3C x 2.5 mm ²	-	1 x 3/4"	1 x 3/4"
71	3C x 2.5 mm ²	-	1 x 3/4"	1 x 3/4"
80	3C x 4 mm ²	-	1 x 3/4"	1 x 3/4"
90	3C x 4 mm ²	-	2 x 3/4"	2 x 3/4"
100	3C x 10 mm ²	2 x 3C x 10 mm ²	2 x 3/4"	2 x 3/4"
112	3C x 10 mm ²	2 x 3C x 10 mm ²	2 x 3/4"	2 x 3/4"
132	3C x 10 mm ²	2 x 3C x 10 mm ²	2 x 1"	2 x 1"
160	3C x 35 mm ²	2 x 3C x 25 mm ²	2 x 1"	2 x 1"
180	3C x 35 mm ²	2 x 3C x 25 mm ²	2 x M40 x 1.5	2 x M40 x 1.5
200	3C x 120 mm ²	2 x 3C x 70 mm ²	2 x M50 x 1.5	2 x M50 x 1.5
225	3C x 120 mm ²	2 x 3C x 70 mm ²	2 x M50 x 1.5	2 x M50 x 1.5
250	3C x 120 mm ²	2 x 3C x 70 mm ²	2 x M63 x 1.5	2 x M63 x 1.5
280	3C x 240 mm ²	2 x 3C x 150 mm ²	2 x M63 x 1.5	2 x M63 x 1.5
315	3C x 240 mm ²	2 x 3C x 150 mm ²	2 x M63 x 1.5	2 x M63 x 1.5
355	3C x 400 mm ²	2 x 3C x 300 mm ²	2 x M63 x 1.5	2 x M63 x 1.5



Product Data

NOISE LEVEL

As per IEC 60034-9 standard the permitted noise levels of electric machines are mentioned as per details below.

P _N		IE1 NOISE LEVEL						IE2, IE3 NOISE LEVEL					
		2-Pole (3000 r/min)		4-Pole (1500 r/min)		6-Pole (1000 r/min)		2-Pole (3000 r/min)		4-Pole (1500 r/min)		6-Pole (1000 r/min)	
kW	HP	Measuring surface sound at 50 Hz Lpfa dB(A)	Sound pressure level at 50 Hz LWA dB(A)	Measuring surface sound at 50 Hz Lpfa dB(A)	Sound pressure level at 50 Hz LWA dB(A)	Measuring surface sound at 50 Hz Lpfa dB(A)	Sound pressure level at 50 Hz LWA dB(A)	Measuring surface sound at 50 Hz Lpfa dB(A)	Sound pressure level at 50 Hz LWA dB(A)	Measuring surface sound at 50 Hz Lpfa dB(A)	Sound pressure level at 50 Hz LWA dB(A)	Measuring surface sound at 50 Hz Lpfa dB(A)	Sound pressure level at 50 Hz LWA dB(A)
0.75	1	56	67	47	58	45	57	56	67	46	57	45	57
1.1	1.5	56	67	49	61	45	57	57	68	48	60	45	57
1.5	2	61	73	49	61	49	61	61	73	48	60	49	61
2.2	3	62	74	52	64	53	65	61	73	52	64	53	65
3	4	64	76	52	64	57	69	63	75	52	64	53	65
3.7	5	65	77	53	65	57	69	65	75	53	65	55	67
5.5	7.5	68	80	59	71	57	69	68	80	59	71	55	67
7.5	10	68	80	59	71	61	73	68	80	59	71	57	69
11	15	73	86	62	72	61	73	72	84	62	72	57	69
15	20	73	86	63	73	61	73	73	86	62	73	58	70
18.5	25	73	86	64	76	64	76	73	86	64	76	58	70
22	30	75	88	64	76	64	76	74	87	64	76	61	73
30	40	78	92	66	79	64	76	77	91	64	76	62	74
37	50	78	92	68	81	66	78	77	91	64	76	62	74
45	60	78	92	68	81	68	80	77	91	65	78	63	75
55	75	79	93	70	83	68	80	80	94	66	79	64	76
75	100	80	94	72	85	73	85	80	94	69	82	68	80
90	120	80	94	73	86	73	85	80	94	69	82	68	80
110	150	82	96	80	93	73	85	81	95	77	90	73	83
132	180	82	96	80	93	73	85	81	95	77	90	73	83
160	215	85	99	84	97	80	92	85	99	82	95	78	90
200	270	86	100	84	97	80	92	85	99	82	95	78	90
250	340	88	102	88	101	80	92	88	102	84	97	78	90
315	430	89	103	88	101	-	-	88	102	84	97	-	-

VIBRATION LEVEL

The amplitude of vibration in electric motors are governed by IEC 60034-14, Mechanical vibration of rotating electrical machines with frame size 56 & large - methods of measurement and limits.

- Rotors are dynamically balanced with half key and the standard version meets the vibration levels of Grade A (without special vibration requirements) described in IEC 60034-14. As an option, motors can be supplied in conformance with vibration of Grade B.
- The RMS speed and vibration levels in mm/s of Grade A and B are shown in below table.

Vibration	Assembly	Vibration speed RMS (mm/s)		
		Shaft height 63 ≤ H ≤ 132	Shaft height 132 < H ≤ 280	Shaft height H > 280
Grade A	Free suspension	1.6	2.2	2.8
Grade B	Free suspension	0.7	1.1	1.8

If the machine vibrates even after proper alignment on an amply size foundation, this could be caused by incorrect balanced pulley, coupling or similar, fitted to the shaft. Other causes could be weak foundation.

Product Data

EXPLODED VIEW AND SPARE PARTS DESCRIPTION

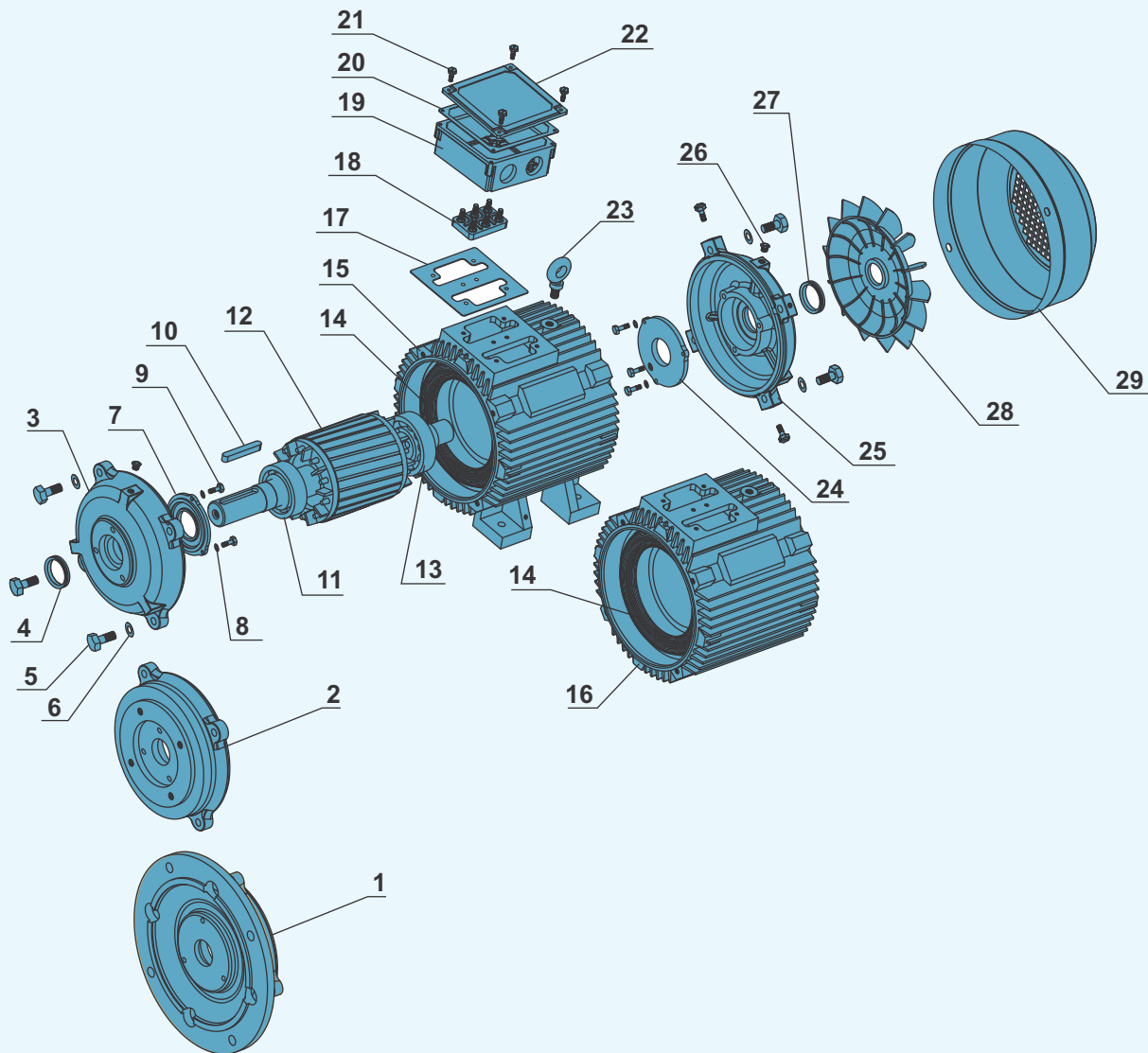

Pos.	Parts name	Pos.	Parts name
1	B5 flange	16	B4/B14 stator frame
2	B14 flange	17	Gasket
3	Front end shield	18	Terminal plate
4	V-seal	19	Terminal box base
5	Hex bolt	20	Gasket
6	Spring washer	21	Screw
7	Front bearing cover	22	Terminal box cover
8	Spring washer	23	Lifting bolt
9	Hex bolt	24	Rear bearing cover
10	Key	25	Rear end shield
11	Ball bearing (Drive end)	26	Grease nipple
12	Electric rotor	27	V-seal
13	Ball bearing (Non-drive end)	28	Fan
14	Stator stack	29	Fan cover
15	B3 stator frame		



Product Data

MOTOR PERFORMANCE DATA - 3000 RPM (2 POLE)

IE 1

STANDARD EFFICIENCY

Rated output P _N		Frame size	Rated speed n [min ⁻¹]	Efficiency η [%]	Power factor [cos φ]	Rated current I _N at 415 V [A]	Rated Torque T _N [Nm]	DOL starting		Break down Torque / Rated Torque T _B /T _N	Moment of inertia J [kgm ²]	Gross weight [kg]
kW	HP							Locked rotor current / Rated current I _L /I _N	Locked rotor Torque / Rated Torque T _L /T _N			
0.37	0.5	71	2773	66.1	0.84	0.86	1.30	4.72	3.33	3.50	0.0019	10
0.55	0.75	71	2798	69.1	0.97	1.07	1.90	5.25	2.29	2.40	0.0019	15
0.75	1	80	2833	72.1	0.89	1.52	2.58	5.70	3.40	3.55	0.0038	16
1.1	1.5	80	2875	75.0	0.88	2.21	3.77	5.50	2.34	2.50	0.0048	22
1.5	2	90S	2818	77.2	0.95	2.75	5.12	6.00	2.30	2.50	0.0125	24
2.2	3	90L	2800	79.7	0.90	4.15	7.00	5.50	2.88	2.95	0.0229	28
3.7	5	100L	2890	82.7	0.97	6.28	12.53	6.00	2.73	2.85	0.0257	46
5.5	7.5	132S	2881	84.7	0.94	9.47	18.56	6.00	3.62	3.78	0.0853	80
7.5	10	132M	2885	86.0	0.94	12.76	25.22	6.00	2.05	2.20	0.1024	88
11	15	160M	2912	87.6	0.93	18.49	36.77	5.90	1.89	2.00	0.2029	128
15	20	160M	2943	88.7	0.98	23.79	50.11	6.00	2.35	2.50	0.2435	144
18.5	25	160L	2943	89.3	0.97	29.48	61.59	6.00	1.92	2.10	0.4179	182
22	30	180M	2959	89.9	0.97	34.67	73.26	6.00	2.12	2.25	0.5032	273
30	40	200L	2950	90.7	0.94	48.52	97.13	7.62	2.40	2.20	0.9500	327
37	50	200L	2915	91.2	0.91	61.15	119.64	6.10	2.00	2.30	0.9950	345
45	60	225M	2965	91.7	0.90	74.96	145.14	6.40	2.25	2.40	1.0400	365
55	75	250M	2975	92.1	0.93	88.18	176.52	6.40	2.20	2.40	1.0500	480
75	100	280S	2975	92.7	0.90	123.33	240.75	6.50	2.20	2.50	2.5414	610
90	120	280M	2975	93.0	0.90	147.69	289.00	6.50	2.20	2.50	2.9368	680

Product Data

MOTOR PERFORMANCE DATA - 1500 RPM (4 POLE)

IE 1

STANDARD EFFICIENCY

Rated output P _N		Frame size	Rated speed n [min ⁻¹]	Efficiency η [%]	Power factor [cos φ]	Rated current I _N at 415 V [A]	Rated Torque T _N [Nm]	DOL starting		Break down Torque / Rated Torque T _B /T _N	Moment of inertia J [kgm ²]	Gross weight [kg]
kW	HP							Locked rotor current / Rated current I _L /I _N	Locked rotor Torque / Rated Torque T _L /T _N			
0.37	0.5	71	1415	65.1	0.73	0.99	2.66	4.15	2.54	2.65	0.0030	10
0.55	0.75	80	1417	69.1	0.66	1.57	3.92	3.50	2.38	2.50	0.0086	15
0.75	1	80	1440	72.1	0.70	1.93	5.27	3.70	2.36	2.50	0.0093	16
1.1	1.5	90S	1432	75.0	0.81	2.44	7.67	4.80	2.29	2.50	0.0152	19
1.5	2	90L	1412	77.2	0.86	3.04	10.39	4.30	2.00	2.25	0.0120	22
2.2	3	100L	1445	79.7	0.91	4.12	15.12	6.00	2.15	2.25	0.0272	47
3.7	5	112M	1445	82.7	0.83	7.30	25.07	5.60	1.92	2.10	0.0596	55
5.5	7.5	132S	1460	84.7	0.83	10.72	37.00	6.00	1.92	2.10	0.0850	85
7.5	10	132M	1460	86.0	0.84	14.28	50.09	6.00	1.80	2.00	0.1181	101
11	15	160M	1456	87.6	0.84	20.59	72.96	5.10	1.72	1.85	0.4569	139
15	20	160L	1456	88.7	0.83	27.94	99.50	5.00	2.29	2.35	0.6005	166
18.5	25	180M	1462	89.3	0.91	30.81	122.71	5.00	2.66	2.75	0.7355	273
22	30	180L	1452	89.9	0.93	35.85	145.93	6.00	2.00	2.20	0.9244	283
30	40	200L	1474	90.7	0.90	50.30	199.00	5.70	2.02	2.20	2.5653	342
37	50	225S	1470	91.2	0.88	62.90	239.61	5.90	1.90	2.20	2.6600	351
45	60	225M	1470	91.7	0.84	79.97	292.49	6.50	2.80	2.95	2.7800	375
55	75	250M	1470	92.1	0.85	95.97	356.17	6.00	1.40	1.60	3.0500	503
75	100	280S	1480	92.7	0.90	123.07	484.45	6.00	2.20	2.50	5.0000	625
90	120	280M	1480	93.0	0.90	146.44	580.55	6.00	2.20	2.50	6.0000	721



Product Data

MOTOR PERFORMANCE DATA - 1000 RPM (6 POLE)

IE 1

STANDARD EFFICIENCY

Rated output P _N		Frame size	Rated speed n [min ⁻¹]	Efficiency η [%]	Power factor [cos φ]	Rated current I _N at 415 V [A]	Rated Torque T _N [Nm]	DOL starting		Break down Torque / Rated Torque T _B /T _N	Moment of inertia J [kgm ²]	Gross weight [kg]
								Locked rotor current / Rated current I _L /I _N	Locked rotor Torque / Rated Torque T _L /T _N			
kW	HP											
0.37	0.5	80	914	63.0	0.66	1.15	4.11	3.52	2.10	2.25	0.0027	16
0.55	0.75	80	918	67.0	0.65	1.71	6.11	3.20	2.18	2.30	0.0084	18
0.75	1	90S	923	70.0	0.79	1.83	8.05	3.50	1.90	2.00	0.0122	21
1.1	1.5	90L	925	72.9	0.71	3.01	11.67	3.50	2.10	2.35	0.0235	23
1.5	2	100L	945	75.2	0.78	3.43	15.92	4.34	2.09	2.30	0.0290	49
2.2	3	112M	959	77.7	0.72	5.27	23.09	5.11	1.93	2.15	0.1069	55
3.7	5	132S	910	80.9	0.85	7.12	38.83	5.24	1.60	1.70	0.2050	88
5.5	7.5	132M	954	83.1	0.82	10.91	57.10	6.06	1.60	1.68	0.2432	108
7.5	10	160M	970	84.7	0.79	15.09	77.03	5.81	1.88	1.95	0.2916	136
11	15	160L	974	86.4	0.87	19.88	112.37	6.39	2.10	2.30	0.7765	156
15	20	180L	973	87.7	0.84	27.60	154.06	5.25	1.77	1.90	1.2960	280
18.5	25	200L	974	88.6	0.88	32.14	190.00	4.92	1.85	1.95	1.4435	334
22	30	200L	980	79.2	0.87	38.24	225.96	4.90	1.45	1.55	1.9654	345
30	40	225M	945	90.2	0.84	53.71	308.12	5.00	1.96	2.10	2.8560	365
37	50	250M	982	90.8	0.84	65.89	359.90	5.50	1.30	1.50	3.2200	485
45	60	280S	980	91.4	0.87	77.13	438.36	6.00	2.30	2.30	5.1100	605
55	75	280M	980	91.9	0.85	96.28	536.42	6.00	2.30	2.30	6.1600	655
75	100	315S	985	92.6	0.86	129.35	727.20	7.00	2.10	2.20	4.1100	1030
90	120	315M	985	92.9	0.86	154.72	872.60	6.70	2.00	2.10	4.7800	1110



Product Data

MOTOR PERFORMANCE DATA - 750 RPM (8 POLE)

IE 1

STANDARD EFFICIENCY

Rated output P _N		Frame size	Rated speed n [min ⁻¹]	Efficiency η [%]	Power factor [cos φ]	Rated current I _N at 415 V [A]	Rated Torque T _N [Nm]	DOL starting		Break down Torque / Rated Torque T _B /T _N	Moment of inertia J [kgm ²]	Gross weight [kg]
kW	HP							Locked rotor current / Rated current I _L /I _N	Locked rotor Torque / Rated Torque T _L /T _N			
0.37	0.5	90S	710	67.5	0.59	1.29	5.12	3.50	2.33	2.50	0.0160	21
0.55	0.75	90L	712	70.7	0.59	1.83	7.73	3.55	2.66	2.80	0.0210	24
0.75	1	100L	720	71.0	0.56	2.62	9.95	3.87	2.32	2.50	0.0300	47
1.1	1.5	100L	719	76.6	0.68	2.94	14.59	4.50	2.00	2.20	0.0340	50
1.5	2	112M	711	77.0	0.69	3.93	19.90	4.00	1.67	1.80	0.0570	55
2.2	3	132S	706	78.0	0.70	5.61	29.18	4.18	1.66	1.85	0.1740	86
3.7	5	160M	731	82.0	0.73	8.60	48.75	5.35	1.65	1.75	0.2140	131
5.5	7.5	160M	726	85.5	0.74	12.09	72.46	5.20	1.70	1.85	0.4500	141
7.5	10	160L	728	85.0	0.75	16.37	98.14	5.10	1.34	1.50	0.6300	163
11	15	180L	725	88.0	0.72	24.15	144.94	5.00	2.00	2.20	0.5949	290
15	20	200L	735	88.8	0.83	28.31	203.19	6.20	2.67	3.15	1.7600	343
18.5	25	225S	732	89.0	0.83	34.84	241.44	3.60	1.40	1.60	2.9580	355
22	30	225M	730	90.7	0.78	43.26	287.81	6.60	1.90	2.00	0.5470	370
30	40	250M	735	91.0	0.79	58.06	382.47	6.60	1.90	2.00	0.8340	483
37	50	280S	735	91.5	0.79	71.21	484.04	6.60	1.90	2.00	1.9300	587
45	60	280M	735	92.0	0.79	86.14	580.74	6.60	1.80	2.00	3.6500	653
55	75	315S	735	93.0	0.81	101.57	709.80	6.60	1.80	2.00	4.7900	1030
75	100	315M	735	93.2	0.81	138.21	967.91	6.60	1.80	2.00	5.5800	1130
90	120	315L	735	94.0	0.82	162.44	161.49	6.60	1.80	2.00	6.3700	1185

Product Data

MOTOR PERFORMANCE DATA - 3000 RPM (2 POLE)

IE 2

HIGH EFFICIENCY

Rated output P _N		Frame size	Rated speed n [min ⁻¹]	Efficiency η [%]	Power factor [cos φ]	Rated current I _N at 415 V [A]	Rated Torque T _N [Nm]	DOL starting		Break down Torque / Rated Torque T _B /T _N	Moment of inertia J [kgm ²]	Gross weight [kg]
kW	HP							Locked rotor current / Rated current I _L /I _N	Locked rotor Torque / Rated Torque T _L /T _N			
0.75	1	80	2875	77.4	0.83	1.62	2.49	5.30	2.5	3.0	0.0008	20
1.1	1.5	80	2875	79.6	0.84	2.20	3.65	7.00	3.2	3.8	0.0009	21
1.5	2	90S	2890	81.3	0.84	2.95	4.96	7.10	2.7	3.5	0.0012	26
2.2	3	90L	2890	83.2	0.85	4.21	7.27	6.90	2.4	3.0	0.0015	29
3.7	5	100L	2914	85.5	0.88	6.69	13.11	7.50	2.5	3.0	0.0050	62
5.5	7.5	132S	2937	87.0	0.86	10.04	17.88	7.50	2.7	3.5	0.0100	93
7.5	10	132S	2940	88.1	0.88	13.25	24.36	7.50	2.4	3.3	0.0120	101
11	15	160M	2930	89.4	0.89	19.00	35.85	7.60	2.2	2.9	0.0385	149
15	20	160M	2930	90.3	0.89	25.68	48.89	7.60	2.3	3.0	0.0466	161
18.5	25	160L	2937	90.9	0.89	31.50	60.15	7.40	2.3	3.1	0.0550	177
22	30	180M	2940	91.3	0.88	37.72	71.46	7.80	2.8	3.2	0.0810	248
30	40	200L	2950	92.0	0.88	51.00	97.12	7.80	2.6	3.0	0.1250	308
37	50	200L	2950	92.5	0.89	61.99	119.78	7.70	2.6	3.0	0.1450	328
45	60	225M	2960	92.9	0.89	75.07	145.19	7.50	2.4	2.6	0.2280	421
55	75	250M	2965	93.2	0.90	90.44	177.15	7.10	2.3	2.8	0.3050	515
75	100	280S	2970	93.8	0.90	122.55	241.16	7.40	2.5	2.8	0.6000	655
90	120	280M	2970	94.1	0.91	144.83	289.39	7.60	2.8	2.8	0.6860	703
110	150	315S	2975	94.3	0.91	176.65	353.11	6.90	2.4	2.8	1.1700	1078
132	180	315M	2975	94.6	0.91	211.53	423.73	7.10	2.6	2.9	1.8000	1139
160	215	315L	2975	94.8	0.92	253.08	513.61	7.10	2.5	2.9	2.1200	1241
200	270	315L	2975	95.0	0.92	316.03	642.02	6.90	2.5	2.8	2.5000	1272
250	340	355M	2980	95.0	0.92	393.80	801.17	7.00	2.5	2.8	3.1000	2088
315	430	355L	2980	95.0	0.92	495.15	1009.48	7.00	2.5	2.9	3.6000	2496



Product Data

MOTOR PERFORMANCE DATA - 1500 RPM (4 POLE)

IE 2

HIGH EFFICIENCY

Rated output P _N		Frame size	Rated speed n [min ⁻¹]	Efficiency η [%]	Power factor [cos φ]	Rated current I _N at 415 V [A]	Rated Torque T _N [Nm]	DOL starting		Break down Torque / Rated Torque T _B /T _N	Moment of inertia J [kgm ²]	Gross weight [kg]
kW	HP							Locked rotor current / Rated current I _L /I _N	Locked rotor Torque / Rated Torque T _L /T _N			
0.75	1	80	1400	79.6	0.76	1.66	5.12	5.0	2.4	2.9	0.0022	22
1.1	1.5	90S	1440	81.4	0.77	2.37	7.3	6.0	3.0	3.5	0.0024	27
1.5	2	90L	1445	82.8	0.77	3.19	9.91	6.8	3.2	3.8	0.0030	32
2.2	3	100L	1440	84.3	0.81	4.37	14.6	7.0	3.0	3.5	0.0056	56
3.7	5	112M	1445	86.3	0.82	7.09	26.4	7.5	3.5	4.0	0.0097	67
5.5	7.5	132S	1455	87.7	0.83	10.32	36.1	6.4	2.2	2.8	0.0220	98
7.5	10	132M	1455	88.7	0.84	13.77	49.2	7.0	2.4	3.0	0.0300	108
11	15	160M	1460	89.8	0.84	19.95	71.9	6.9	2.5	2.9	0.0740	162
15	20	160L	1460	90.6	0.85	26.69	98.1	7.5	2.5	3.0	0.0920	173
18.5	25	180M	1470	91.2	0.86	32.42	120.2	7.8	2.6	3.1	0.1350	247
22	30	180L	1470	91.6	0.86	38.43	142.9	7.5	2.6	3.1	0.1600	286
30	40	200L	1470	92.3	0.86	52.07	194.9	7.1	2.4	2.9	0.2650	337
37	50	225S	1480	92.7	0.87	63.21	238.8	7.5	2.5	2.7	0.4200	383
45	60	225M	1480	93.1	0.87	76.55	290.4	7.6	2.5	2.8	0.4700	413
55	75	250M	1480	93.5	0.87	93.36	354.9	7.3	2.6	2.7	0.6600	528
75	100	280S	1480	94.0	0.87	126.64	484	7.6	2.7	2.7	1.1400	645
90	120	280M	1480	94.2	0.87	151.49	580.7	7.5	2.7	2.7	1.4200	745
110	150	315S	1485	94.5	0.88	182.67	707.4	7.1	2.7	2.9	3.4000	1080
132	180	315M	1485	94.7	0.88	218.51	848.9	7.3	2.7	2.9	3.5800	1167
160	215	315L	1485	94.9	0.89	261.34	1029	7.4	3.0	3.0	4.1000	1237
200	270	315L	1485	95.1	0.89	326.34	1286	7.6	3.0	3.0	4.9000	1355
250	340	355M	1490	95.1	0.90	401.71	1602	7.5	2.8	2.9	6.7000	1884
315	430	355L	1490	95.1	0.90	505.11	2019	7.4	2.6	2.8	8.4000	2090

Product Data

MOTOR PERFORMANCE DATA - 1000 RPM (6 POLE)

IE 2

HIGH EFFICIENCY

Rated output P_N		Frame size	Rated speed n [min ⁻¹]	Efficiency η [%]	Power factor [cos ϕ]	Rated current I_N at 415 V [A]	Rated Torque T_N [Nm]	DOL starting		Break down Torque / Rated Torque T_B/T_N	Moment of inertia J [kgm ²]	Gross weight [kg]
kW	HP							Locked rotor current / Rated current I_L/I_N	Locked rotor Torque / Rated Torque T_L/T_N			
0.75	1	90S	934	75.9	0.72	1.91	7.67	4.5	2.2	2.4	0.0030	27
1.1	1.5	90L	945	78.1	0.72	2.72	11.1	4.5	2.4	2.6	0.0040	29
1.5	2	100L	945	79.8	0.75	3.49	15.2	4.2	1.8	2.2	0.0082	54
2.2	3	112M	960	81.8	0.76	4.90	21.9	4.5	2.3	2.8	0.0140	64
3.7	5	132M	965	84.3	0.76	7.96	39.6	5.0	2.3	2.7	0.0360	103
5.5	7.5	132M	965	86.0	0.77	11.45	54.4	5.5	1.9	2.8	0.0400	115
7.5	10	160M	970	87.2	0.78	15.17	73.8	6.5	2.0	3.0	0.0880	175
11	15	160L	970	88.7	0.78	21.87	108.3	7.5	2.4	3.3	0.1150	192
15	20	180L	975	89.7	0.81	28.47	146.9	6.4	2.0	2.7	0.2100	260
18.5	25	200L	980	90.4	0.81	34.80	180.3	7.0	2.3	3.0	0.3100	303
22	30	200L	980	90.9	0.83	40.17	214.4	7.0	2.3	2.8	0.3500	318
30	40	225M	980	91.7	0.84	53.66	292.3	6.5	2.2	2.7	0.5340	390
37	50	250M	980	92.2	0.86	64.36	360.6	6.9	2.5	2.7	0.8250	512
45	60	280S	980	92.7	0.86	77.86	438.5	7.0	2.2	2.4	1.3500	628
55	75	280M	980	93.1	0.86	94.85	536	7.1	2.4	2.5	1.6000	677
75	100	315S	985	93.7	0.86	128.66	727.2	7.3	2.8	3.0	4.0000	1063
90	120	315M	985	94.0	0.86	153.74	872.6	7.1	2.7	2.9	4.6000	1143
110	150	315L	985	94.3	0.86	187.71	1066	7.4	2.9	2.9	5.2500	1216
132	180	315L	985	94.6	0.87	221.72	1280	7.6	3.0	3.1	6.2000	1338
160	215	355M	990	94.8	0.88	265.42	1543	7.6	3.1	3.1	9.6000	1731
200	270	355M	990	95.0	0.88	331.08	1929	7.8	3.0	3.0	10.800	1782
250	340	355L	990	95.0	0.88	413.42	2412	7.7	3.1	3.0	12.500	1884



Product Data

MOTOR PERFORMANCE DATA - 3000 RPM (2 POLE)

IE 3

PREMIUM EFFICIENCY

Rated output P _N		Frame size	Rated speed n [min ⁻¹]	Efficiency η [%]	Power factor [cos φ]	Rated current I _N at 415 V [A]	Rated Torque T _N [Nm]	DOL starting		Break down Torque / Rated Torque T _B /T _N	Moment of inertia J [kgm ²]	Gross weight [kg]
kW	HP							Locked rotor current / Rated current I _L /I _N	Locked rotor Torque / Rated Torque T _L /T _N			
0.75	1	80	2830	80.7	0.82	1.58	2.5	6.5	3.3	3.5	0.009	22
1.1	1.5	80	2830	82.7	0.82	2.26	3.7	6.5	3.3	3.5	0.011	23
1.5	2	90S	2885	84.2	0.87	2.85	5.0	6.5	3.0	3.3	0.013	29
2.2	3	90L	2885	85.9	0.87	4.10	7.3	6.5	3.0	3.3	0.016	32
3.7	5	100L	2885	87.8	0.87	6.74	12.3	6.5	3.0	3.3	0.021	68
5.5	7.5	132S	2935	89.2	0.89	9.64	17.9	6.5	2.3	2.5	0.134	102
7.5	10	132S	2935	90.1	0.89	13.0	24.4	6.5	2.3	2.5	0.15	111
11	15	160M	2935	91.2	0.89	18.9	35.8	6.5	2.4	2.7	0.22	164
15	20	160M	2935	91.9	0.89	25.5	48.8	6.5	2.4	2.7	0.3	177
18.5	25	160L	2935	92.4	0.89	31.3	60.2	6.5	2.4	2.7	0.374	195
22	30	180M	2955	92.7	0.88	37.5	71.1	7.0	2.5	2.7	0.5	260
30	40	200L	2965	93.3	0.88	50.8	96.5	7.0	2.5	2.7	0.91	323
37	50	200L	2965	93.7	0.88	62.4	119.6	7.0	2.5	2.7	1.13	344
45	60	225M	2965	94.0	0.9	74.0	145.0	7.0	2.5	2.7	2.11	442
55	75	250M	2965	94.3	0.91	89.2	177.4	7.0	2.5	2.7	2.60	541
75	100	280S	2970	94.7	0.91	121	241.1	7.0	2.0	2.7	3.08	688
90	120	280M	2970	95.0	0.91	145	289.1	7.0	2.0	2.7	3.69	738
110	150	315S	2985	95.2	0.88	183	351.8	7.0	2.4	2.7	5.0	1132
132	180	315M	2985	95.4	0.88	219	422.4	7.0	2.4	2.7	6.2	1196
160	215	315L	2985	95.6	0.88	265	511.6	7.0	2.4	2.7	7.7	1303



Product Data

MOTOR PERFORMANCE DATA - 1500 RPM (4 POLE)

IE 3

PREMIUM EFFICIENCY

Rated output P _N		Frame size	Rated speed n [min ⁻¹]	Efficiency η [%]	Power factor [cos φ]	Rated current I _N at 415 V [A]	Rated Torque T _N [Nm]	DOL starting		Break down Torque / Rated Torque T _B /T _N	Moment of inertia J [kgm ²]	Gross weight [kg]
kW	HP							Locked rotor current / Rated current I _L /I _N	Locked rotor Torque / Rated Torque T _L /T _N			
0.75	1	80	1430	82.5	0.77	1.64	5.00	6.0	2.5	2.8	0.015	24
1.1	1.5	90S	1435	84.1	0.8	2.27	7.35	6.0	2.5	2.8	0.017	30
1.5	2	90L	1435	85.3	0.8	3.06	10.00	6.0	2.5	2.8	0.023	35
2.2	3	100L	1435	86.7	0.81	4.36	14.60	6.0	2.6	3.0	0.028	62
3.7	5	112M	1455	88.4	0.8	7.28	24.30	6.5	2.7	3.0	0.066	74
5.5	7.5	132S	1470	89.6	0.82	10.4	35.67	6.5	2.6	2.8	0.141	108
7.5	10	132M	1470	90.4	0.83	13.9	48.71	6.5	2.6	2.8	0.193	119
11	15	160M	1470	91.4	0.84	19.9	71.44	6.5	2.7	3.0	0.375	178
15	20	160L	1470	92.1	0.84	27.0	97.41	6.5	2.7	3.0	0.52	190
18.5	25	180M	1470	92.6	0.84	33.1	120.1	7.0	2.6	2.8	0.75	259
22	30	180L	1470	93.0	0.85	38.7	143.1	7.0	2.6	2.8	0.86	300
30	40	200L	1475	93.6	0.87	51.3	194.0	7.0	2.6	2.6	1.38	354
37	50	225S	1482	93.9	0.84	65.3	238.1	7.0	2.6	2.6	2.30	402
45	60	225M	1482	94.2	0.84	79.1	290.1	7.0	2.6	2.6	2.83	434
55	75	250M	1482	94.6	0.84	96.3	353.8	7.0	2.6	2.6	3.06	554
75	100	280S	1482	95.0	0.86	128	483.1	6.5	2.5	2.5	5.53	677
90	120	280M	1482	95.2	0.86	153	579.2	6.5	2.5	2.5	6.36	782
110	150	315S	1488	95.4	0.85	189	705.6	6.8	2.5	3.0	11.70	1134
132	180	315M	1488	95.6	0.85	226	846.7	6.8	2.5	3.0	14.0	1225
160	215	315L	1488	95.8	0.85	273	1029.0	6.5	2.5	3.0	16.9	1299
200	270	315L	1490	96.0	0.88	329	1283.8	6.5	2.0	2.4	23.3	1423
250	340	355L	1490	96.0	0.88	412	1597.4	6.5	2.0	2.4	32.7	1978
315	430	355L	1490	96.0	0.88	519	2018.8	6.5	2.0	2.4	37.9	2194



Product Data

MOTOR PERFORMANCE DATA - 1000 RPM (6 POLE)

IE 3

PREMIUM EFFICIENCY

Rated output P _N		Frame size	Rated speed n [min ⁻¹]	Efficiency η [%]	Power factor [cos φ]	Rated current I _N at 415 V [A]	Rated Torque T _N [Nm]	DOL starting		Break down Torque / Rated Torque T _B /T _N	Moment of inertia J [kgm ²]	Gross weight [kg]
kW	HP							Locked rotor current / Rated current I _L /I _N	Locked rotor Torque / Rated Torque T _L /T _N			
0.75	1	90S	945	78.9	0.72	1.84	7.55	4.0	2.2	2.5	0.017	30
1.1	1.5	90L	945	81.0	0.72	2.62	11.07	4.0	2.2	2.5	0.025	32
1.5	2	100L	945	82.5	0.72	3.51	15.19	4.5	2.0	2.5	0.029	59
2.2	3	112M	960	84.3	0.77	4.72	21.85	5.0	2.0	2.5	0.074	70
3.7	5	132M	960	86.5	0.78	7.63	36.75	5.5	2.0	2.5	0.202	113
5.5	7.5	132M	960	88.0	0.78	11.1	54.68	5.5	2.0	2.5	0.276	127
7.5	10	160M	965	89.1	0.8	14.6	74.19	5.5	2.5	2.5	0.45	193
11	15	160L	965	90.3	0.8	21.2	108.8	5.5	2.5	2.5	0.65	211
15	20	180L	970	91.2	0.82	27.9	148.0	5.5	2.5	2.5	1.20	273
18.5	25	200L	975	91.7	0.86	32.6	181.3	6.5	2.6	2.3	1.81	318
22	30	200L	975	92.2	0.88	37.7	215.6	6.5	2.6	2.3	2.10	334
30	40	225M	978	92.9	0.88	51.1	293.0	6.5	2.5	2.3	3.51	410
37	50	250M	978	93.3	0.88	62.7	360.6	6.5	2.5	2.3	3.72	538
45	60	280S	984	93.7	0.84	79.5	436.1	6.5	2.5	2.4	5.11	659
55	75	280M	984	94.1	0.86	94.6	533.1	6.0	2.4	2.4	6.16	711
75	100	315S	989	94.6	0.84	131	724.2	6.0	2.3	2.5	12.4	1116
90	120	315M	989	94.9	0.84	157	868.3	6.0	2.3	2.5	15.5	1200
110	150	315L	990	95.1	0.84	192	1058.4	6.0	2.3	2.5	18.0	1277
132	180	315L	990	95.4	0.86	224	1274.0	6.0	2.3	2.5	21.5	1405
160	215	355L	990	95.6	0.84	277	1538.6	6.0	2.0	2.5	28.7	1818
200	270	355L	991	95.8	0.84	346	1930.6	6.0	2.0	2.5	35.5	1871
250	340	355L	991	95.8	0.84	432	2410.8	6.0	2.0	2.5	43.3	1978



Product Data

FOOT MOUNTED (IM B3) MOTOR DIMENSIONAL DRAWING

IE 1, IE 2 / IE 3

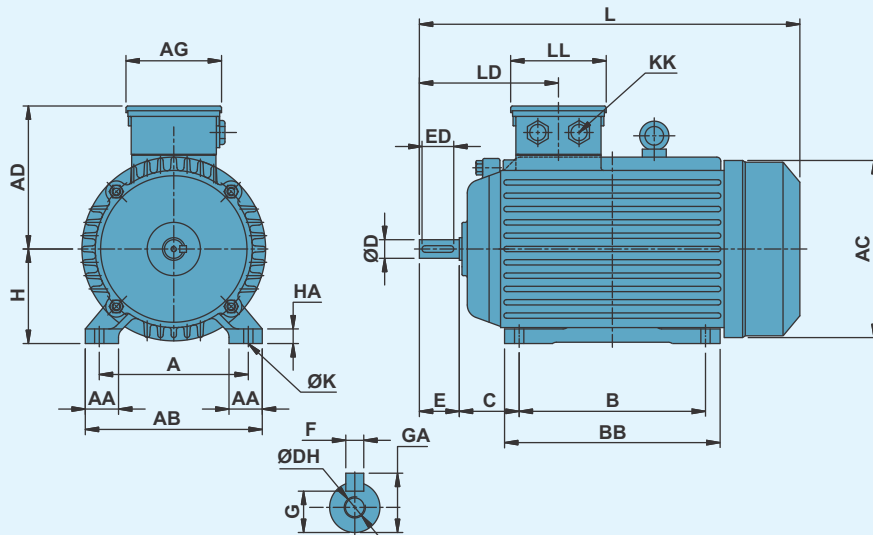

Frame	Pole	A	AA	AB	AC	AD	AG	B	BB	C	D	DH	E	ED	F	G	GA	H	HA	K	KK	L	LD	LL
71	2, 4, 6, 8	112	25	133	144	110	85	90	112	45	14	M5	30	25	5	11	16	71	11	7	1x3/4"	246	120	85
80	2, 4, 6, 8	125	38	155	171	125	85	100	126	50	19	M6	40	34	6	15.5	21.5	80	10	10	1x3/4"	284	140	85
90S	2, 4, 6, 8	140	36	168	178	149	98	100	158	56	24	M8	50	42	8	20	27	90	13	10	2x3/4"	333	148	98
90L	2, 4, 6, 8	140	36	168	178	149	98	100	158	56	24	M8	50	42	8	20	27	90	13	10	2x3/4"	333	148	98
100L	2, 4, 6, 8	160	38	195	194	156	98	140	170	63	28	M10	60	52	8	24	31	100	14	12	2x3/4"	371	157	98
112M	2, 4, 6, 8	190	42	230	218	169	98	140	170	63	28	M10	60	52	8	24	31	100	14	12	2x3/4"	398	160	98
132S	2, 4, 6, 8	216	65	257	262	192	131	140	182	89	38	M12	80	68	10	33	41	132	18	12	2x1"	459	202	131
132M	2, 4, 6, 8	216	65	257	262	192	131	178	220	89	38	M12	80	68	10	33	41	132	18	12	2x1"	497	202	131
160M	2, 4, 6, 8	254	55	305	304	244	171	210	260	108	42	M16	110	96	12	37	45	160	19	15	2x1"	597	282	195
160L	2, 4, 6, 8	254	55	305	304	244	171	254	300	108	42	M16	110	96	12	37	45	160	19	15	2x1"	637	282	195
180M	2, 4, 6, 8	279	66	342	357	296	265	241	284	121	48	M16	110	96	14	42.5	51.5	180	27	15	2xM40x1.5	720	280	195
180L	2, 4, 6, 8	279	66	342	357	296	265	279	340	121	48	M16	110	96	14	42.5	51.5	180	27	15	2xM40x1.5	758	280	195
200L	2, 4, 6, 8	318	86	400	392	308	265	305	360	133	55	M20	110	96	16	49	59	200	30	19	2xM50x1.5	806	288	195
225S	4, 6, 8	356	85	450	425	330	265	286	370	149	60	M20	140	122	18	53	64	225	32	19	2xM50x1.5	856	325	195
225M	2	356	85	450	425	330	265	311	395	149	55	M20	110	96	16	49	59	225	32	19	2xM50x1.5	851	295	195
	4, 6, 8	356	85	450	425	330	265	311	395	149	60	M20	140	122	18	53	64	225	32	19	2xM50x1.5	881	325	195
250M	2	406	90	480	493	382	286	349	414	168	60	M20	140	122	18	53	64	250	24	24	2xM63x1.5	881	355	253
	4, 6, 8	406	90	480	493	382	286	349	414	168	65	M20	140	122	18	58	69	250	24	24	2xM63x1.5	881	355	253
280S	2	457	100	540	548	445	325	368	490	190	65	M20	140	122	18	58	69	280	42	24	2xM63x1.5	1025	362	240
	4, 6, 8	457	100	540	548	445	325	368	490	190	75	M20	140	122	20	67.5	79.5	280	42	24	2xM63x1.5	1025	362	240
280M	2	457	100	540	548	445	325	368	490	190	65	M20	140	122	18	58	69	280	42	24	2xM63x1.5	1025	362	240
	4, 6, 8	457	100	540	548	445	325	368	490	190	75	M20	140	122	20	67.5	79.5	280	42	24	2xM63x1.5	1025	362	240
315S	2	508	123	635	625	519	284	406	570	216	65	M20	140	122	18	58	69	315	43	28	2xM63x1.5	1182	394	397
	4, 6, 8	508	123	635	625	519	284	406	570	216	80	M20	170	150	22	71	85	315	43	28	2xM63x1.5	1212	424	397
315M	2	508	123	635	625	519	284	457	680	216	65	M20	140	122	18	58	69	315	43	28	2xM63x1.5	1292	394	397
	4, 6, 8	508	123	635	625	519	284	457	680	216	80	M20	170	150	22	71	85	315	43	28	2xM63x1.5	1322	424	397
315L	2	508	123	635	625	519	284	508	680	216	65	M20	140	122	18	58	69	315	43	28	2xM63x1.5	1292	424	397
	4, 6, 8	508	123	635	625	519	284	508	680	216	80	M20	170	150	22	71	85	315	43	28	2xM63x1.5	1322	424	397
355M	2	610	120	700	725	603	380	560	827	254	70	M20	140	122	20	62.5	74.5	355	45	35	2xM63x1.5	1514	397	330
	4, 6, 8	610	120	700	725	603	380	560	827	254	100	M24	210	185	25	81	105	355	45	35	2xM63x1.5	1584	467	330
355L	2	610	120	700	725	603	380	630	827	254	70	M20	140	122	20	62.5	74.5	355	45	35	2xM63x1.5	1514	397	330
	4, 6, 8	610	120	700	725	603	380	630	827	254	100	M24	210	185	25	81	105	355	45	35	2xM63x1.5	1584	467	330

Note: All dimensions in mm unless otherwise noted.

Product Data

"C" TYPE FLANGE MOUNTED (IM B14) MOTOR DIMENSIONAL DRAWING

IE 1, IE 2 / IE 3

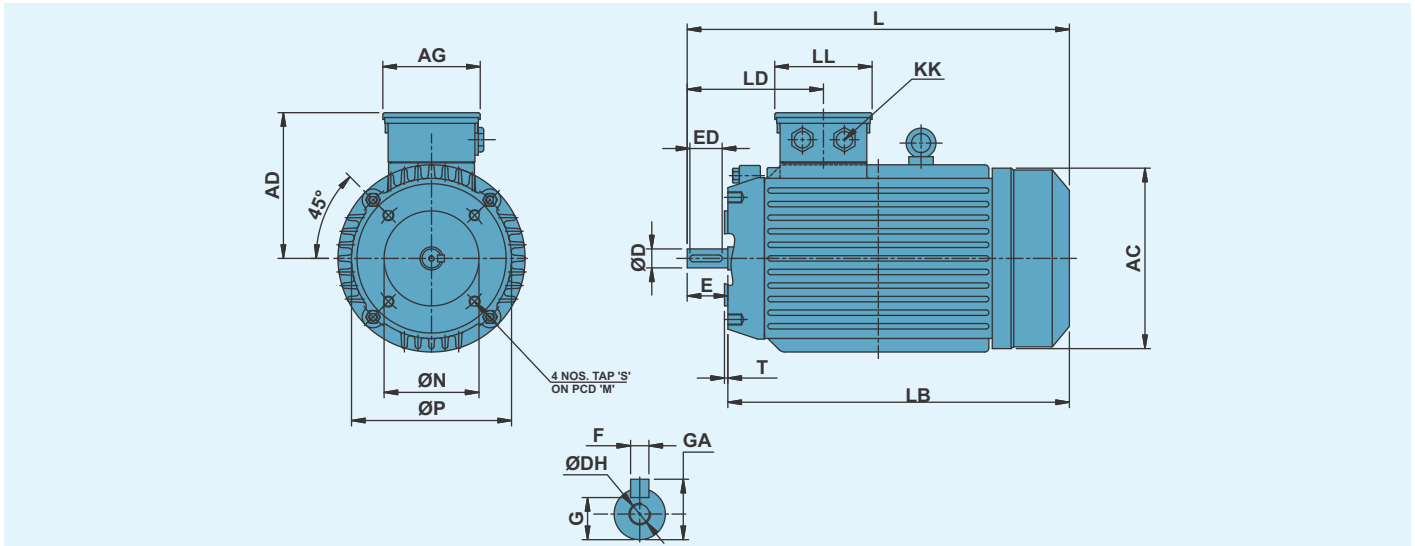

Frame	Pole	AC	AD	AG	D	DH	E	ED	F	G	GA	KK	L	LB	LD	LL	M	N	P	S	T
71	2, 4, 6, 8	144	110	85	14	M5	30	25	5	11	16	1x3/4"	246	216	120	85	85	70	105	M6	2.5
80	2, 4, 6, 8	171	140	98	19	M6	40	34	6	15.5	21.5	2x3/4"	284	244	140	98	100	80	120	M6	3
90S	2, 4, 6, 8	178	149	98	24	M8	50	42	8	20	27	2x3/4"	333	284	169	98	115	95	140	M8	3
90L	2, 4, 6, 8	178	149	98	24	M8	50	42	8	20	27	2x3/4"	333	284	169	98	115	95	140	M8	3
100L	2, 4, 6, 8	194	156	98	28	M10	60	52	8	24	31	2x3/4"	371	311	157	98	130	110	160	M8	3.5
112M	2, 4, 6, 8	218	169	98	28	M10	60	52	8	24	31	2x3/4"	398	338	160	98	130	110	160	M8	3.5
132S	2, 4, 6, 8	262	192	131	38	M12	80	68	10	33	41	2x1"	459	378	202	131	165	130	200	M10	3.5
132M	2, 4, 6, 8	262	192	131	38	M12	80	68	10	33	41	2x1"	497	417	202	131	165	130	200	M10	3.5
160M	2, 4, 6, 8	304	244	171	42	M16	110	96	12	37	45	2x1"	597	486	282	195	215	180	250	M12	4
160L	2, 4, 6, 8	304	244	171	42	M16	110	96	12	37	45	2x1"	637	527	282	195	215	180	250	M12	4

Note: All dimensions in mm unless otherwise noted.

Product Data

"B" TYPE FLANGE MOUNTED (IM B5) MOTOR DIMENSIONAL DRAWING

IE 1, IE 2 / IE 3

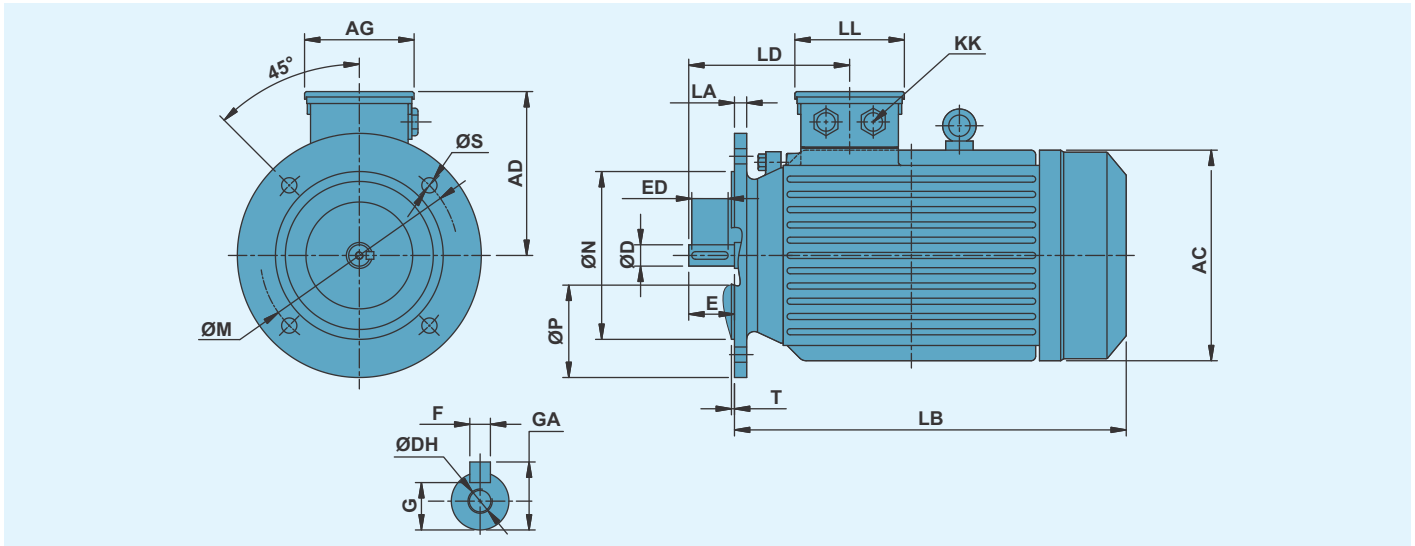

Frame	Pole	AC	AD	AG	D	DH	E	ED	F	G	GA	KK	L	LA	LB	LD	LL	M	N	P	S	T
71	2, 4, 6, 8	144	110	85	14	M5	30	25	5	11	16	1x3/4"	246	9	216	120	85	130	110	160	10	3.5
80	2, 4, 6, 8	171	140	98	19	M6	40	34	6	15.5	21.5	2x3/4"	284	10	244	140	98	165	130	200	12	3.5
90S	2, 4, 6, 8	178	149	98	24	M8	50	42	8	20	27	2x3/4"	333	10	284	169	98	165	130	200	12	3.5
90L	2, 4, 6, 8	178	149	98	24	M8	50	42	8	20	27	2x3/4"	333	10	284	169	98	165	130	200	12	3.5
100L	2, 4, 6, 8	194	156	98	28	M10	60	52	8	24	31	2x3/4"	371	11	311	157	98	215	180	250	15	4
112M	2, 4, 6, 8	218	169	98	28	M10	60	52	8	24	31	2x3/4"	398	12	338	160	98	215	180	250	15	4
132S	2, 4, 6, 8	262	192	131	38	M12	80	68	10	33	41	2x1"	459	13	378	202	131	265	230	300	15	4
132M	2, 4, 6, 8	262	192	131	38	M12	80	68	10	33	41	2x1"	497	13	417	202	131	265	230	300	15	4
160M	2, 4, 6, 8	304	244	171	42	M16	110	96	12	37	45	2x1"	597	13	486	282	195	300	250	350	19	5
160L	2, 4, 6, 8	304	244	171	42	M16	110	96	12	37	45	2x1"	637	13	527	282	195	300	250	350	19	5
180M	2, 4, 6, 8	357	296	265	48	M16	110	96	14	42.5	51.5	2xM40x1.5	720	18	610	280	195	300	250	350	19	5
180L	2, 4, 6, 8	357	296	265	48	M16	110	96	14	42.5	51.5	2xM40x1.5	758	18	649	280	195	300	250	350	19	5
200L	2, 4, 6, 8	392	308	265	55	M20	110	96	16	49	59	2xM50x1.5	806	16	696	288	195	350	300	400	19	5
225S	4, 6, 8	425	330	265	60	M20	140	122	18	53	64	2xM50x1.5	856	17	716	325	195	400	350	450	19	5
225M	2	425	330	265	55	M20	110	96	16	49	59	2xM50x1.5	851	17	741	295	195	400	350	450	19	5
	4, 6, 8	425	330	265	60	M20	140	122	18	53	64	2xM50x1.5	881	17	741	325	195	400	350	450	19	5
250M	2	493	382	286	60	M20	140	122	18	53	64	2xM63x1.5	881	19	741	355	253	500	450	550	19	5
	4, 6, 8	493	382	286	65	M20	140	122	18	58	69	2xM63x1.5	881	19	741	355	253	500	450	550	19	5
280S	2	548	445	325	65	M20	140	122	18	58	69	2xM63x1.5	1025	19	885	362	240	500	450	550	19	5
	4, 6, 8	548	445	325	75	M20	140	122	20	67.5	79.5	2xM63x1.5	1025	19	885	362	240	500	450	550	19	5
280M	2	548	445	325	65	M20	140	122	18	58	69	2xM63x1.5	1025	19	885	362	240	500	450	550	19	5
	4, 6, 8	548	445	325	75	M20	140	122	20	67.5	79.5	2xM63x1.5	1025	19	885	362	240	500	450	550	19	5
315S	2	625	519	284	65	M20	140	122	18	58	69	2xM63x1.5	1182	24	1042	394	397	600	550	660	24	6
	4, 6, 8	625	519	284	65	M20	170	150	22	71	85	2xM63x1.5	1212	24	1042	424	397	600	550	660	24	6
315M	2	625	519	284	65	M20	140	122	18	58	69	2xM63x1.5	1292	24	1152	394	397	600	550	660	24	6
	4, 6, 8	625	519	284	65	M20	170	150	22	71	85	2xM63x1.5	1322	24	1152	424	397	600	550	660	24	6
315L	2	625	519	284	65	M20	140	122	18	58	69	2xM63x1.5	1292	24	1152	424	397	600	550	660	24	6
	4, 6, 8	625	519	284	65	M20	170	150	22	71	85	2xM63x1.5	1322	24	1152	424	397	600	550	660	24	6
355M	2	725	603	380	70	M20	140	122	20	62.5	74.5	2xM63x1.5	1514	25	1374	467	330	740	680	800	24	6
	4, 6, 8	725	603	380	100	M24	210	185	25	81	105	2xM63x1.5	1584	25	1374	467	330	740	680	800	24	6
355L	2	725	603	380	70	M20	140	122	20	62.5	74.5	2xM63x1.5	1514	25	1374	467	330	740	680	800	24	6
	4, 6, 8	725	603	380	100	M24	210	185	25	81	105	2xM63x1.5	1584	25	1374	467	330	740	680	800	24	6

Note: All dimensions in mm unless otherwise noted.

IE 1

STANDARD EFFICIENCY

Frame size	Gross weight [kg]				Package dimensions [mm]	Gross volume [m ³]
	2 pole	4 pole	6 pole	8 pole		
63	8	8	-	-	300 x 235 x 185	0.013
71	15	10	-	-	300 x 235 x 185	0.013
80	22	16	18	-	320 x 235 x 205	0.015
90S	24	19	21	21	390 x 270 x 245	0.026
90L	28	22	23	24	390 x 270 x 245	0.026
100L	46	47	49	50	510 x 380 x 380	0.074
112M	52	55	55	55	510 x 380 x 380	0.074
132S	80	85	88	86	660 x 435 x 460	0.132
132M	93	101	108	-	660 x 435 x 460	0.132
160M	144	139	141	141	750 x 535 x 430	0.173
160L	182	166	156	163	800 x 535 x 430	0.184
180M	273	273	-	-	965 x 610 x 660	0.389
180L	-	289	280	290	965 x 610 x 660	0.389
200L	345	342	345	343	1020 x 635 x 690	0.447
225S	-	351	-	355	1070 x 635 x 740	0.503
225M	365	375	365	370	1070 x 635 x 740	0.503
250M	480	503	485	483	1095 x 660 x 865	0.625
280S	610	625	605	587	1270 x 790 x 1020	1.020
280M	680	721	655	653	1270 x 790 x 1020	1.020
315S	-	-	1030	1030	1410 x 830 x 1140	1.334
315M	-	-	1110	1130	1410 x 830 x 1140	1.410
315L	-	-	-	1185	1410 x 830 x 1140	1.438
355M	-	-	-	-	1740 x 950 x 1250	2.066
355L	-	-	-	-	1740 x 950 x 1250	2.066

SHIPPING DIMENSIONS

IE 2 / IE 3

HIGH / PREMIUM EFFICIENCY

Frame size	Gross weight [kg]						Package dimensions [mm]	Gross volume [m ³]
	IE 2			IE 3				
	2 pole	4 pole	6 pole	2 pole	4 pole	6 pole		
63	-	-	-	-	-	-	300 x 235 x 185	0.013
71	-	-	-	-	-	-	300 x 235 x 185	0.013
80	21	22	-	23	24	-	320 x 235 x 205	0.015
90S	26	27	27	29	30	30	390 x 270 x 245	0.026
90L	29	32	29	32	35	32	390 x 270 x 245	0.026
100L	55	61	54	61	67	59	510 x 380 x 380	0.074
112M	62	67	64	68	74	70	510 x 380 x 380	0.074
132S	101	98	96	111	108	106	660 x 435 x 460	0.132
132M	-	108	115	-	-	127	660 x 435 x 460	0.132
160M	161	162	175	177	178	193	750 x 535 x 430	0.173
160L	177	173	192	195	190	211	800 x 535 x 430	0.184
180M	248	247	-	260	259	-	965 x 610 x 660	0.389
180L	-	286	260	-	-	273	965 x 610 x 660	0.389
200L	328	337	318	344	354	334	1020 x 635 x 690	0.447
225S	-	383	-	-	-	-	1070 x 635 x 740	0.503
225M	421	413	390	442	434	410	1070 x 635 x 740	0.503
250M	515	528	512	541	554	538	1095 x 660 x 865	0.625
280S	655	645	628	688	677	659	1270 x 790 x 1020	1.020
280M	703	745	677	738	782	711	1270 x 790 x 1020	1.020
315S	1078	1080	1063	1132	1134	1116	1410 x 830 x 1140	1.334
315M	1139	1167	1143	1196	1225	1200	1410 x 830 x 1140	1.410
315L	1272	1355	1338	1336	1423	1405	1410 x 830 x 1140	1.438
355M	2088	1884	1782	2192	1978	1871	1740 x 950 x 1250	2.066
355L	2496	2090	1884	2621	2195	1978	1740 x 950 x 1250	2.066



GENERAL PUMPS

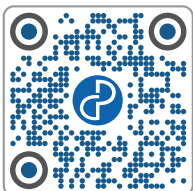

FOR MORE DETAILS
SCAN THE QR CODE

CONTACT US

GENERAL PUMPS, S.L.U.

📍 Pol. Ind. El Oliveral (U.E.7, Nave nº1) - Calle W 46394
Ribarroja del Turia - Valencia Spain

☎ Tel. : +34 96 1665200 / Fax : +34 96 1665052

✉ E-mail: info@pumpsgp.com

🌐 www.pumpsgp.com